



Technology Performance Report #2

Irvine Smart Grid Demonstration, a Regional Smart Grid Demonstration Project

Award Number: DE-OE0000199

Sponsoring Office:

U.S. Department of Energy – National Energy Technology Laboratory
Morgantown Campus
3610 Collins Ferry Road
P.O. Box 880
Morgantown, WV 26507-0880

Participant:

Southern California Edison Company – Advanced Technology
2131 Walnut Grove Avenue
Rosemead, CA 91770

Mark Irwin – Manager
Tel.: 714-895-0551
e-mail: mark.irwin@sce.com

Robert Yinger – Principal Investigator
Tel.: 714-379-7913
e-mail: robert.yinger@sce.com

Acknowledgement

This material is based upon work supported by the Department of Energy under Award Number DE-OE0000199.

Disclaimers

This report was prepared as an account of work sponsored by an agency of the United States Government. Neither the United States Government nor any agency thereof, nor any of their employees, makes any warranty, express or implied, or assumes any legal liability or responsibility for the accuracy, completeness, or usefulness of any information, apparatus, product, or process disclosed, or represents that its use would not infringe privately owned rights. Reference herein to any specific commercial product, process, or service by trade name, trademark, manufacturer, or otherwise does not necessarily constitute or imply its endorsement, recommendation, or favoring by the United States Government or any agency thereof. The views and opinions of authors expressed herein do not necessarily state or reflect those of the United States Government or any agency thereof.

This report was prepared by Southern California Edison Company (SCE) as an account of work sponsored by the Department of Energy, an agency of the United States Government, under Award Number DE-OE0000199. SCE, including any of their employees, affiliates and contractors, does not make any warranty, express or implied, or assume any legal liability or responsibility for the accuracy, completeness, or usefulness of any information, apparatus, product, or process disclosed, or represents that its use would not infringe privately owned rights. Reference herein to any specific commercial product, process, or service by trade name, trademark, manufacturer, or otherwise does not necessarily constitute or imply its endorsement, recommendation, or favoring by SCE. The views and opinions of authors expressed herein do not necessarily state or reflect those of SCE.

Table of Contents

1. EXECUTIVE SUMMARY	8
2. SCOPE	13
2.1 PROJECT ABSTRACT	13
2.2 PROJECT OVERVIEW	13
2.2.1 Objectives.....	13
2.2.2 Project Team.....	14
2.2.3 Project Location	14
2.2.4 Project Schedule and Milestones	15
2.3 PROJECT DOMAINS	15
2.3.1 Smart Energy Customer Solutions.....	15
2.3.2 Next-Generation Distribution System	15
2.3.3 Interoperability & Cybersecurity	16
2.3.4 Workforce of the Future.....	16
2.4 SMART GRID FUNCTIONS AND ENERGY STORAGE APPLICATIONS	16
2.4.1 Smart Grid Functions	16
2.4.2 Energy Storage Applications	17
2.5 POTENTIAL BENEFITS	17
2.5.1 Economic Benefits.....	19
2.5.2 Reliability Benefits	20
2.5.3 Environmental Benefits.....	21
2.5.4 Security Benefits.....	21
2.6 PROJECT STAKEHOLDER INTERACTIONS.....	21
3. TECHNICAL APPROACH.....	23
3.1 SMART ENERGY CUSTOMER SOLUTIONS	23
3.1.1 Sub-project 1: Zero Net Energy Homes	23
3.1.2 Sub-project 2: Solar Car Shade.....	29
3.2 NEXT-GENERATION DISTRIBUTION SYSTEM.....	31
3.2.1 Sub-project 3: Distribution Circuit Constraint Management Using Energy Storage	31
3.2.2 Sub-project 4: Distribution Volt/VAR Control.....	32
3.2.3 Sub-project 5: Self-healing Distribution Circuits.....	35
3.2.4 Sub-project 6: Deep Grid Situational Awareness	38
3.3 INTEROPERABILITY & CYBERSECURITY	39
3.3.1 Sub-project 7: Secure Energy Net.....	40
3.3.2 Sub-project 7: Substation Automation 3.....	56
3.4 WORKFORCE OF THE FUTURE	61
3.4.1 Workforce Training	61
3.4.2 Organizational Assessment.....	63
4. RESULTS	64
4.1 SMART ENERGY CUSTOMER SOLUTIONS	64
4.1.1 Sub-project 1: Zero Net Energy Homes	64
4.1.2 Sub-project 2: Solar Car Shade.....	124
4.2 NEXT-GENERATION DISTRIBUTION SYSTEM.....	129
4.2.1 Sub-project 3: Distribution Circuit Constraint Management Using Energy Storage	129
4.2.2 Sub-project 4: Distribution Volt/VAR Control.....	130
4.2.3 Sub-project 5: Self-healing Distribution Circuits.....	134
4.2.4 Sub-project 6: Deep Grid Situational Awareness	137

4.3	INTEROPERABILITY & CYBERSECURITY	139
4.3.1	Sub-project 7: Secure Energy Net.....	139
4.3.2	Sub-project 7: Substation Automation 3.....	140
4.4	WORKFORCE OF THE FUTURE	140
5.	CONCLUSIONS.....	141
5.1	LESSONS LEARNED	141
5.1.1	Smart Energy Customer Solutions.....	141
5.1.2	Next-Generation Distribution System	147
5.1.3	Interoperability & Cybersecurity	148
5.1.4	Workforce of the Future.....	151
5.2	COMMERCIAL READINESS OF ISGD TECHNOLOGIES.....	152
5.3	CALLS TO ACTION	152
	APPENDICES.....	153
	APPENDIX 1: ABBREVIATIONS	153
	APPENDIX 2: BUILD METRICS.....	156
	APPENDIX 3: INSTRUMENTATION FOR HOME DATA COLLECTION.....	160
	APPENDIX 4: PROJECT HOME FLOOR PLANS	165
	APPENDIX 5: ZNE FLYER SAMPLE	169
	APPENDIX 6: DATA STORAGE REQUIREMENTS.....	171
	APPENDIX 7: DEEP GRID SITUATIONAL AWARENESS ADAPTIVE FILTER AND ANN ALGORITHM DESIGN.....	175

Table of Figures

FIGURE 1: HIGH LEVEL PROJECT MAP	14
FIGURE 2: AERIAL VIEW OF ZNE BLOCK.....	23
FIGURE 3: WORKPLACE ELECTRIC VEHICLE CHARGERS AND SOLAR PV STRUCTURE	29
FIGURE 4: DISTRIBUTION SYSTEM PROTECTION EVENT SEQUENCE AND TIMELINE	36
FIGURE 5: ISGD SERVICES DOMAINS	41
FIGURE 6: ISGD LOGICAL SYSTEM ARCHITECTURE	42
FIGURE 7: ISGD SYSTEM SECURITY ARCHITECTURE.....	46
FIGURE 8: COMMON CYBERSECURITY SERVICES MANAGEMENT CONSOLE	47
FIGURE 9: ISGD VISUALIZATION SYSTEM SAMPLE VIEW.....	48
FIGURE 10: ISGD SYSTEM NETWORK INFRASTRUCTURE OVERVIEW	49
FIGURE 11: IPSEC IN THE INTERNET PROTOCOL SUITE	55
FIGURE 12: SA-3 NETWORK ARCHITECTURE.....	57
FIGURE 13: ZNE BLOCK ELECTRIC ENERGY USE BREAKDOWN (NOVEMBER 1, 2013 TO OCTOBER 31, 2014)	67
FIGURE 14: RESU BLOCK ELECTRIC ENERGY USE BREAKDOWN (NOVEMBER 1, 2013 TO OCTOBER 31, 2014)	68
FIGURE 15: CES BLOCK ELECTRIC ENERGY USE BREAKDOWN (NOVEMBER 1, 2013 TO OCTOBER 31, 2014).....	69
FIGURE 16: CONTROL BLOCK ELECTRIC ENERGY USE BREAKDOWN (NOVEMBER 1, 2013 TO OCTOBER 31, 2014)	70
FIGURE 17: ZNE BLOCK NATURAL GAS ENERGY USE (NOVEMBER 1, 2011 TO OCTOBER 31, 2014).....	71
FIGURE 18: RESU BLOCK NATURAL GAS ENERGY USE (NOVEMBER 1, 2011 TO OCTOBER 31, 2014)	72
FIGURE 19: CES BLOCK NATURAL GAS ENERGY USE (NOVEMBER 1, 2011 TO OCTOBER 31, 2014)	73
FIGURE 20: CONTROL BLOCK NATURAL GAS ENERGY USE (NOVEMBER 1, 2011 TO OCTOBER 31, 2014)	74
FIGURE 21: ZNE BLOCK AGGREGATE HOME LOAD PROFILE (DAILY AVERAGE FOR DECEMBER 2013)	75
FIGURE 22: ZNE BLOCK AGGREGATE HOME LOAD PROFILE (DAILY AVERAGE FOR MARCH 2014).....	75
FIGURE 23: ZNE BLOCK AGGREGATE HOME LOAD PROFILE (DAILY AVERAGE FOR JUNE 2014)	76
FIGURE 24: ZNE BLOCK AGGREGATE HOME LOAD PROFILE (DAILY AVERAGE FOR SEPTEMBER 2014)	76

FIGURE 25: ZNE BLOCK AVERAGE HOME LOAD PROFILE (DAILY AVERAGE FOR DECEMBER 2013)	78
FIGURE 26: RESU BLOCK AVERAGE HOME LOAD PROFILE (DAILY AVERAGE FOR DECEMBER 2013)	78
FIGURE 27: CES BLOCK AVERAGE HOME LOAD PROFILE (DAILY AVERAGE FOR DECEMBER 2013)	79
FIGURE 28: ZNE BLOCK AVERAGE HOME LOAD PROFILE (DAILY AVERAGE FOR MARCH 2014)	80
FIGURE 29: RESU BLOCK AVERAGE HOME LOAD PROFILE (DAILY AVERAGE FOR MARCH 2014)	80
FIGURE 30: CES BLOCK AVERAGE HOME LOAD PROFILE (DAILY AVERAGE FOR MARCH 2014)	81
FIGURE 31: ZNE BLOCK AVERAGE HOME LOAD PROFILE (DAILY AVERAGE FOR JUNE 2014)	81
FIGURE 32: RESU BLOCK AVERAGE HOME LOAD PROFILE (DAILY AVERAGE FOR JUNE 2014)	82
FIGURE 33: CES BLOCK AVERAGE HOME LOAD PROFILE (DAILY AVERAGE FOR JUNE 2014)	82
FIGURE 34: ZNE BLOCK AVERAGE HOME LOAD PROFILE (DAILY AVERAGE FOR SEPTEMBER 2014)	83
FIGURE 35: RESU BLOCK AVERAGE HOME LOAD PROFILE (DAILY AVERAGE FOR SEPTEMBER 2014)	83
FIGURE 36: CES BLOCK AVERAGE HOME LOAD PROFILE (DAILY AVERAGE FOR SEPTEMBER 2014)	84
FIGURE 37: CES 7 LOAD PROFILES (DAILY AVERAGE FOR DECEMBER 2013)	84
FIGURE 38: ZNE SITE ENERGY STATUS FOR ZNE BLOCK HOMES (NOVEMBER 1, 2013 TO OCTOBER 31, 2014)	87
FIGURE 39: ZNE SOURCE ENERGY STATUS FOR ZNE BLOCK HOMES (NOVEMBER 1, 2013 TO OCTOBER 31, 2014)	90
FIGURE 40: ZNE SITE ELECTRIC ENERGY STATUS FOR ZNE BLOCK HOMES (NOVEMBER 1, 2013 TO OCTOBER 31, 2014)	91
FIGURE 41: ZNE SITE ENERGY STATUS FOR CES BLOCK HOMES (NOVEMBER 1, 2013 TO OCTOBER 31, 2014)	92
FIGURE 42: ZNE SOURCE ENERGY STATUS FOR CES BLOCK HOMES (NOVEMBER 1, 2013 TO OCTOBER 31, 2014)	93
FIGURE 43: ZNE SITE ELECTRIC ENERGY STATUS FOR CES BLOCK HOMES (NOVEMBER 1, 2013 TO OCTOBER 31, 2014)	94
FIGURE 44: ZNE SITE ENERGY STATUS FOR RESU BLOCK HOMES (NOVEMBER 1, 2013 TO OCTOBER 31, 2014)	95
FIGURE 45: ZNE SOURCE ENERGY STATUS FOR RESU BLOCK HOMES (NOVEMBER 1, 2013 TO OCTOBER 31, 2014)	96
FIGURE 46: ZNE SITE ELECTRIC ENERGY STATUS FOR RESU BLOCK HOMES (NOVEMBER 1, 2013 TO OCTOBER 31, 2014)	97
FIGURE 47: AVERAGE RESU POWER AND STATE OF CHARGE (SEPTEMBER 15, 2014)	104
FIGURE 48: RESU 5 LOAD SUMMARY (SEPTEMBER 15, 2014)	106
FIGURE 49: RESU STATES OF CHARGE (JULY 8, 2014)	109
FIGURE 50: SOLAR PV GENERATION OUTPUT (JULY 8, 2014)	110
FIGURE 51: RESU SECURE LOAD POWER LEVELS DURING OUTAGE (JULY 8, 2014)	111
FIGURE 52: CUMULATIVE SOLAR PV GENERATION	112
FIGURE 53: RESU HOME DEMAND (JULY 4, 2014)	113
FIGURE 54: SOLAR PV GENERATION AND EXPORT	114
FIGURE 55: CES PERMANENT LOAD SHIFTING PROFILES	116
FIGURE 56: MEASURED CES POWER VERSUS PLS PROFILE	116
FIGURE 57: LOAD PROFILES OF CES, CES BLOCK TRANSFORMER, AND CES BLOCK LOAD (SEPTEMBER 19, 2014)	117
FIGURE 58: CES ONE LINE DIAGRAM	118
FIGURE 59: CES BLOCK LOAD PROFILE (WEEK OF SEPTEMBER 1, 2014)	118
FIGURE 60: SOLAR PV GENERATION BY MONTH (MARCH 2014 THROUGH OCTOBER 2014)	119
FIGURE 61: AVERAGE SOLAR PV OUTPUT (OCTOBER 2013 TO MAY 2014)	121
FIGURE 62: SOLAR PV GENERATION (JUNE 17, 2014)	122
FIGURE 63: SOLAR PV GENERATION (JULY 22, 2014)	123
FIGURE 64: SOLAR CAR SHADE SYSTEM OVERVIEW	125
FIGURE 65: BESS WEEKDAY POWER PROFILE (OCTOBER 28, 2014)	127
FIGURE 66: VAR SUPPORT MODE (FEBRUARY 7, 2014)	132
FIGURE 67: SUBSTATION BUS VOLTAGES WITH DVVC IN CVR MODE (FEBRUARY 15, 2014 TO MARCH 15, 2014)	132
FIGURE 68: CUSTOMER VOLTAGES WITH AND WITHOUT DVVC (OCTOBER 17, 2014 TO OCTOBER 22, 2014)	133
FIGURE 69: DBESS CHARGE/DISCHARGE PROFILE (OCTOBER 24, 2014)	139
FIGURE 70: HOME DATA COLLECTION CABINET ARRANGEMENT	161
FIGURE 71: HOME DATA COLLECTION CABINET BLOCK DIAGRAM	161
FIGURE 72: REFERENCE MODEL EXAMPLE	173
FIGURE 73: REFERENCE MODEL EXAMPLE USING AN INTERMEDIATE TABLE	173
FIGURE 74: REAL POWER (MW)	178
FIGURE 75: FREQUENCY (HERTZ)	178
FIGURE 76: PHASE ANGLE DIFFERENCES BETWEEN BUS 0 IN DEVERS SUBSTATION AND ADJACENT SUBSTATIONS	179

FIGURE 77: ARNOLD CIRCUIT REAL POWER FOR ONE HOUR STARTING AT 2:16:58 ON 12/5/13.....	180
FIGURE 78: ROMMEL CIRCUIT REAL POWER FOR ONE HOUR STARTING AT 2:16:58 ON 12/5/13.....	180
FIGURE 79: NEURAL NETWORK TRAINING SUMMARY	181
FIGURE 80: NEURAL NETWORK TRAINING RESULTS FOR ARNOLD CIRCUIT	182
FIGURE 81: ERROR HISTOGRAM FOR ARNOLD CIRCUIT.....	183
FIGURE 82: ARNOLD CIRCUIT REAL POWER STARTING AT 4 PM (2/9/14).....	184
FIGURE 83: OVERALL SOLUTION METHOD I.....	185
FIGURE 84: OVERALL SOLUTION METHOD II.....	186
FIGURE 85: OVERALL SOLUTION METHOD III.....	187

TABLE OF TABLES

TABLE 1: ISGD LESSONS LEARNED	11
TABLE 2: KEY ISGD MILESTONES.....	15
TABLE 3: SUMMARY OF SMART GRID FUNCTIONS BY SUB-PROJECT	16
TABLE 4: SUMMARY OF ENERGY STORAGE APPLICATIONS BY SUB-PROJECT.....	17
TABLE 5: SUMMARY OF ISGD BENEFITS BY SUB-PROJECT	18
TABLE 6: SUMMARY OF STAKEHOLDER INTERACTIONS	21
TABLE 7: SUB-PROJECT 1 TEST GROUP DESIGNS.....	24
TABLE 8: IDSM MEASURES BY TEST GROUP	25
TABLE 9: DEMAND RESPONSE COMPONENTS.....	28
TABLE 10: PRIMARY VOLTAGE CONTROL RANGES	33
TABLE 11: SENET RESOURCES AND SERVICES SHARING	41
TABLE 12: ISGD USE OF INTEROPERABILITY STANDARDS.....	43
TABLE 13: ISGD SOFTWARE APPLICATIONS.....	50
TABLE 14: SITE-TO-SOURCE CONVERSION FACTORS FOR ELECTRICITY AND NATURAL GAS	85
TABLE 15: ACTUAL VERSUS FORECASTED ZNE SITE ENERGY STATUS FOR THE ZNE BLOCK HOMES.....	87
TABLE 16: ACTUAL VS. FORECASTED NATURAL GAS AND ELECTRICITY USE PERCENTAGES FOR ZNE BLOCK HOMES (SITE ENERGY)	88
TABLE 17: ACTUAL VERSUS FORECASTED SOLAR PV SITE ENERGY GENERATION FOR THE ZNE BLOCK HOMES	89
TABLE 18: ROOFLINE SLOPE AND ORIENTATION FOR THE ZNE BLOCK HOMES	89
TABLE 19: SOURCE VERSUS SITE ENERGY ZNE STATUS FOR THE ZNE BLOCK HOMES.....	90
TABLE 20: SITE ENERGY VERSUS SITE ELECTRIC ENERGY ZNE STATUS FOR THE ZNE BLOCK HOMES	91
TABLE 21: SITE VERSUS SOURCE VERSUS SITE ELECTRIC ENERGY ZNE STATUS FOR THE ZNE BLOCK HOMES	91
TABLE 22: SITE ENERGY VERSUS SOURCE ENERGY ZNE STATUS FOR THE CES BLOCK HOMES.....	93
TABLE 23: SITE ELECTRIC VERSUS SITE ENERGY ZNE STATUS FOR THE CES BLOCK HOMES.....	94
TABLE 24: SITE VERSUS SOURCE VERSUS SITE ELECTRIC ENERGY ZNE STATUS FOR THE CES BLOCK HOMES.....	94
TABLE 25: SOURCE VERSUS SITE ENERGY ZNE STATUS FOR THE RESU BLOCK HOMES.....	96
TABLE 26: SITE ELECTRIC VERSUS SITE ENERGY ZNE STATUS FOR THE RESU BLOCK HOMES.....	97
TABLE 27: SITE VS. SOURCE VS. SITE ELECTRIC ENERGY ZNE STATUS FOR THE RESU BLOCK HOMES.....	97
TABLE 28: PCT BEHAVIOR (JULY 24, 2014)	98
TABLE 29: EVSE BEHAVIOR (JULY 24, 2014).....	99
TABLE 30: PCT BEHAVIOR (JULY 28, 2014)	100
TABLE 31: EVSE BEHAVIOR (JULY 28, 2014).....	101
TABLE 32: PCT BEHAVIOR (JULY 29, 2014)	102
TABLE 33: EVSE BEHAVIOR (JULY 29, 2014).....	102
TABLE 34: DR EVENT DETAILS FOR SEPTEMBER 15, 2014	103
TABLE 35: PCT BEHAVIOR (SEPTEMBER 15, 2014).....	104
TABLE 36: EVSE BEHAVIOR (SEPTEMBER 15, 2014).....	106
TABLE 37: EVSE BEHAVIOR (SEPTEMBER 18, 2014).....	107
TABLE 38: SUB-METERED PEV CHARGING ACTIVITY	124

TABLE 39: SOLAR CAR SHADE SYSTEM MEASUREMENT POINTS	125
TABLE 40: SOLAR CAR SHADE SYSTEM PERFORMANCE	125
TABLE 41: DVVC CVR RESULTS (OCTOBER 6, 2014 TO NOVEMBER 10, 2014)	133
TABLE 42: URCI COMMISSIONING CHALLENGES	136
TABLE 43: READINGS TYPES IN COLUMNS EXAMPLE	171
TABLE 44: READING TYPES IN VALUES EXAMPLE	172

1. Executive Summary

With a vision of safely providing a more reliable and affordable electric system, Southern California Edison Company (SCE) has been awarded up to \$39.6 million in matching funds from the U.S. Department of Energy (DOE) to conduct the Irvine Smart Grid Demonstration (ISGD). This demonstration is testing the interoperability and effectiveness of key elements of the electric grid—from the transmission level through the distribution system and into the customer premises. This end-to-end demonstration of smart grid technologies is helping SCE address several profound changes impacting the electric grid’s operation, including increased use of renewable resources, more intermittent generation connecting to the distribution system, the ability of customers to actively manage the way they use electricity, and policies and mandates focused on improving the environment and promoting energy security.

Project Overview

ISGD operates primarily in the City of Irvine (Irvine) in Orange County, California, and many of the project components are located on or near the University of California, Irvine (UCI) campus. Key project participants include UCI, General Electric, SunPower Corporation, LG Chem, Space-Time Insight, and the Electric Power Research Institute.

ISGD’s evaluation approach includes four distinct types of testing: simulations, laboratory tests, commissioning tests, and field experiments. ISGD uses simulations and laboratory testing to validate a technology’s performance capabilities prior to field installation. The purpose of the field experiments is to evaluate the physical impacts of the various technologies on the electric grid and to quantify the associated benefits.

The project includes four domains. Each domain includes one or more sub-projects with distinct objectives, technical approaches, and research plans. There are eight sub-projects within these four domains.

1. Interoperability & Cybersecurity
2. Next-Generation Distribution System
3. Smart Energy Customer Solutions
4. Workforce of the Future

Interoperability & Cybersecurity

The electric grid is evolving to include an increasing number of distributed and interconnected grid resources, both utility- and customer-owned. The need for plug-and-play interoperability within a secure environment is therefore of critical importance. The project is using SCE’s MacArthur Substation to pilot its next generation of substation automation (SA-3). The SA-3 platform enables standards-based communications, automated configuration of substation devices, and an enhanced system protection design. The team set up a complete duplicate of the equipment installed in MacArthur Substation at SCE’s Advanced Technology Labs in order to perform real-time simulations and component testing prior to field installation. Real-time simulation allowed testing of thousands of scenarios to verify proper operation under various grid conditions. The team has installed SA-3 components at MacArthur Substation and the system is now in service.

MacArthur Substation also represents the first field deployment of SCE’s Common Cybersecurity Services (CCS) platform. ISGD is using CCS to provide high-assurance cybersecurity for substation devices and communications between the various field devices and ISGD back office systems. The team prepared detailed requirements and system design documents. The team assembled various communications and security components in the laboratory environment for end-to-end integration testing prior to field deployment. The team then installed the various components in the field and commissioned the system.

Next-Generation Distribution System

The electric grid is evolving into an increasingly dynamic system with new types of distributed and variable generation resources and changing customer demands. This project domain includes technologies designed to help support grid resiliency and efficiency within this changing environment. Two 12 kilovolt (kV) circuits fed from MacArthur Substation are demonstrating a set of advanced distribution automation technologies.

ISGD is using a distribution volt/VAR control (DVVC) application to optimize customer voltage profiles in pursuit of *conservation voltage reduction*. DVVC can also provide volt-ampere reactive (VAR) support to the transmission system. The DVVC application underwent multiple rounds of factory acceptance testing and site acceptance testing, and is now operating on seven distribution circuits out of MacArthur Substation.

ISGD's self-healing distribution circuit should improve reliability by identifying and isolating faults with greater speed and precision. This ISGD capability isolates faults within a smaller section of a distribution circuit while preserving service to the remaining customers. The self-healing distribution circuit uses a looped circuit topology with universal remote-controlled circuit interrupters (URCIs). During a fault, the URCIs coordinate their operations using Generic Object Oriented Substation Event (GOOSE) messaging through high-speed, low-latency radios. The team performed simulations of the URCI system operating under a variety of grid conditions to evaluate its performance prior to field deployment. The team also performed pre-deployment testing of the URCI and radio components in preparation for field deployment.

ISGD is operating a 2 megawatt (MW) energy storage device to help relieve distribution circuit constraints and to mitigate overheating of the substation getaway. This battery is also being used along with phasor measurement technology installed within MacArthur Substation and a transmission-level substation (upstream of MacArthur Substation) to try to detect changes in distribution circuit load from distributed energy resources (such as demand response resources or energy storage). The team performed lab testing of the battery system to prepare for field deployment.

Smart Energy Customer Solutions

Customers are modifying how they consume and generate electricity. This project domain includes a variety of technologies designed to help empower customers to make informed decisions about their energy use. The project extends into a residential neighborhood on the UCI campus used for faculty housing. ISGD has equipped three blocks of homes with an assortment of advanced energy components, including energy efficiency upgrades, electric vehicle supply equipment (EVSE), energy storage, rooftop solar photovoltaic (PV) panels, thermostats and smart appliances capable of demand response, and in-home displays. The project is using one block of homes to evaluate strategies and technologies for achieving zero net energy (ZNE). A home achieves ZNE when it produces at least as much renewable energy as the amount of energy it consumes on an annual basis. The project is also seeking to understand the impact of ZNE homes on the electric grid. The team performed energy simulations to determine the energy efficiency measures for each home. The project team performed laboratory testing on the smart appliances, EVSE, and other home area network (HAN) devices prior to field deployment. In the field, the team has performed demand response experiments on the EVSE, smart appliances, and the heating and cooling systems. To evaluate the ZNE technology and strategies, the team is collecting detailed energy usage information, by circuit.

ISGD is evaluating two types of energy storage devices in this neighborhood. The team has installed residential energy storage units (RESUs) in 14 homes, and is evaluating them using a variety of control modes. In addition, one block of homes shares a community energy storage (CES) device. The team is also evaluating the CES using a variety of control modes. Both devices can provide a limited amount of backup power during electricity outages. These energy storage devices underwent extensive laboratory testing prior to commissioning. The team then installed the devices and performed initial field experiments, including a demand response event and a series of load shifting tests.

To evaluate the impact of charging plug-in electric vehicles (PEVs) in the workplace, ISGD has installed a Solar Car Shade system within a parking garage on the UCI campus. The system includes 48 kilowatts (kW) of rooftop solar PV, 20 EVSEs, and a 100 kW/100 kilowatt-hours (kWh) energy storage device. The objective is to reduce or eliminate the grid impact of PEV charging during peak periods. The team performed component testing of the energy storage device and EVSEs prior to installation. The team then commissioned the system and performed an initial permanent load shifting (PLS) test over an eight-week period.

Workforce of the Future

Deploying smart grid technologies on a larger scale would affect the utility workforce, and it could have implications for the utility's organizational structure. The project team has developed workforce training for the relevant ISGD technologies. The team is also performing an organizational assessment to identify potential organizational impacts, and to develop recommendations for addressing those impacts.

Reporting Overview

Over the course of the project, SCE is filing two Technology Performance Reports (TPRs) and a Final Technical Report. This document represents the second TPR, which addresses the results from the second eight-month experimentation period. The Final Technical Report will cover the entire two-year demonstration period. The final report will also provide benefit calculations and an appraisal of the commercial readiness and scalability of the technologies demonstrated.

Technology Performance Report Organization

Chapter 2 provides general information about the project, including overviews of the project team, location, schedule, and milestones. This chapter also provides additional details about the four project domains introduced above, and it summarizes the potential benefits that could result from the ISGD technologies.

Chapter 3 describes the objectives, technical approach, and research plan for each sub-project. The research plan describes the relevant technology evaluation activities including simulations, laboratory tests, commissioning tests, and field experiments for each of the technology components.

Chapter 4 summarizes the demonstration results for the second eight-months of field experimentation—from March 1, 2014 to October 31, 2014. The first TPR documents the results of ISGD's design and deployment and the first eight-months of field experimentation—from July 1, 2013 to February 28, 2014.

Chapter 5 summarizes the conclusions and key lessons learned from the design, deployment, and second eight-month period of field experiments.

Key Lessons Learned

Table 1 below summarizes the key lessons learned during the design, deployment, and first sixteen months of field experiments. The ISGD team is accumulating additional observations, and intends to present more lessons learned in the Final Technical Report. The Final Technical Report will provide assessments of the commercial readiness and scalability of the various ISGD technologies. It will also provide specific recommendations and "calls to action" for relevant industry stakeholders, including utility executives, policymakers and regulators (federal and state), standards developing organizations, industry research organizations, and the vendor and service provider communities.

Table 1: ISGD Lessons Learned

ISGD Technology Domains/Lessons Learned	Lessons Learned Categories				
	Standards	Technical Maturity	Regulatory Landscape	Market Landscape	Deployment /Integration
Smart Energy Customer Solutions					
1. Smart inverter standards are too immature to support product development and market adoption	✓				
2. Proper integration of components from multiple vendors is critical to the successful operation of energy storage systems		✓			
3. Improved battery system diagnostic capabilities are required to help identify the causes of failures		✓			
4. Manufacturer implementations of the SAE J1772 EVSE standard limit the usefulness of electric vehicle demand response	✓	✓			
5. Distributed energy resources should be designed and tested to ensure communications and operations compatibility with utility control systems		✓			✓
6. Remotely monitoring new technologies after field deployment is critical to timely identification and resolution of unknown issues					✓
7. Targeted “behind the meter” data collection will help future demonstration analytics					✓
8. Consistent implementation of Smart Energy Profile demand response messaging across customer device types would simplify aggregated demand response	✓				
9. Assessing the impacts of energy efficiency measures requires isolating customer behavioral changes					✓
10. When deploying systems with components from multiple vendors, a careful commissioning plan should be constructed					✓
11. Energy storage degradation should be factored into device control algorithms and relevant utility load management tools		✓			
12. Demand response devices should be capable of decreasing and increasing energy demand	✓			✓	
13. Energy storage that supports islanding should be sized appropriately and should only island during actual grid outages	✓				✓
14. Back-up power for data acquisition systems should be provided when data collection is needed during power outages					✓

Next-Generation Distribution System					
1. Low-latency radios require technical improvements or government allocation of radio spectrum		✓	✓		
2. Permitting is a significant challenge for siting smart grid field equipment outside of utility rights-of-way			✓		
3. Radio communications-assisted distribution circuit protection schemes are difficult to implement	✓				✓
4. Distribution volt/VAR control applications should be aware of system configuration changes to maximize CVR benefits					✓
5. Distribution volt/VAR control capabilities can achieve greater benefits when combined with management of transmission substation voltage schedules					✓
Interoperability & Cybersecurity					
1. Continued development of the IEC 61850 standard and vendor implementations of this standard are required to achieve a mature state of interoperability	✓			✓	✓
2. Achieving interoperability requires concentrated market-based development and enforcement of industry standards	✓			✓	
3. An enterprise service bus can simplify the development and operation of visualization capabilities		✓			
4. Utilities need to perform a system integrator role in order to realize smart grid objectives					✓
5. Effective communications with software vendors is critical for smart grid deployments					✓
6. Acceptance testing should include integrated testing of software products and field devices in a lab environment					✓
Workforce of the Future					
1. Impacts to departmental boundaries and worker roles and responsibilities that result from smart grid deployments need to be identified and resolved					✓
2. Build time into any smart grid deployment planning for an iterative training development process					✓

2. Scope

Southern California Edison Company (SCE) has been awarded up to \$39.6 million in matching funds from the U.S. Department of Energy (DOE) to conduct a Regional Smart Grid Demonstration Project, an end-to-end demonstration of numerous smart grid technologies that SCE believes are necessary to meet federal and state policy goals. The Irvine Smart Grid Demonstration (ISGD) project is testing the interoperability and efficacy of key elements of the grid, from the transmission level through the distribution system and into the home. SCE's experience with smart grid technologies, gained through the Avanti distribution circuit (co-funded by the DOE¹), synchrophasor development, and the Edison SmartConnect® smart meter program, to name a few, provides an important foundation for this project. ISGD is a deep vertical dive that tests multiple components of an end-to-end smart grid. Thus, the project provides a living laboratory for simultaneously demonstrating and assessing the interoperability of, and interaction between, various smart grid technologies and systems. ISGD operates in the City of Irvine (Irvine), a location that typifies some heavily populated areas of Southern California in climate, topography, environmental concerns, and other public policy issues.

2.1 Project Abstract

ISGD is a comprehensive demonstration that spans the electricity delivery system and extends into customer homes. The project is using phasor measurement technology to enable substation-level situational awareness, and is demonstrating SCE's next-generation substation automation system. It extends beyond the substation to evaluate the latest generation of distribution automation technologies, including looped 12-kilovolt (kV) distribution circuit topology using universal remote-controlled circuit interrupters (URCIs). The project team is using distribution volt/volt-ampere reactive (VAR) control (DVVC) capabilities to demonstrate conservation voltage reduction (CVR). In customer homes, the project is evaluating home area network (HAN) devices such as smart appliances, programmable communicating thermostats, and home energy management components. The homes also include energy storage, solar photovoltaic (PV) systems, and a number of energy efficiency measures (EEMs). The team is using one block of homes to evaluate strategies and technologies for achieving zero net energy (ZNE). A home achieves ZNE when it produces at least as much renewable energy as the amount of energy it consumes annually. The project is also assessing the impact of device-specific demand response (DR), as well as load management capabilities involving energy storage devices and plug-in electric vehicle charging equipment. In addition, the ISGD project is seeking to better understand the impact of ZNE homes on the electric grid. ISGD's Secure Energy Network (SENet) enables end-to-end interoperability between multiple vendors' systems and devices, while also providing a level of cybersecurity that is essential to smart grid development and adoption across the nation.

The ISGD project includes a series of sub-projects grouped into four logical technology domains: Smart Energy Customer Solutions, Next-Generation Distribution System, Interoperability and Cybersecurity, and Workforce of the Future. Section 2.3 provides a more detailed overview of these domains.

2.2 Project Overview

2.2.1 Objectives

The primary objective of ISGD is to verify and evaluate the ability of smart grid technologies to operate effectively and securely when deployed in an integrated framework. The project also provides a means to quantify the costs and benefits of these technologies in terms of overall energy consumption, operational efficiencies, and societal

¹ This is a 12 kV distribution circuit that became operational in 2007 and serves more than 1,400 residential and business customers.

and environmental benefits. Finally, ISGD allows the project team to test and validate the applicability of the demonstrated smart grid elements for the Southern California region and the nation as a whole.

2.2.2 Project Team

Project participants, led by SCE, consist of a combination of industry leaders, with each one bringing essential expertise to the project. In addition to SCE, major participants currently include the University of California, Irvine (UCI) Advanced Power and Energy Program, General Electric (GE), SunPower Corporation, Space-Time Insight (STI), and the Electric Power Research Institute (EPRI). SCE is coordinating the efforts among project participants to capture and document “lessons learned” and to help share this knowledge with the broader industry.

2.2.3 Project Location

ISGD operates primarily in Irvine, in Orange County California, approximately 35 miles south of the City of Los Angeles. With a population of nearly 250,000 people, Irvine is widely recognized as one of the safest master-planned, business-friendly communities in the country. It is home to UCI and a number of corporations, including many in the technology sector.

ISGD is being carried out on two 12 kV distribution circuits (Arnold and Rommel circuits) that are fed by MacArthur Substation located in the City of Newport Beach, California. MacArthur Substation is supplied by Santiago Substation located 10 miles east in Irvine. In addition to the two circuits fed by MacArthur Substation, portions of the ISGD project are being conducted within 38 homes on the UCI campus (faculty housing), and at a UCI parking facility. **Figure 1** provides a graphical depiction of this smart grid system.

Figure 1: High Level Project Map



2.2.4 Project Schedule and Milestones

The following table represents a summary of ISGD’s key milestones.

Table 2: Key ISGD Milestones

Key Milestones	Milestone Dates
Submit National Environmental Policy Act application and receive Categorical Exclusion from DOE	07/19/2010
Submit Interoperability & Cybersecurity Plan to DOE	10/24/2011
Submit Project Management Plan to DOE	07/31/2012
Complete engineering design and specifications	12/31/2012
Begin 24 months of measurement and verification activities	07/01/2013
Submit updated Metrics & Benefits Reporting Plan to DOE	12/12/2013
Submit first Technology Performance Report	06/03/2014
Submit second Technology Performance Report	01/31/2015
Complete data analysis and submit Final Technical Report	12/29/2015

2.3 Project Domains

The ISGD project includes the following four domains: Smart Energy Customer Solutions, Next-Generation Distribution System, Interoperability & Cybersecurity, and Workforce of the Future. Each domain includes one or more sub-projects with distinct objectives, technical approaches, and research plans.

2.3.1 Smart Energy Customer Solutions

This project domain includes a variety of technologies that help empower customers to make informed decisions about how and when they consume (or produce) energy. ISGD is evaluating these customer technologies through the following two sub-projects:

- Sub-project 1: Zero Net Energy Homes through Smart Grid Technologies
- Sub-project 2: Solar Car Shade

2.3.2 Next-Generation Distribution System

The electric grid is evolving into an increasingly dynamic system with new types of distributed and variable generation resources and changing customer demands. This project domain includes technologies designed to support grid efficiency and resiliency within this changing environment. ISGD is evaluating these electricity distribution technologies through the following four sub-projects:

- Sub-project 3: Distribution Circuit Constraint Management Using Energy Storage
- Sub-project 4: Distribution Volt/VAR Control
- Sub-project 5: Self-healing Distribution Circuits
- Sub-project 6: Deep Grid Situational Awareness

2.3.3 Interoperability & Cybersecurity

The electric grid is evolving to include an increasing number of distributed and interconnected grid resources, both utility and customer-owned. The need for seamless interoperability within a secure environment is of critical importance. This project domain is a foundational element that underpins the development of smart grid capabilities. ISGD is evaluating interoperability and cybersecurity through sub-project 7, which is composed of two elements:

- Secure Energy Network
- Substation Automation 3

2.3.4 Workforce of the Future

This project domain consists of a single sub-project, Workforce of the Future (sub-project 8). This domain provides the workforce training tools and capabilities necessary to operate and maintain the various ISGD components. The sub-project is also evaluating the potential impacts of smart grid technologies on the utility's organizational structure. This assessment will relate principally to SCE, although it will also provide insights for the electric utility industry.

2.4 Smart Grid Functions and Energy Storage Applications

2.4.1 Smart Grid Functions

In providing guidance to demonstration grant recipients for preparing Technology Performance Reports (TPRs), the DOE presented a list of "Smart Grid Functions."² Table 3 indicates which of these smart grid functions ISGD is demonstrating, by sub-project.

Table 3: Summary of Smart Grid Functions by Sub-project

DOE Smart Grid Functions	Sub-project							
	1	2	3	4	5	6	7	8 ³
Fault Current Limiting								
Wide Area Monitoring, Visualization, & Control							✓	
Dynamic Capability Rating								
Power Flow Control			✓					
Adaptive Protection					✓			
Automated Feeder Switching					✓			
Automated Islanding and Reconnection	✓							
Automated Voltage & VAR Control				✓				
Diagnosis & Notification of Equipment Condition								
Enhanced Fault Protection					✓			
Real-time Load Measurement & Management						✓		
Real-time Load Transfer					✓			
Customer Electricity Use Optimization	✓	✓						

² Guidance for Technology Performance Reports, Regional Demonstrations, V1 – Draft Submittal, June 17, 2011 (page 2).

³ Sub-project 8 is related to the workforce training and organizational impacts associated with smart grid technology, and therefore does not perform a smart grid function.

2.4.2 Energy Storage Applications

The DOE’s guidance for preparing TPRs included a list of potential “Energy Storage Applications.”⁴ **Table 4** indicates which of these energy storage applications ISGD is demonstrating, by sub-project.⁵

Table 4: Summary of Energy Storage Applications by Sub-project

Energy Storage Applications	Sub-project 1 RESU	Sub-project 1 CES	Sub-project 2 BESS	Sub-project 3 DBESS
Electric Energy Time Shift	✓	✓	✓	✓
Electric Supply Capacity	✓	✓	✓	✓
Load Following	✓	✓	✓	✓
Area Regulation				
Electric Supply Reserve Capacity				
Voltage Support	✓	✓		
Transmission Support				
Transmission Congestion Relief				
T&D Upgrade Deferral		✓	✓	
Substation Onsite Power				
Time-of-Use Energy Cost Management	✓		✓	
Demand Charge Management	✓		✓	
Electric Service Reliability	✓	✓		
Electric Service Power Quality				
Renewables Energy Time Shift	✓	✓	✓	
Renewables Capacity Firming				
Wind Generation Grid Integration, Short Duration				
Wind Generation Grid Integration, Long Duration				

2.5 Potential Benefits

The ISGD project is demonstrating smart grid technologies meant to improve the performance and resilience of the electric system. These performance improvements provide four categories of benefits: economic, reliability, environmental, and security. **Table 5** below summarizes the types of benefits the ISGD team expects to observe within the project. Evaluating an individual smart grid technology requires establishing linkages between the technology and the associated impacts. Moreover, these impacts should be measurable and verifiable. When deploying multiple technologies, the associated impacts must be isolated and assigned to the individual technologies. Evaluating the impacts of complementary technologies (or foundational technologies which enable other technologies) also requires careful consideration and evaluation. Limiting the project to a discrete and well-defined area removes many confounding sources of variation that can complicate isolating and measuring individual impacts. Nevertheless, the smart grid technologies may demonstrate considerable variability in their impacts or benefits due to factors outside the control of testing protocols.

Chapter 3 describes the ISGD research plans for each technology, and it defines the linkages between these technologies, the physical impacts they have on the system, and the potential corresponding benefits. The ISGD team plans to run the DOE’s Smart Grid Computational Tool to estimate the potential benefits resulting from ISGD. The ISGD project team may use other methods to estimate the benefits resulting from ISGD, and will document any such estimates in the Final Technical Report.

⁴ Guidance for Technology Performance Reports, Regional Demonstrations, V1 – Draft Submittal, June 17, 2011 (page 2).

⁵ **Table 4** summarizes the operational uses of the residential energy storage unit (RESU), community energy storage (CES), battery energy storage system (BESS), and distribution-level battery energy storage system (DBESS)

Table 5 summarizes the benefits that may be attributable to the smart grid technologies and capabilities demonstrated on ISGD. This table includes each of the smart grid benefits identified in the DOE benefits framework, as well an additional benefit identified by SCE.⁶

Table 5: Summary of ISGD Benefits by Sub-project⁷

Benefit Category	Benefit	Measurable Impacts	Sub-project							
			1	2	3	4	5	6	7	8
Economic Benefits										
Market Revenue	Arbitrage revenue		D							
	Capacity revenue									
	Ancillary service revenue									
Improved Asset Utilization	Optimized generator operation									
	Deferred generation capacity investments	Demand (kilowatts or kW)	D	D	D				I	I
	Reduced ancillary service cost									
	Reduced congestion cost									
T&D Capital Savings	Deferred transmission capacity investments		D	D	D				I	I
	Deferred distribution capacity investments	Demand (kW)	D	D	D				I	I
	Reduced equipment failures	<ul style="list-style-type: none"> • Demand (kW) • Customer voltage • # of equipment operations/failures 	D	D	D	D	D		I	I
T&D O&M Savings	Reduced distribution equipment maintenance cost	Equipment maintenance cost	D	D	D	D	D		I	
	Reduced distribution operations cost									
	Reduced meter reading cost	Identify sub-metering solution	D							
Theft Reduction	Reduced electricity theft									
Energy Efficiency	Reduced electricity losses	Feeder loading (kW)	D	D	D	D			I	I
Electricity Cost Savings	Reduced electricity cost	<ul style="list-style-type: none"> • Electricity use (kilowatt-hours or kWh) • Demand (kW) 	D	D		D		P	I	I

⁶ The DOE benefits framework was obtained from the DOE’s “SGDP Smart Grid Demonstration Program, Guidance for Technology Performance Reports,” June 17, 2011, page 3.

⁷ The following is a legend for the sub-project benefits:

- D Benefit is a direct result of this sub-project.
- I Benefit is an indirect result of this sub-project (i.e., sub-project enables the relevant capability within a different sub-project).
- P Benefit could potentially result from this sub-project. For example, sub-project 6 is demonstrating the potential for “deep grid situational awareness,” a capability would have no immediate or direct benefit, but could provide benefits over the longer term.

Benefit Category	Benefit	Measurable Impacts	Sub-project								
			1	2	3	4	5	6	7	8	
Reliability Benefits											
Reduced Service Interruption	Reduced sustained outages	<ul style="list-style-type: none"> # of outages Average outage duration 	D					D		I	I
	Reduced major outages										
	Reduced restoration cost	Time required to identify fault						D		I	I
Improved Power Quality	Reduced momentary outages	<ul style="list-style-type: none"> # of outages Average outage duration 	D					D		I	I
	Reduced sags and swells	Customer meter voltage					D				I
Environmental Benefits											
Reduced Air Pollution	Reduced carbon dioxide emissions	<ul style="list-style-type: none"> Plug-in Electric Vehicle (PEV) charging (kWh) Solar PV generation (kWh) Reduced electricity use (kWh) Reduced electricity loss (kWh) 	D	D	D	D				I	I
	Reduced SOx, NOx, and PM-2.5 emissions	<ul style="list-style-type: none"> PEV charging (kWh) Solar PV generation (kWh) Reduced electricity use (kWh) Reduced electricity loss (kWh) 	D	D	D	D				I	I
Security Benefits											
Improved Energy Security	Reduced oil usage	PEV charging (kWh)	D	D						I	I
Improved Cybersecurity⁸		<ul style="list-style-type: none"> Higher reliability Increased resiliency Improved situational awareness 								D	I

Sections 2.5.1 to 2.5.4 describe how the benefits identified in **Table 5** could eventually result from the technologies demonstrated within the ISGD project.

2.5.1 Economic Benefits

Deferred Generation Capacity Investments: Utilities determine their generation capacity requirements based on the need to serve the maximum forecasted load. Efforts to reduce peak load through demand response and other load management capabilities could ultimately defer the need for incremental generation capacity investments, if utilities expand these capabilities.

⁸ This benefit is not included in the DOE benefit framework.

Deferred Transmission Capacity Investments: Efforts to reduce peak load through demand response and other load management capabilities may reduce the load and stress on transmission infrastructure. This may result in deferring the need for incremental transmission capacity investments, if utilities expand these load management capabilities to large customer populations. Enabling distributed generation resources may also reduce the need for transmission capacity.

Deferred Distribution Capacity Investments: Distribution capacity requirements are generally determined based on non-coincident peak load. To the extent that new load management capabilities result in peak load reductions, it may be possible to defer distribution capacity investments.

Reduced Equipment Failures: Reducing the stress placed on distribution equipment has the potential to extend these assets' useful lives and reduce the number of equipment failures. Peak load reductions and enhanced fault protection can help to reduce distribution equipment stress.

Reduced Distribution Equipment Maintenance Cost: To the extent that enhancing circuit protection or reducing peak load reduce strain on distribution equipment, it may be possible to reduce the cost of maintaining this equipment.

Reduced Electricity Losses: As electricity travels from a generation source through the transmission and distribution system, a small portion of energy is lost due to system impedances. Conversely, locating generation resources closer to energy consumers can reduce energy losses. Lowering average customer voltage levels can also reduce electricity losses (i.e., CVR).

Reduced Electricity Cost: Energy efficiency measures installed within project participant homes, and CVR achieved through DVVC in sub-project 4 may contribute to overall reductions in electricity usage. Likewise, load management programs using direct load control of programmable communicating thermostats (PCTs), smart appliances, PEVs, and RESUs may support utility efforts to reduce peak load. Customers who enroll in time-of-use retail electricity rates or participate in load management programs would benefit financially from shifting their electricity use to off-peak periods.

2.5.2 Reliability Benefits

Reduced Sustained Outages: A sustained outage is an outage lasting more than 5 minutes. The self-healing distribution circuit in sub-project 5 may minimize the number of customers impacted by a fault condition. This should result in fewer sustained outages for customers served by this looped circuit. In addition, sub-project 1 includes two energy storage devices, the RESU and CES, which may help reduce the number of outages. The RESU is configured to support a circuit with secure loads (e.g., the garage door and refrigerator), such that these loads may continue to receive energy from the RESU during outages. Likewise, later in the project the team will configure the CES to provide an "islanding" capability to the homes on the CES Block during outages. In this case, the CES may provide electricity to this block of homes for a brief period.

Reduced Restoration Cost: The self-healing distribution circuit (i.e., the looped circuit in sub-project 5) has the potential to reduce the labor cost associated with restoring service following an outage. The looped circuit should automatically recognize when a fault occurs, identify and isolate the segment of the line that contains the fault, and reenergize the remaining segments of the looped circuit. This could result in less crew time in the field and lower vehicle fuel consumption since the field personnel would only have to search for the fault on the isolated circuit segment.

Reduced Momentary Outages: A momentary outage is an outage lasting less than 5 minutes. The looped circuit in sub-project 5 should identify the location of fault events and isolate the fault to a specific line segment, resulting in fewer momentary outages for customers on the looped circuit. The RESU and CES in sub-project 1 also have the ability to reduce momentary outages through their islanding and secure load backup capabilities.

Reduced Sags and Swells: Sags and swells refer to customer voltage levels that are above or below a defined range for a momentary duration. The DVVC capability in sub-project 4 dynamically controls customer voltage levels. However, since the DVVC algorithm operates every 5 minutes, it may not provide the voltage support necessary to mitigate all sags and swells on the associated distribution circuits.

2.5.3 Environmental Benefits

Reduced Carbon Dioxide Emissions: The ISGD project team expects to demonstrate three ways to reduce carbon dioxide emissions.

- Energy efficiency measures in the customer homes, and reducing the average customer voltage profile through DVVC both have the potential to reduce overall household energy usage. Reducing energy use would also reduce carbon dioxide emissions.
- Load management programs using PCTs, smart appliances, PEVs, and RESUs may help utilities avoid using “peaker” power plants (which generally burn natural gas) by reducing energy use during critical peak periods, and by shifting some energy consumption from peak to off-peak periods. Shifting energy consumption to off-peak periods has the potential to reduce carbon dioxide emissions, depending on the relative generation resource mix between these two periods.
- Replacing internal combustion vehicles with PEVs also has the potential to reduce carbon dioxide emissions.

Reduced SOX, NOX, and PM-2.5 Emissions: Reducing energy consumption, reducing peak demand, and shifting from internal combustion engine-based vehicle to PEVs may reduce SOX, NOX, and PM-2.5 emissions.

2.5.4 Security Benefits

Reduced Oil Usage: Reducing energy consumption, reducing peak demand, and shifting from internal combustion engine-based vehicle to PEVs, thereby decreasing consumption of petroleum-based fuels, would likely improve our nation’s energy security.

Improved Cybersecurity: Protecting the communication between smart grid devices, the utility, third-party service providers, and customers by incorporating an appropriate level of cybersecurity is a basic requirement and fundamental enabler of the smart grid.

2.6 Project Stakeholder Interactions

The ISGD project has a number of stakeholders, including the DOE’s National Energy Technology Laboratory (NETL), vendors, internal SCE stakeholders, and the participating homeowners. **Table 6** summarizes the major project stakeholders and the nature of their interactions with the project team.

Table 6: Summary of Stakeholder Interactions

Stakeholder	Interaction	Frequency
NETL	Since the project’s inception, the team has provided project updates to the Technical Project Officer during regularly scheduled meetings or more frequently as issues arise.	Bi-weekly and ad hoc
ISGD Project Team (SCE internal)	During the design and commissioning phases, each sub-project held regular meetings with the sub-project teams and any other relevant subject-matter experts. The project team also held regular meetings with the all sub-project leads to share project updates or issues across sub-projects.	Bi-weekly

Stakeholder	Interaction	Frequency
Advanced Technology Management (SCE internal)	The team provides project updates to the managers and directors in SCE's Advanced Technology organization on a regular basis.	Bi-monthly
ISGD Steering Committee (SCE internal)	The team provides project updates to directors of other SCE organizations that have touch points with ISGD (e.g., Field Engineering, Customer Programs and Services, etc.)	Quarterly
Vendors	The team meets with vendors either remotely or on-site to facilitate completing project deliverables.	Periodic project execution meetings
Industry Research Organizations	The team meets with UCI faculty and student researchers periodically to discuss research progress and test planning and execution. The team meets with EPRI periodically to discuss project progress, and SCE provides annual project updates at EPRI-hosted webinars.	Bi-weekly (UCI) Quarterly (EPRI) Annual (EPRI)
California Public Utilities Commission (CPUC)	The team meets with CPUC commissioners and staff on a periodic basis to provide general project updates.	Ad hoc
Homeowners	During project deployment, the team interacted with the project homeowners on a frequent basis (daily, during field installation). During the measurement and verification period, the team began preparing customized energy usage analysis reports for each homeowner on a monthly basis.	Monthly

3. Technical Approach

This chapter describes the approach for evaluating the various smart grid technologies included within ISGD's scope. As described in chapter 2, ISGD includes four domains: Smart Energy Customer Solutions, Next-Generation Distribution System, Interoperability & Cybersecurity, and Workforce of the Future. Each domain includes one or more sub-projects with distinct objectives, technical approaches, and research plans. This section summarizes the objectives, technical approaches, and research plans for each ISGD sub-project. Chapter 4 documents the results of these planned research activities.

3.1 Smart Energy Customer Solutions

ISGD is evaluating a variety of technologies designed to help empower customers to make informed decisions about how and when they consume (or produce) energy. Such technologies have the potential to better enable customers to manage their energy costs, while also improving grid reliability and stability. ISGD is evaluating these customer technologies through two sub-projects: sub-project 1: Zero Net Energy Homes and sub-project 2: Solar Car Shade.

3.1.1 Sub-project 1: Zero Net Energy Homes

Various state and federal policies, technological innovations, and customer interest are likely to drive changes in residential energy consumption patterns by the year 2020. Sub-project 1 is evaluating various combinations of integrated demand side management (IDSM) technologies to better understand their impacts on the electric grid, and their contributions toward enabling homes to achieve ZNE.⁹ ISGD includes four groups of project participant homes, including three test groups equipped with a variety of energy technologies, and a fourth group of homes used as a control group for experiment baselining purposes. All homes are located in the University Hills community on the UCI campus. The homes have two or three stories and range in size between 1,900 and 2,900 square feet. They have three to six bedrooms, three to three and a half bathrooms, and all have two-car garages. These homes were built between 2001 and 2002, and are located on a hillside with the lower floors built into the hill below street-level.

Figure 2: Aerial View of ZNE Block



3.1.1.1 Objectives

The objectives of this sub-project are to evaluate the impact of IDSM measures on customers' net energy consumption and usage patterns, and to assess the impact of these technologies on the grid.

3.1.1.2 Approach

This sub-project is demonstrating the integration of several IDSM measures intended to help customers achieve ZNE or near-ZNE. The measures can also help customers manage their energy use. For example, customers can store solar PV

⁹ IDSM measures include both energy efficiency measures and demand response capabilities.

generation for later use with energy storage devices, and they can reduce their peak energy consumption by participating in demand response events. IDSM measures include the following:

- Energy efficiency measures such as advanced lighting technologies, heating, ventilating and air conditioning (HVAC) technologies, smart appliances, and “building envelope” measures
- DR components such as PCTs, smart appliances, electric vehicle supply equipment (EVSEs), and RESUs
- A CES device
- Other customer technologies such as in-home displays (IHDs), home energy management system (home EMS), and solar PV generation

The project team is assessing the impacts of these measures by tracking consumer use of the individual components, in terms of both total energy consumption and usage patterns. Appendix 3 summarizes the approach to collecting this energy usage information.

The following tables summarize the measures applied to each sub-project 1 test group.

Table 7: Sub-project 1 Test Group Designs

Test Group 1: ZNE Block
<p>This represents the flagship test group for sub-project 1. The team outfitted these homes with a complete set of IDSM solutions, including energy efficiency upgrades, devices capable of demand response, a RESU, and a solar PV array. Table 8 summarizes these upgrades. In addition to NETL, the CPUC will also likely find these outcomes informative for developing a strategy to establish ZNE as a goal for new residential buildings built beginning in 2020. A home achieves ZNE when it produces at least as much renewable energy as the amount of energy it consumes annually, including both natural gas and electricity. This would require homes to consume approximately 65% less energy than homes built with the 2005 California Building Energy Efficiency Standards. The team installed solar PV panels on the rooftops, sized to make these homes ZNE or near-ZNE, given the project’s budget and roof-space limitations. The array sizes are approximately 4 kW based on the results of eQUEST simulations and the roof-space and budget limitations. After applying the cost-effective energy efficiency improvements and DR measures, the team sized the solar PV array to offset the remaining customer load. The RESUs are comprised of automotive-grade lithium ion cells, have nominal continuous power output ratings of 4 kW, and usable stored energy of 10 kWh. Additionally, the team installed plug load monitors and an electrical panel circuit monitoring system to measure energy consumption and demand. The team uses an Edison SmartConnect Itron sub-meter (sub-meter) to measure EVSE energy use, and an Edison SmartConnect Itron meter (smart meter) to monitor total household energy use. This meter is separate from SCE’s production billing meter. The smart appliances (refrigerator, dishwasher, and washing machine), communicating EVSE, PCT, and RESU all have demand response capabilities. These homes also have an IHD and a home EMS, which enable customer energy monitoring and control. IHDs are able to communicate instantaneous energy use, DR program status and pricing signals to customers in real-time.</p>
Test Group 2: RESU Block
<p>All homes in this test group include identical components, including a RESU, rooftop solar PV array, IHD, home EMS, and a set of DR-capable HAN technologies, including PCTs, smart appliances, and communicating EVSEs. The team is using a sub-meter to monitor the EVSE branch circuit, and plug load monitors and an electrical panel load monitoring system to monitor other important loads. These homes have not received any of the energy efficiency upgrades included in Test Group 1.</p>
Test Group 3: CES Block
<p>All homes in this test group include identical components, including the same solar PV generation and HAN technologies as Test Group 2. However, instead of having a RESU in each home, the homes share a CES device (25 kilovolt-amperes (kVA)/ 50 kWh) installed near the distribution transformer. These homes are equipped with a communicating EVSE and sub-meter on the EVSE branch circuit. Additionally, plug load monitors and an electrical panel circuit monitor system capture end use device energy and demand. Similar to Test Group 2,</p>

these homes did not receive any of the energy efficiency upgrades included in Test Group 1.

Test Group 4: Control Block

These homes act as a control group to provide baseline data for analysis purposes. These homes received no advanced energy technologies, except for a smart meter and device power monitors used to record end-use demand and energy consumption information.

Table 8 summarizes the IDSM measures for each of the sub-project 1 test groups.

Table 8: IDSM Measures by Test Group

Test Group		Vendor	ZNE Block	RESU Block	CES Block	Control Block
Participating Homes/ Homes on Block			9/9	6/8	7/9	16/20
Demand Response	Energy Star Smart Refrigerator	GE	8	6	7	0
	Energy Star Smart Clothes Washer ¹⁰	GE	8	6	7	0
	Energy Star Smart Dishwasher	GE	9	6	7	0
	Programmable Communicating Thermostat	GE	13	8	10	0
	Electric Vehicle Supply Equipment	BTC Power	9	6	7	0
	Home Energy Management System (home EMS)	GE	9	6	7	0
	In-Home Display	Aztech	9	6	7	0
Energy Efficiency Measures	Central Air Conditioning Replacement (Heat Pump)	Carrier	13	0	0	0
	Lighting Upgrades	Cree & George Kovacs	8	0	0	0
	Insulation	commodity insulation	8	0	0	0
	Efficient Hot Water Heater	A.O. Smith	2	0	0	0
	Domestic Solar Hot Water and Storage Tank	Heliodyne & Bradford White	7	0	0	0
	Low Flow Shower Heads	High Sierra Shower-heads	29	0	0	0
	Plug Load Timers	Belkin	40	0	0	0
Solar PV & Energy Storage	Community Energy Storage Unit	S&C Electric	0	0	1	0
	Residential Energy Storage Unit with Smart Inverter	LG Chem	9	5	0	0

¹⁰ Although this table lists the three smart appliances in the demand response section, these appliances support both demand response and energy efficiency.

Test Group		Vendor	ZNE Block	RESU Block	CES Block	Control Block
Participating Homes/ Homes on Block			9/9	6/8	7/9	16/20
	3.3 – 3.8 kW Solar PV Panels	SunPower	0	5	7 ¹¹	0
	3.9 kW Solar PV Panels	SunPower	9	0	0	0

3.1.1.3 Research Plan

3.1.1.3.1 Energy Simulations

The team has conducted energy simulations on the ZNE Block homes using the eQUEST modeling tool. The team performed these simulations in conjunction with the design process for the ZNE Block homes. The purpose of these simulations was to estimate the impact and cost-effectiveness of the various EEM options. After incorporating energy efficiency measures into the retrofit plans for each home according to the results of the eQUEST model, solar PV of sufficient capacity was identified for the project homes to achieve ZNE (or near ZNE) on a forecasted basis.

3.1.1.3.2 Laboratory Tests

Individual technology components were laboratory tested before installation in the field to verify performance and functionality based on the manufacturer specifications.

3.1.1.3.3 Commissioning Tests

The team performed a series of tests in the field to verify that the devices and components would perform their required functions per the manufacturers' specifications. The team performed these tests on four classes of field devices: monitoring devices, HAN devices, the RESU, and the CES.

The monitoring devices consist of the plug load monitors, temperature sensors, branch circuit monitors, project smart meters, and transformer monitors. These devices collect the data required for the field experiments. The commissioning tests consisted of verifying the ability of these devices to monitor and collect data generated by the project participant homes.

The HAN devices include three smart appliances (refrigerator, dishwasher, and clothes washer), IHDs, PCTs, and EVSEs. These devices present energy usage information to the project homeowners and enable utility load management capabilities. The commissioning tests consisted of verifying the ability to send and receive demand response event signals using ZigBee Smart Energy Profile 1.x.

RESU commissioning included the following two tests:

- **Utility Load Control:** The intent of this test was to demonstrate SCE's ability to send remote signals to the RESUs to control the full spectrum of charge and discharge capabilities, as well as static VAR absorb/supply functionality.
- **Secure Load Backup:** The homes with RESUs are able to connect pre-determined circuits to the RESU Secure Load connection. The RESU should protect these circuits from outage for a short duration. The team will not perform any outages to test this RESU feature, but it will evaluate the RESU performance during any unplanned outages.

The CES commissioning included the following two tests:

¹¹ Some homes on the CES Block already had rooftop solar panels prior to ISGD. The team installed between 1.3 kW and 3.8 kW on each CES Block home, such that each home now has between 3.3 kW and 3.8 kW.

- **Utility Load Control:** The intent of this test was to demonstrate SCE's ability to remotely control the CES's full spectrum of charge, discharge, and VAR inject/absorb functionalities. The team controlled the CES to charge and discharge real power, and to inject and absorb reactive power. Power quality monitors installed near the CES record data, confirm proper operation, and analyze the impact on the local grid. Part of the commissioning test was to verify that these data acquisition capabilities are operational.
- **Islanding:** The intent of this test was to confirm that the CES is able to provide an "islanding" capability following a grid outage. In the event of an outage, the CES may support the block's distribution transformer load using stored energy, and allow the homes' solar PV to continue generating energy. During any grid outage (or other event, such as short duration voltage sags or swells), locally installed power quality monitors and smart meters will record data. This data should confirm that the CES disconnects from the grid and begins supplying the required power to homes connected to the distribution transformer, provided the load is within the CES's 25-kVA rating. Upon grid power restoration, the monitoring devices will confirm that the CES has reconnected to the grid without causing any power quality disturbances. Over the course of the demonstration period, if an opportunity arises due to a maintenance event, the team may initiate a forced islanding event to perform this test.

3.1.1.3.4 Field Experiments

The ISGD team is performing the following experiments to evaluate the impacts of the sub-project 1 capabilities.

Field Experiment 1A: Impact of Integrated Demand Side Management Measures on Home and Grid

The objective of this experiment is to quantify the impact of energy efficiency upgrades and other IDSM measures on the home and transformer load profiles. The specific measures implemented vary by home. The measures may include all the items or a subset, depending on homeowner preference. The list of potential upgrades includes the following: light emitting diode (LED) lighting, heat pump, high efficiency hot water heater, domestic solar hot water system, plug load timers, low flow showers, duct sealant, increased attic insulation, ENERGY STAR smart appliances, solar PV array, RESU, and other HAN devices. This experiment should help the team determine how the homes on the ZNE Block perform against the goal of achieving zero net energy, measured over a one-year period. The savings will be determined by comparing the collected data to past billing cycles, simulation results, and the Test Group 4 (Control Block) electricity usage. The experiment should also help the team assess the impact of the energy efficiency upgrades and the other IDSM measures on the distribution transformer temperature and load profile. This experiment will also provide an understanding of the benefits associated with the IDSM measures installed on the RESU and CES Blocks.

Field Experiment 1B: Impact of Demand Response Events on Smart Devices, Homes, and Grid

The objective of this experiment is to quantify the impacts of DR¹² events on the load profiles of smart devices, the homes, and the secondary transformers. The following is a summary of ISGD's various components and types of load control tests.

¹² Demand Response signals use the ZigBee Smart Energy Profile 1.x protocol via the project smart meters.

Table 9: Demand Response Components

Device	Demand Response Mode	Price Signal
Programmable Communicating Thermostat	<ul style="list-style-type: none"> Degree offset Degree set point Duty cycle 	None
Smart Appliances (clothes washer, dishwasher and refrigerator)	<ul style="list-style-type: none"> Low power mode (all) Delayed start (clothes washer and dishwasher) 	None
In-home Display	None	Price displayed on screen
Residential Energy Storage Unit	<ul style="list-style-type: none"> Calculated discharge 	None

SCE plans to perform these experiments multiple times in order to evaluate performance under a variety of conditions, and to verify the consistency of results in terms of demand reduction. The team will likely perform these tests during summer months when the weather is warmer and the potential for load reduction is greater. The peak load reductions will be determined by comparing customer load profiles on experiment days with customer load profiles on non-experiment days, simulation results, and control home load profiles. The team will also observe the load pattern of the specific devices included within the test to determine their load reductions during the test event.

Field Experiment 1C: RESU Peak Load Shaving

The objective of this experiment is to quantify the ability of the RESU to shift coincident peak load to the off-peak period by discharging during the peak period. The team will place a group of RESUs (e.g., a block, the entire group of project homes, or another subset) into an operating mode (either a time or price-based mode) that schedules the RESUs to discharge during the peak period. Locally installed power meters and the customer's smart meter will record data throughout a test period of at least one week. The team will capture data to validate that the RESU appropriately charges and discharges to reduce the peak demand and energy consumption during peak hours. The team will evaluate the impact of the RESU using data from the control homes and the experiment homes for prior dates, over test periods of at least one week.

Field Experiment 1D: RESU Level Demand

The objective of this test is to quantify the ability of the RESU to automatically level demand over a 24-hour period. RESUs will operate in the Level Demand mode, which directs the RESU to discharge during periods of high demand and charge during periods with little load, thereby flattening the home's demand curve. The team will compare the customers' smart meter data with baseline data (loads without battery power) to ensure that the mode minimizes the customers' peak demand.

Field Experiment 1E: CES Permanent Load Shifting

The objective of this experiment is to quantify the CES's ability to shave demand on the secondary transformer. The CES will automatically adjust its discharge power level based on real-time load provided from a locally installed power quality meter. This control will reduce the demand on the transformer. The team will analyze data collected from the power quality meter on the transformer to verify that the CES system reduces peak demand, and to investigate other impacts of this peak reduction (such as transformer temperature).

Field Experiment 1F: Impact of Solar PV on the Grid

The objective of this experiment is to quantify the impacts of rooftop solar PV generation on the load profile of the secondary transformer. This is a data collection activity only. Power quality meters installed on the local transformers will record transformer duty cycles (including load and temperature profiles). The team will compare this data to baseline duty cycles to analyze the impact the solar PV generation has on the transformer.

Field Experiment 1G: EVSE Demand Response Applications

The objective of this experiment is to demonstrate the utility’s ability to modify PEV charging behavior by communicating demand response event signals to a PEV’s EVSE. This experiment will test charging curtailment (i.e., reducing charging to 0 kW), as well as “throttling” whereby charging is reduced in 5% increments.

Field Experiment 1H: EVSE Sub-metering

The objective of this effort is to demonstrate the utility’s ability to generate and transmit PEV-specific energy consumption data to the utility back office using both an EVSE integrated device and a utility owned device. As a stretch goal, the team will demonstrate how to reconcile whole-house energy consumption with PEV charging consumption data in the back office, a potential PEV billing method referred to as *subtractive billing*. This is a proof-of-concept demonstration of a PEV metering capability rather than an experiment.

3.1.2 Sub-project 2: Solar Car Shade

If plug-in electric vehicles achieve widespread adoption, it is likely that drivers will want to charge at work during the day to reduce “range anxiety,” a driver’s concern that a PEV would run out of energy before reaching their destination. However, daytime car charging will increase electricity demand during the day, and it may increase local or system peak demand. This sub-project is demonstrating a PEV charging system designed to minimize the net consumption of energy from the grid due to PEV charging. The team expects the system to reduce or eliminate the impact of PEV charging during on-peak periods.

Figure 3: Workplace Electric Vehicle Chargers and Solar PV Structure



3.1.2.1 Objective

The objective of this sub-project is to demonstrate how distributed solar PV generation, battery energy storage, and smart charging capabilities can help minimize the grid impact of PEV charging during peak periods.

3.1.2.2 Approach

The team installed solar panels above a parking garage on the UCI campus. The installation includes a 48 kW solar PV array that generates renewable energy during daylight hours and 20 parking spaces with EVSEs for PEV charging. SunPower supplied the solar PV array and BTC Power supplied the EVSEs. Anyone that has a UCI parking permit can charge a PEV in one of these spaces. Each EVSE is capable of receiving demand response messages and sending relevant energy consumption data to the manufacturer’s back-office systems. Each EVSE has a maximum rating of 6.6 kW. The solar PV array receives support from a stationary BESS sized for 100 kW of power output and 100 kWh of energy storage. The energy storage system supports PEV charging during on-peak periods and cloudy

days, and charges itself from the solar PV array and/or off-peak grid energy. Princeton Power Systems supplied the BESS.

3.1.2.3 Research Plan

3.1.2.3.1 Laboratory Tests

The team performed laboratory testing to simulate all BESS field tests in a controlled environment to ensure proper functionality and to prepare for the field tests. This testing helped the team determine whether the hardware and software operate according to the project's specifications. Testing helped to ensure that remote commands could control the system. The team also performed integrated system testing with a PV simulator to evaluate the PV functions.

3.1.2.3.2 Commissioning Tests

To commission the EVSEs and BESS, the team performed a series of tests in the field to verify that these components can perform their required functions.

- **EVSE remote load control:** The intent of this test was to verify that the EVSEs are capable of responding to remote load control signals to modify their charging behavior.
- **Remote battery dispatch:** The intent of this test was to verify that the BESS is capable of responding to a DR event signal. Power meters that record demand at the point of common coupling between the solar car charging system and the UCI grid were analyzed to ensure the BESS dispatched energy as requested and returned to its previous operation afterward.

3.1.2.3.3 Field Experiments

The ISGD team is performing the following experiments to evaluate the impacts of the sub-project 2 capabilities.

Field Experiment 2A: Minimize Peak Period Impact of PEV Charging

The objective of this test is to quantify the impact to the grid of charging electric vehicles using a charging system supported by solar PV and energy storage. The team performs this experiment by placing the BESS in a mode that minimizes the grid impact of electric vehicle charging. This mode attempts to reduce demand from the charging system to zero during peak periods. Local power meters record EVSE loads, solar PV generation, battery usage, and net demand. The team uses this data to analyze the behavior of the BESS and to verify its ability to minimize the impact of the PEV charging during peak periods.

Field Experiment 2B: Cap Demand of PEV Charging System

The objective of this test is to quantify the BESS's ability to limit demand of the PEV charging system at the interface with the electric grid. The team conducts this experiment by placing the BESS in a mode that limits demand to a specified threshold throughout the test period (24 hours a day) whereby it discharges whenever the load exceeds this setting. Power meters record EVSE loads, solar PV generation, battery usage, and net power. The team uses this data to analyze the behavior of the BESS and to verify that demand does not exceed the requested level.

Field Experiment 2C: BESS Load Shifting

The objective of this test is to quantify the impact of the PEV charging system while the BESS performs load shifting. The team performs this experiment by remotely configuring the BESS to shift load by charging during off peak periods and discharging during peak periods. Local power meters will record EVSE loads, solar PV generation, battery usage, and net power. The team uses this data to analyze the behavior of the BESS and to assess the PEV charging system's impact on the grid.

3.2 Next-Generation Distribution System

The electric grid is evolving into an increasingly dynamic system with new types of distributed and variable generation resources and changing customer demands. ISGD is evaluating technologies designed to support grid efficiency and resiliency within this changing environment. The team is evaluating these technologies in four sub-projects: sub-project 3: Distribution Circuit Constraint Management Using Energy Storage, sub-project 4: Distribution Volt/VAR Control, sub-project 5: Self-healing Distribution Circuits, and sub-project 6: Deep Grid Situational Awareness.

3.2.1 Sub-project 3: Distribution Circuit Constraint Management Using Energy Storage

3.2.1.1 Objectives

The objective of this sub-project is to demonstrate the use of battery energy storage to help prevent a distribution circuit load from exceeding a set limit and to mitigate overheating of the substation getaway.

3.2.1.2 Approach

This sub-project is demonstrating a mobile, containerized DBESS connected to the Arnold 12 kV distribution circuit. This circuit receives power from MacArthur Substation and is the same circuit where the project test homes in sub-project 1 are located. The DBESS has a rating of 2 megawatt (MW) of real power and 500 kWh of energy storage. The system includes supporting equipment such as a thermal management system and an interconnection skid to the 12 kV distribution system. SCE personnel monitor and control the DBESS locally.

3.2.1.3 Research Plan

3.2.1.3.1 Laboratory Tests

The team tested battery controls and all auxiliary system components prior to field installation to verify performance and proper functionality. The team also performed integrated system testing in the lab setting. To ensure that each component performs as expected, the team evaluated and repeatedly exercised the energy storage component, the power conversion system, and the control system. The team conducted real and reactive power import and export testing at various levels and durations to measure the response speed and to verify the precision and stability of the output. The team measured and analyzed cell voltage, state of charge (SOC), cell temperature, and inverter temperature to determine the relationships among these parameters.

3.2.1.3.2 Commissioning Tests

Prior to regular operation of the DBESS in the field, the team plans to perform a series of tests to verify that the components can perform their required functions. The intent of these tests is to verify that the device can synchronize with the grid, and that the protection elements are set properly. The team also plans to demonstrate SCE's ability to control the DBESS to inject or absorb power on the Arnold circuit.

3.2.1.3.3 Field Experiments

The ISGD team will perform the following experiment to evaluate the impacts of the sub-project 3 capabilities.

Field Experiment 3A: Peak Load Shaving/Feeder Relief

This experiment demonstrates the DBESS's ability to prevent the circuit load from exceeding a set limit and mitigate overheating of the substation getaways. This experiment is conducted by injecting or absorbing real power (up to +/- 2 MW) to keep the circuit load from exceeding a set limit. The storage device charges when

conditions permit. The team records and analyzes circuit load, circuit voltage, battery SOC, and system power input/output to determine if the system is capable of performing the peak load shaving/feeder relief function.

3.2.2 Sub-project 4: Distribution Volt/VAR Control

This sub-project is demonstrating the use of DVVC to optimize customer voltage profiles. Delivering energy with customer voltage in the lower half of the American National Standards Institute (ANSI) C84.1 range can result in energy savings known as conservation voltage reduction (CVR). Many devices that use electricity operate satisfactorily at the lower end of their voltage range while also tolerating higher voltage. As a result, reducing customer voltage can yield energy savings while not compromising service. Energy savings as a function of reduced voltage vary by equipment type and by loading.

Lightly loaded induction motors are particularly significant in this regard. At higher voltages, such a motor draws more magnetizing current than needed, resulting in additional losses. When the same motor is heavily loaded, it may require higher voltage for adequate torque. Many electrical loads involve lightly loaded induction motors. Reducing the voltage supplied to these motors may therefore result in energy savings without any loss in motor function.

A distribution circuit may supply over a thousand individual customers with a mix of residential, commercial, and industrial users. The connected loads will likewise be a mix of motors, lighting, heating, electronic, and other types of loads. The effectiveness of CVR will depend on the mix of loads on a particular circuit and their responses to changing voltage.

Previous work at SCE under the Distribution Capacitor Automation Project (DCAP) program (described below) measured CVR at two distribution substations (Walnut Substation and Villa Park Substation) with a total of eighteen 12 kV distribution circuits and 72 switched capacitor banks (68 field capacitor banks and four substation capacitor banks). The results indicated that a 1% voltage reduction produced about a 1% energy savings. This ratio, which measures the decrease in power associated with a 1% voltage decrease (% power reduction/1% voltage reduction) is often called the CVR factor. In March 2012, EPRI released the results of a survey of 52 utilities, which reported measured CVR factors ranging from 0.4 to 1.0. The team will review available data to determine whether DVVC achieves the expected savings and whether the assumed CVR factor of 1 is still justified.

SCE currently uses technology that was developed many years ago to maintain customer voltage within its required voltage range, as designated in the ANSI C84.1 standard and modified by California Rule 2 (114 to 120 volts at the residential customer service connection). SCE uses load tap changer (LTC) transformers and capacitors to regulate system voltage and VARs, depending on the grid voltage level. LTC transformers typically control sub-transmission system voltage. These devices reside between the bulk power system (500 kV – 220 kV) and the sub-transmission system (115 kV – 66 kV). SCE's 12 kV and 16 kV distribution systems that are supplied by a 66 kV sub-transmission system, such as the ISGD system, use switched capacitors located along the circuits and within each substation connected at the distribution bus. Nearly all of these capacitor controls operate based on the locally sensed primary circuit voltage at its connection point. Each capacitor controller has a control bandwidth that switches a capacitor off when the primary voltage exceeds the upper band limit and switches the capacitor back on when primary voltage drops below the lower band limit.

To compensate for additional voltage drop during peak conditions in the secondary system (e.g., 120/240 volt) many of SCE's capacitor controllers use time bias and/or temperature bias. The bias will raise (or lower) the entire bandwidth during specific times of the day or temperature conditions as a means to provide additional voltage support during peak conditions. The problem is that this bias attempts to estimate (and compensate for) secondary voltage drop based solely on time of day and/or temperature. It does not sense load or customer voltage directly. While this system has provided adequate customer voltage control, it does not allow for optimal control that might be obtained by actively coordinating capacitor switching in a system.

SCE demonstrated CVR and a superior method of coordinated central capacitor control in a project called DCAP. From 1992 through 1994, SCE demonstrated DCAP at two distribution substations with a total of eighteen 12 kV distribution circuits and 72 switched capacitor banks. The scheme centralized the switching of field and substation capacitors to achieve the lowest average customer voltages possible without violating minimum voltage requirements at any measured point and without violating substation power factor limits. The system relied on special purpose secondary voltage monitors, which provided a direct measurement of customer voltage via radio. The team turned the DCAP system on and off for alternate time-periods and observed a CVR factor of approximately 1.0.

The ISGD DVVC capability is based on the approach previously used in DCAP. Like DCAP, the heart of this algorithm is a Voltage Rise Table (VRT), which tabulates the expected increase in voltage for each capacitor location when a given capacitor is switched on. This allows the system to take a given voltage snapshot of the system and consider the effect of all possible capacitor switching combinations on voltage at every measured point. DVVC selects the combination which results in the lowest average voltage without violating any constraints—substation power factor, excess switching, minimum and maximum voltages at any point. The process repeats at preset intervals or whenever any voltage measurement is outside an expected range.

DVVC uses primary voltages measured by capacitor controllers rather than secondary (customer) voltages as the feedback (controlled) parameter. The team made this choice because special purpose secondary voltage monitors (such as the ones used in DCAP) are too expensive and Advanced Metering Infrastructure (AMI) meter voltage information is not available on a real-time basis. As a result, unlike DCAP, DVVC does not directly measure customer voltage, which is the ultimate target of CVR. DVVC must allow for the voltage drop between the measured primary voltage and the customer voltage. DVVC accomplishes this by targeting a minimum primary voltage with an offset two to four volts higher than the minimum required at the customer meter. This offset should vary based on load conditions on the secondary. Since DVVC does not directly measure secondary load, it uses substation transformer load as a proxy. Substation load is simply the sum of all the secondary loads, so this should be an effective proxy. **Table 10** shows the primary voltage control range as a function of substation transformer loading used by DVVC. The lower voltage limits are intended to maintain customer voltages at no lower than 114 volts on a 120 volt nominal basis. This is achieved by keeping primary voltage progressively higher as load increases.

Table 10: Primary Voltage Control Ranges

Transformer Loading Levels	Minimum Voltage – Maximum Voltage
≥ 100%	118 – 124
80% ≤ --- < 100%	117 – 122
< 80%	116- 120

Even though AMI meter voltage information is not available in real time, it is available for download and engineering analysis. The team is retrieving and using this AMI data to verify the DVVC’s overall effectiveness.

The ISGD project will also demonstrate an integrated volt/VAR control (IVVC) capability, which uses power flow calculations rather than a voltage rise table as its principle of operation. This means that it will run full load flow calculations for each possible capacitor combination to determine the resultant system voltages. The Final Technical Report will provide additional details about IVVC. The team plans to test this system after the DVVC testing is complete and to compare the relative performance of both approaches to volt/VAR optimization (VVO).

3.2.2.1 Objectives

The objective of sub-project 4 is to test both the DVVC and IVVC as advanced methods of distribution system volt/VAR control against the legacy method. The team will compare the performance of each system to better inform future deployment of VVO schemes system wide.

3.2.2.2 Approach

SCE is building on its experience with DCAP to incorporate advanced volt/VAR control in the ISGD project. The ISGD team used circuit load flow models to determine voltage rise as a function of capacitor switching in order to populate the VRT. The team modeled the capacitor switching-decision algorithm using Excel.

The ISGD DMS hosts the DVVC algorithm. The ISGD DMS communicates with the production DMS and uses its services to establish communication with field components such as circuit capacitors using Netcomm radios. The ISGD DMS communicates with substation elements via the production DMS's link to the Energy Management System (EMS) and its SCADA system. The ISGD DMS can also communicate with substation elements directly via the substation gateway. System operators retain the ability to disable this ISGD DMS link and regain normal control at any time. The ISGD DMS, production DMS, and EMS all run on the GE XA/21 system.

The approach to deploying and testing the DVVC (and later the IVVC) involved concept validation through simulation, integration laboratory testing on the ISGD DMS at both the factory and the site, commissioning on the ISGD-DMS, and field experiments.

3.2.2.3 Research Plan

3.2.2.3.1 Simulations

The team modelled the substation operating bus and its seven circuits, including the ISGD circuits (Arnold and Rommel), using the Positive Sequence Load Flow (PSLF) program. Capacitor switching recommendations from the Excel version of DVVC were applied to this model. The team simulated a representative set of loading scenarios. The system model responded to these capacitor-switching recommendations as expected.

3.2.2.3.2 Laboratory Tests

The team evaluated the field apparatus and systems comprising the DVVC at SCE's Advanced Technology Labs to determine whether the DVVC system is capable of meeting voltage requirements and to assess system performance. Technology component testing occurred before field installation to verify performance and proper functionality. The team also performed integrated system testing in the lab setting. During the second year of the demonstration period, the project will transition to the IVVC method, which utilizes real-time load flow information to manage the capacitor bank operations.

3.2.2.3.3 Field Experiments

The ISGD team is performing the following experiments to evaluate the impacts of the sub-project 4 capabilities.

Field Experiment 4A: DVVC VAR Support

This experiment uses the DVVC application to supply additional VAR support to the transmission system. The team demonstrates this capability by verifying that the transmission system receives additional VAR support upon raising the customer target voltage to the highest allowable level (without exceeding upper regulatory limits). SCE Operations would make the emergency request in real life, but the ISGD team is simulating this request for the ISGD project. Test protocols and data collected from substation relays and customer meters are used to measure the DVVC impacts.

Field Experiment 4B: DVVC Conservation Voltage Reduction

This experiment consists of operating the DVVC algorithm to determine if it satisfies DVVC's main objectives. These objectives include meeting substation VAR requirements (when possible), minimizing average customer voltage, and minimizing capacitor controller switching. DVVC is turned on and off on alternate weeks. When DVVC is turned on, the field capacitors are set to wider "backup" on and off voltage settings. When it is turned off, the field capacitors are reset to normal control values. In this way, the team can perform a valid comparison between voltage behavior with and without DVVC.

3.2.3 Sub-project 5: Self-healing Distribution Circuits

This sub-project will demonstrate a self-healing, looped distribution circuit that uses low-latency radio communications to locate and isolate a fault on a specific circuit segment, and then restore service once the fault clears. This protection scheme isolates the faulted circuit section before the substation breaker opens. This functionality should lead to improved distribution circuit reliability by reducing the number of customers exposed to momentary outages and easing the circuit restoration burden on system operators and equipment.

3.2.3.1 Objectives

The objective of this sub-project is to demonstrate an advanced circuit protection capability that reduces the number of customers impacted by outages, and reduces the service restoration time for customers impacted by outages.

3.2.3.2 Approach

When a fault occurs on a standard radial distribution circuit, a circuit breaker opens, which causes the entire circuit to lose power, affecting all customers served by that circuit. While automated switching can sometimes restore part of the circuit within a few minutes, all customers experience at least a short outage. This can negatively affect reliability statistics and extend outage restoration times for radial circuits.

ISGD's self-healing distribution circuit includes a looped topography, four URCLs,¹³ and low-latency, high-speed radio communications between individual URCLs and the substation protection relays via a substation gateway. This communication system allows the URCLs and the substation protection relays to collaborate by isolating and managing faults that occur on two circuits fed by the substation. Quickly isolating a smaller circuit segment during fault events (before the substation breaker opens) can reduce the extent and duration of distribution outages, thereby improving electricity service reliability. A secondary benefit of this sub-project is demonstrating radio as a low cost alternative to fiber optic communications. This is a more cost-effective way to perform retrofits on existing substations and circuits.

This sub-project is using two 12 kV distribution circuits (Rommel and Arnold) out of Macarthur Substation to form a single looped circuit. Each of these circuits includes two URCLs. The URCLs communicate with each other and the substation feeder relays using standard IEC (International Electrotechnical Commission) 61850¹⁴ Generic Object Oriented Substation Event (GOOSE) messaging for protection coordination. This protocol supports the high-speed messaging required for this protection scheme. Since the purpose of this distribution protection system is to only interrupt the faulted section of a circuit, the protection communications and control operations need to operate

¹³ Each URCL contains four key hardware components: G&W Viper-S Padmount Recloser, SEL 651R Recloser Controller, S&C Electric Intellicom Radio, and an Elastimold Control Power Transformer. These components provide power monitoring, device control, communications, and fault interruption.

¹⁴ The IEC 61850 standard provides an internationally recognized method of communications for substation circuit protection, monitoring, control, and substation metering. The standard was specifically designed to provide a utility standard for object-oriented development, resulting in simplified system configuration and integration, and increased processing speeds.

faster than the substation circuit breaker. Substation circuit breakers currently operate within 500 to 600 milliseconds (ms) of a fault event. If the URClS take longer to isolate a fault, the substation circuit breaker will open, causing the entire circuit to lose power.

Figure 4 depicts the timeline of a hypothetical fault on a distribution circuit, including the time required to clear the fault.

Figure 4: Distribution System Protection Event Sequence and Timeline

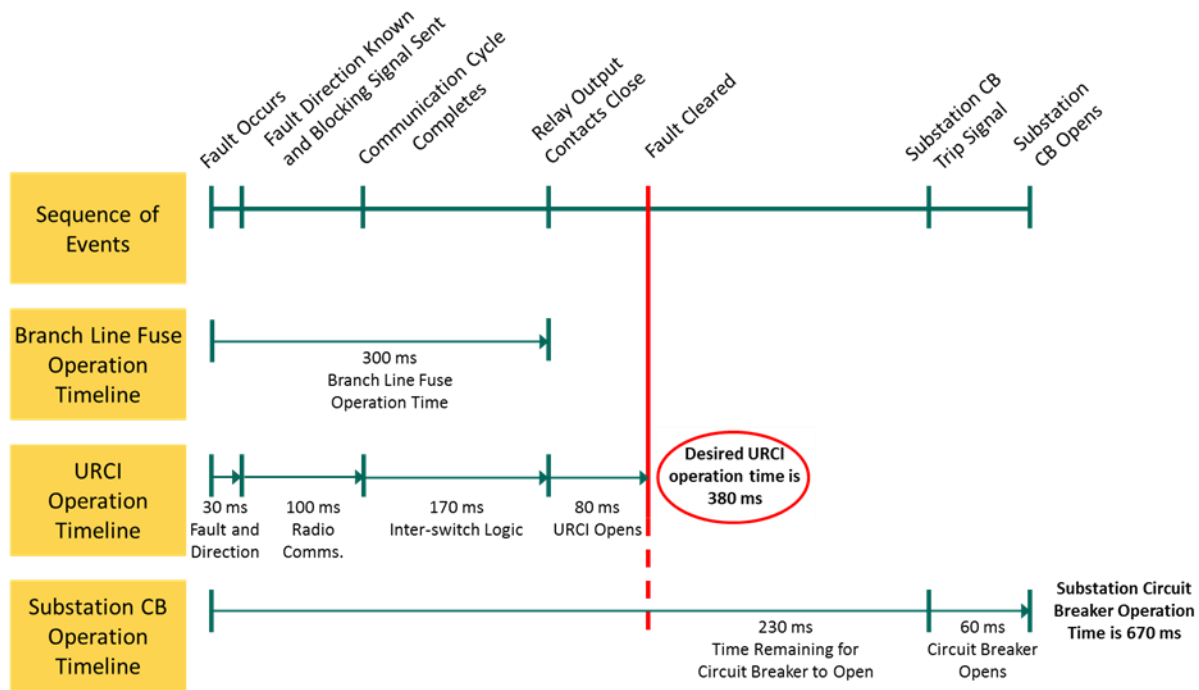

Detecting the fault and determining its direction requires approximately 30 ms. The time required may be longer, depending upon the time/overcurrent curve in operation and the fault magnitude. An additional 100 ms is required for the radio communications to send the blocking signals between the URCl relays, and an additional 170 ms is needed for communications retries and execution of the logic within each URCl relay. This equates to 300 ms, the same amount of time allowed for circuit branch line fuses to operate for a high-current fault. Branch line fuses limit outages to branches lines, which are smaller than segments that the URClS are designed to isolate. Thus, the URCl logic intentionally waits 300 ms to allow the branch fuses to operate.

Once the URCl logic is complete, the URCl relays send signals to open the vacuum interrupters—this only applies to the two relevant URClS involved in isolating the fault. The interrupter needs approximately 80 ms to physically open. If the protection scheme operates correctly, the system would clear the fault within about 380 ms. If the protection scheme does not operate properly, the substation circuit breakers would be signaled to open and interrupt the fault within another 230 ms. The circuit breaker needs an additional 60 ms to physically open. In this case, the system would clear the fault within 670 ms.

This protection scheme necessitates communications fast enough to send and receive GOOSE messages within 100 ms. Since GOOSE messages are small, the communications system does not need to be broadband. However, it must be low-latency. The radio system also requires sufficient propagation to minimize the need for repeater radios, since these radios increase latency. ISGD is using a system that operates in the 2.4 gigahertz (GHz) unlicensed spread-spectrum band, which requires several repeater radios to cover the area where the URClS are located. A 900-megahertz (MHz) system that met the team’s latency requirements was not available.

Since the URClS are supposed to be universal, the logic is the same for all four URClS. When a fault occurs, each URClS needs to determine whether the fault is either “upstream” or “downstream” from it. The team accomplishes this by properly setting the polarity of the connections to the current transformers at each location. Each URClS must also be able to communicate with the adjacent URClS. The team accomplishes this by configuring each URClS to “subscribe” to messages from the neighboring URClS.

During an actual fault event, once the URClS determine the fault location and direction, the relevant URClS send trip or block-trip messages to the neighboring URClS using the IEC 61850 GOOSE messaging protocol. The URClS use internal logic to identify a fault and its direction. The URClS sense both phase and neutral time-overcurrent and determines which neighboring URClS to send the GOOSE blocking message. When a URClS receives a blocking message, it stops the circuit breaker from opening. The URClS maintains this block as long as the blocking message is from an adjacent relay. When the time-overcurrent element of any unblocked relay times out (one on each side of the fault), its vacuum interrupter opens. Because of different impedances for each of the two ways the current can flow around the circuit loop, the current feeding the fault will differ for each URClS. The direction with the higher current will trip its interrupter more quickly. To ensure that the URClS on the other side of the fault trips quickly and speeds fault isolation, the tripped URClS sends a signal to the URClS on the other side of the fault instructing it to open its interrupter.

3.2.3.3 Research Plan

3.2.3.3.1 Simulations

The team has conducted simulations to verify the fault isolation logic, timing, and successful tripping of URClS devices under a wide range of operating conditions, including failure of equipment (N-1) configurations. The team used RTDS to conduct these simulations. The actual protective relay inputs and outputs (three phase voltages and currents, trip contacts, close contacts, and breakers status input) interfaced with RTDS.

The team also plans to perform simulations using GE’s advanced DMS applications, Contingency Load Transfer (CLT), and Fault Detection, Isolation and Restoration (FDIR). The team will compare these simulation results to the simulation results using the URClS capability to determine the relative effectiveness of each for improving distribution system reliability.

3.2.3.3.2 Laboratory Tests

The team assembled and tested the technology components (e.g., relays and radios) before field installation to verify performance and proper functionality. The team imposed actual circuit fault conditions (derived from simulations) on the assembled components and recorded the protection system responses. The team also verified high-speed communication performance. This included assembling and testing the new substation automation system to verify the communications between the substation and the URClS.

The team did not induce actual faults on the live circuit given the presence of customers on the circuit. Lab testing served as a proxy for this type of field testing. However, the team installed instrumentation to record any actual faults that occur on the circuit. Actual faults will provide additional verification of the design and operation of this advanced protection system.

3.2.3.3.3 Commissioning Tests

Prior to commissioning the self-healing circuit capability, the team will verify the functionality of the system by validating the operation of the low-latency communication system and the URClS in a bypassed condition. These tests will be performed a number of times by simulating faults on each of the looped circuit segments. Since the URClS will operate in bypassed mode, there will be no service interruptions to SCE’s customers.

3.2.3.3.4 Field Experiments

The ISGD team will perform the following experiments to evaluate the impacts of the sub-project 5 capabilities.

Field Experiment 5A: Self-healing Circuit

Since the team will not impose any faults on Rommel or Arnold, it will only use actual fault events to evaluate the ability of these circuits to self-heal. In the event a fault does occur, the team will evaluate the enhanced fault protection and automated feeder switching functionality based on recorded substation and URCI fault event information.

Field Experiment 5B: De-looped Circuit

The team will also operate the circuits in a radial configuration to verify that the URCIs function properly using that configuration. The looped circuit may be de-looped to a radial configuration for test purposes, when high loads create circuit instability, or during other abnormal system conditions.

3.2.4 Sub-project 6: Deep Grid Situational Awareness

3.2.4.1 Objectives

The objective of this sub-project is to demonstrate how high-resolution power monitoring data captured at a transmission-level substation can detect changes in circuit load from a distributed energy resource (DER) such as demand response resources, energy storage, or renewables. This capability could help enable aggregators of such resources to participate in energy markets by providing a means of verifying resource performance. This capability would obviate the need for additional and potentially costly metrology equipment for each individual participating resource.

3.2.4.2 Approach

To fulfill this task, the team is using a 2 MW battery installed on a 12 kV distribution circuit to perturb the load signal intentionally by dispatching the battery at various ramp rates and magnitudes. Synchrophasor data acquired at the Santiago and MacArthur substations, which feed the 12 kV circuit, are then analyzed to see if the DER perturbation (battery dispatch signal) can be isolated from the rest of the circuit load data. The plan is to run simulations to find a threshold (size of the battery or signal amplitude and/or ramping rate magnitude) that can be detected successfully at Santiago Substation, a transmission-level substation and MacArthur Substation, a distribution-level substation. The installation of monitoring equipment at Santiago Substation is part of SCE's Phasor Monitoring and Grid Stability System previously approved by the California Public Utilities Commission. The MacArthur Substation relays are part of SCE's next generation of substation automation (SA-3) upgrade. These relays are equipped to provide high-speed data to a dedicated phasor data concentrator (PDC) at the MacArthur Substation.

The team reviewed several methods for phasor measurement data acquisition and analysis and identified an adaptive filter as a viable option for filtering the signal and removing noise. Noise, in general, is a corruption of the measurement that may be due to a number of phenomena including sensor inaccuracies, interference from other signals, and data processing errors. In this particular case, noise also includes any small magnitude and short duration distribution circuit-level load perturbations (e.g., switching large loads that are not the DER of interest on or off) that are not the large magnitude, longer duration perturbations that the algorithm is designed to detect. An adaptive filter approach is useful for sensing DER in the distribution system because it can adapt to variations that are typical on the circuit (e.g., diurnal load profiles that are characteristic but vary from day to day) so that data without DER dispatch can be retained and identified as "normal" (business as usual) circuit behavior.

The next step is to design an algorithm capable of forecasting the short-term filtered load signal when the DERs are not dispatched/charged. An artificial neural network (ANN) algorithm is appropriate for this purpose. An ANN

algorithm is a type of statistical learning algorithm that can estimate or approximate functions that can depend upon a large number of inputs and are generally unknown. This is the case, for example, in distribution circuits with a large number of unknown loads for which on/off dynamics cannot be predicted a priori. The ANN algorithm can compute expected near term future values from a statistical understanding of previous inputs, and is capable of learning how the circuit typically varies, recognizing typical patterns due to its adaptive nature.

To fully implement this algorithm, a large amount of data is required to train the algorithm. This data consists of phasor measurement data collected while the DER is not operating. During this second TPR period, the UCI team trained the algorithm with phasor measurement data covering one day from MacArthur Substation. The team is using this data to implement and train a preliminary ANN algorithm and to show how the algorithm would work.

The final step is to separate the battery signal from the filtered signal (without noise), in other words, to detect a change in the signal that is associated with the dispatch/charging of the battery. To accomplish this, the team will perform various tests to study the overall change in the signal collected by synchrophasor measurements under various dispatch and charging operations of the battery. The team has identified the tests that are required for this purpose and has built them into the test plan.

The overall approach is to 1) pass the load signal collected by synchrophasors through an adaptive filter to remove the noise in the signal, 2) use an ANN to forecast the signal, and finally, 3) determine if DER operation has occurred. If the collected signal is similar to the forecasted one, DER has not operated. If the actual and forecasted signals are significantly different, DER operation has occurred. Comparing the determinations made by this data analysis to the known operation of the 2 MW battery will allow the team to assess the algorithm's capabilities and limitations.

Theoretically, if the team performs these tests on other DERs and their impacts on the overall signal are known, the team could use this procedure to identify other types of DER dispatch as well. But for now, the team is designing the algorithm to be able to determine whether the change in the signal is due to the battery or not.

3.2.4.3 Research Plan

3.2.4.3.1 Field Experiments

The ISGD team will perform the following experiment to evaluate the impacts of the sub-project 6 capabilities.

Field Experiment 6A: Verification of Distributed Energy Resources

SCE will operate a 2 MW battery to produce load changes of various magnitudes and durations, and at various ramp rates. The magnitude of these changes will be up to 4 MW, spanning from a maximum charge rate of 2 MW to a maximum discharge rate of 2 MW. UCI will then analyze high-speed data from Santiago Substation and attempt to identify the specific load change resulting from operation of the 2 MW battery. The team will perform similar data collection and analysis at MacArthur Substation, where the overall load should be approximately one-tenth that of its parent, Santiago Substation. The team will compare the DER operation detected at each substation by the algorithm to the known charge and discharge operation of the battery to determine the viability and limitations of this method.

3.3 Interoperability & Cybersecurity

The electric grid is evolving to include an increasing number of distributed and interconnected grid resources, both utility and customer-owned. The need for plug-and-play interoperability within a secure environment is therefore of critical importance. This project domain is a foundational element that underpins the development of smart grid capabilities. ISGD is evaluating interoperability and cybersecurity through sub-project 7, which is composed of two elements: Secure Energy Network and Substation Automation 3.

3.3.1 Sub-project 7: Secure Energy Net

3.3.1.1 Objective

The objective of SENet is to implement a secure communications and computing architecture to enable the interoperability of all ISGD sub-projects throughout the project lifecycle.

3.3.1.2 Approach

Secure communications between smart grid devices, the utility, and customers is a basic requirement and fundamental enabler of smart grid functionalities. The smart grid requires information sharing between many utilities and system operators, across electric reliability regions, to support the U.S. energy policies described in the 2007 Energy Independence and Security Act, Title XIII. A secure telecommunications infrastructure linking regional transmission and utility operations across the U.S. and North America will provide the essential information technology backbone for a smart grid.

Information demands include not only those from the utility to support operations, but also from customers and third parties looking to support their own near real-time decision making needs such as DR.

Smart grid sensing and control devices require secure communications capabilities between utilities' central control centers and offices, across backbone networks out to the new in-substation networks, field area networks (FAN), and HANs. Finally, since the requirements for secure utility communications are emerging and evolving, a key challenge facing utilities is meeting these security requirements in a way that allows flexibility and avoids having to continually replace IT infrastructure.

The ISGD team has designed SENet to include five communications network domains. These communications networks support four groups of capabilities that SENet should enable. These communications networks and capability groups are described in additional detail below.

The ISGD team designed a secure telecommunications infrastructure linking the following five network domains:

1. Intra-utility Network: This network connects back-office data systems with grid control centers and to substation gateways. It also supports control, protection, and measurement functions using a high-speed fiber backbone leveraging MPLS (Multiprotocol Label Switching) routers.
2. Substation Local Area Network: This provides communications between devices within a substation that support control, protection, and measurement functions for distribution automation.
3. Field Area Network: This provides communications between a substation, circuit-connected devices, and HANs. This network supports wireless broadband, protection, and interfaces to the Intra-Utility network.
4. Internet and Public Carrier: This network will provide non-critical monitoring data such as energy related information exchange over secure connections. This network may use wireless carriers and commercial Internet providers.
5. Home Area Network: This network connects to customers' two-way devices to send, receive, and collect energy information. Gateways within the customer premises will provide connectivity to diverse networks.

To help satisfy the SENet objective of providing a secure communications and computing environment for ISGD, the team has implemented the following four capability groups.

1. Modern Infrastructure and Communications: Implement and test the viability, compatibility, and resiliency of next-generation networking protocols, and deploy grid control applications on modern, virtualized platforms, to enable faster detection and resolution of issues, while minimizing down time to business operations.

2. **High-Assurance Cybersecurity:** Implement advanced security across the various smart grid domain networks. ISGD has implemented SCE’s Common Cybersecurity Services (CCS) platform, which the team expects to be scalable for a mature smart grid environment.
3. **Standards-driven Interoperability (communications and interfaces):** Utilize standard system interfaces and communications protocols, where possible, to facilitate integration and interoperability between back-office systems and field components. ISGD has implemented a services oriented architecture using GE’s Smart Grid Software Services Infrastructure (SSI) as a services integrator and broker, enabling interoperability across multiple vendors’ software applications.
4. **Visualization:** Enhance situational awareness by facilitating real-time decision making as well as after-the-fact investigation of catastrophic events by co-relating data elements from a disparate set of data sources, both historical and real-time, to serve a unified view to grid operations.

3.3.1.3 Design

ISGD used a structured systems engineering process that began with developing a logical architecture of system services. The team then decomposed service domains into lower level service components to develop system specifications and interfaces. Each new level of decomposition inherited the requirements of the higher-level service (within the logical structure), resulting in clear traceability and interoperability across components with shared services. **Figure 5** shows the grouping of functional services into seven domains, each representing different logical processing environments.

Figure 5: ISGD Services Domains

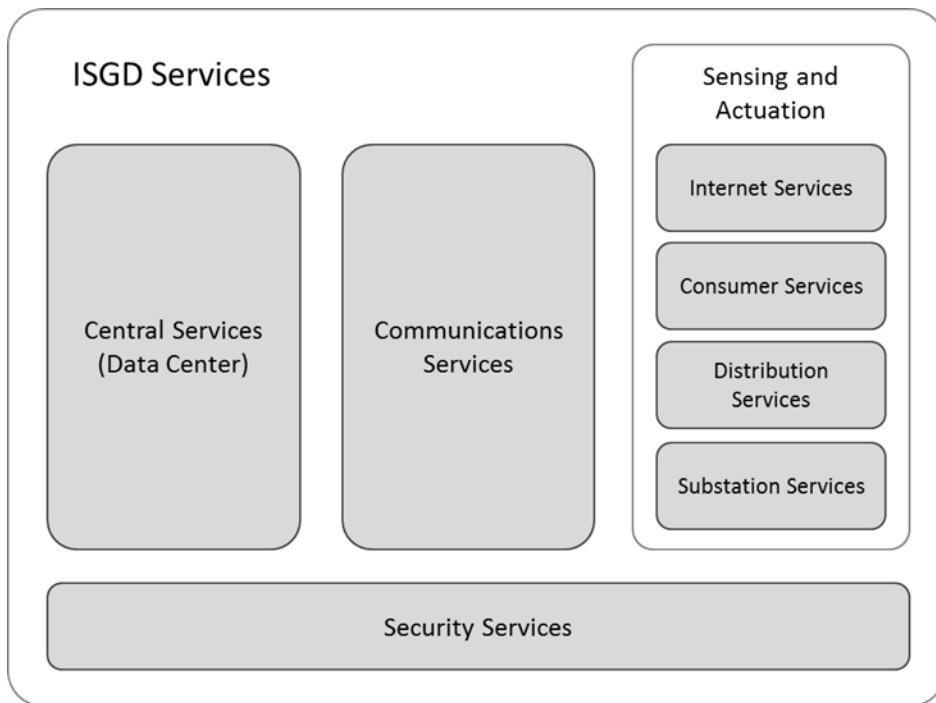

Security is a foundational service, which supports the other service domains. A general design principle was to share resources and services wherever possible, including the areas listed in **Table 11**.

Table 11: SENet Resources and Services Sharing

Functional Area	Technology Sharing or Reuse
Computing	<ul style="list-style-type: none"> • Server operating system virtualization (VMware)
Networking	<ul style="list-style-type: none"> • Packet switched networks (Internet protocols)

Functional Area	Technology Sharing or Reuse
	<ul style="list-style-type: none"> Multiprotocol label Switching (MPLS)
Storage	<ul style="list-style-type: none"> SAN (storage area network) Relational Database Management System Time-series data historian (point/time/value)
Integration	<ul style="list-style-type: none"> Web service application containers/platform Queuing

Figure 6 shows the second level decomposition of the ISGD logical system architecture.

Figure 6: ISGD Logical System Architecture

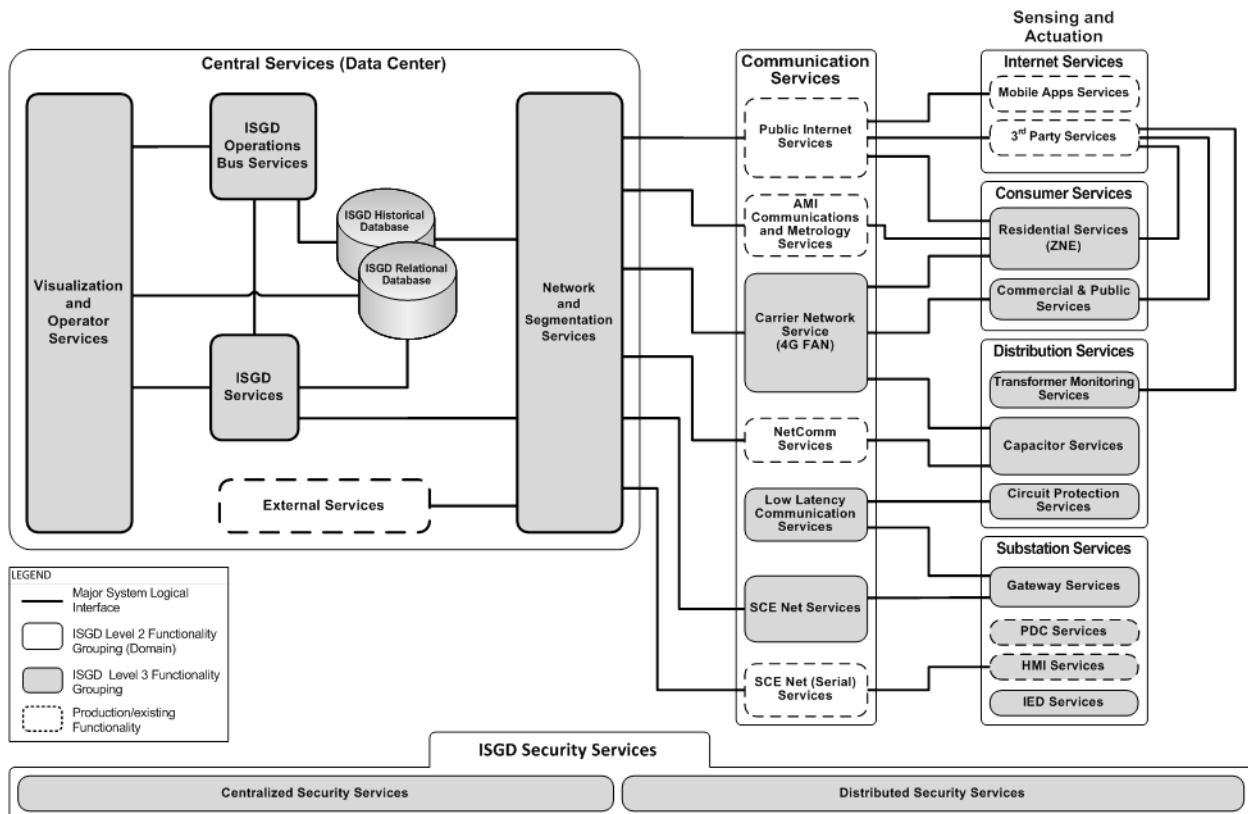

Decomposing the ISGD services domains into more discrete services, defining their requirements, and preparing detailed designs for each component provided the basis for selecting systems, equipment, and applications. Designs were prepared for each component, including processing, storage, and communications.

The resulting ISGD physical architecture is complex, and includes over 100 applications and 50 integrations (i.e., information exchanges between components).

3.3.1.3.1 Interoperability

ISGD attempted to implement smart grid protocols and interfaces wherever possible to support interoperability and to help facilitate integration. The level of standards adoption was an important consideration when selecting products. **Table 12** lists the primary smart grid and other general-purpose standards specified and used by SENet.

Table 12: ISGD Use of Interoperability Standards

Standard	ISGD Use of Standard
IEC 61850	IEC 61850 is used for substation device configuration and communications. GOOSE messages are used for high-speed transfer of events between URCl and the substation gateway.
IEC CIM (61968/61970)	ISGD uses the Common Information Model for integrating data from measurement devices. Primarily, some of the schemas in the central database are CIM-based. In addition, a set of CIM-based views allows for reading retrieval from various systems in a consistent form.
ZigBee Smart Energy	The programmable communicating thermostats, plug-in electric vehicle chargers, and smart appliances receive demand response event signals to automatically reduce consumption during peak periods.
ICCP	The Inter-Control Center Communications Protocol (ICCP or IEC 60870-6/TASE.2) is used to exchange capacitor, transformer, and URCl data between the ISGD DMS and production systems.
DNP3	This protocol is used by the ISGD DMS for measurement and control data to and from capacitor bank controllers and the CES device and by the EMS substation SCADA system.
IEEE 802	This is used for wired (802.3) and wireless (802.11) networking in all ISGD communications links.
IETF Standards	Many internet protocols are specified by IETF RFCs (Internet Engineering Task Force Request for Comments). Such standards include IPv4, IPsec (Internet Protocol Security), HTTP, etc. These standards are used throughout ISGD for all IP-routable communications.
W3C-WS-* (or REST)	Use of HTTP, SOAP (Simple Object Access Protocol), and XML (Extensible Markup Language) for web services interface definitions, used in several exchanges between back-office servers, and with “cloud” services including On-Ramp, TrendPoint, ALCS, and SSI.
Smart Grid Software Services Infrastructure	Visualization, reporting, and analysis integration retrieves data using Structured Query Language (SQL).

Enterprise Service Bus Overview

An enterprise service bus (ESB) is a software architecture model used in corporate environments to integrate multiple disparate software applications and systems. The cost of this integration can be prohibitive when each application or system requires a separate and unique interface. An ESB addresses this problem by using a Common Information Model (CIM) to support standard interfaces such that each application can communicate with each other through the ESB, which acts as an interpreter. An ESB should enable easy integration and secure, standards-based interoperability of third-party products and legacy systems, providing an ecosystem for smart grid operations. The key benefits of an ESB include:

- Increases flexibility (easier to adapt to changing requirements)
- Moves from point-to-point solutions to enterprise deployments
- Emphasizes configuration while reducing integration coding
- Leverages legacy systems to participate in future architectures

As utilities consider incorporating an ESB into their smart grid roadmaps, they should evaluate the following priorities to determine whether an ESB architecture is appropriate.

- Distributing information across the utility enterprise (including the grid control center), quickly and easily
- Creating a unified architecture among multiple underlying platforms, software architectures and network protocols

- Providing flexibility to accommodate future smart grid applications (both planned and unforeseen)

The level of effort required to integrate the ESB with legacy systems can be significant. Once a utility invests in an ESB, it should ensure that it has both the in-house skills and third-party vendors mature enough to realize the full potential of an ESB. This recommendation is discussed in detail in 5.1.3.3.

Enterprise Service Bus Role within ISGD

SCE implemented GE’s SSI as an ESB for ISGD. SSI supports high-speed command and control of a fully integrated smart grid with interoperability and cybersecurity. SSI is based on a service provider framework that enables modular applications to “plug in” to the infrastructure using well-defined, IEC CIM-driven services (such as IEC 61850, IEC 61968, IEC 61970, etc.). Adapters were developed and implemented to interface with legacy systems that do not conform to standard service definitions. These adapters were available as standard adapters from SSI, or were developed by GE or SCE. SCE is demonstrating the following services using SSI:

- Advanced metering infrastructure
- Transformer monitoring
- Home area network access via Internet
- Advanced load control
- Power outage/restoration messaging
- Distribution automation

ISGD’s SENet architecture is comprised of both new and legacy devices and information systems. The legacy systems may use a variety of standards and protocols as well as proprietary technologies. The SSI adapters enable interoperability among these devices and systems. The adapters translate communications protocols as well as data formats between systems, regardless of which hardware platforms and operating systems they run on. In addition, the SSI adapters, in conjunction with SCE’s Common Cybersecurity Services, enforce the correct level of security to the connected systems at the point these systems interface with SENet.

ISGD’s SSI implementation centered on creating a data store called the ISGD central database. This store serves as the basis for applications to exchange data. The team uses SSI as an execution platform in which applications retrieve and store data in the database. Storing data in the database was an integration approach, but it also supports ISGD’s advanced visualization capabilities. SSI is used to access various services, retrieve data, and serve the data to a situational intelligence visualization service. This service provides a single operational view from multiple systems, allowing the team to visualize grid conditions using multiple data sources. This constitutes a lesson learned, which is discussed in detail in chapter 5.

The SSI integration toolset integrates devices, applications, services and processes, which supports interoperability and secure communications across ISGD. SSI incorporates the emerging National Institute of Standards and Technology (NIST) smart grid standards across ISGD, while providing the flexibility to upgrade, extend, and scale the solution in the future so that the system can evolve as standards and technology evolves. The translation of communication protocols and data formats from legacy systems to SSI interfaces demonstrates an incremental migration path that will allow the systems to mature and evolve, while also accommodating new system components to interact. It is likely that adapters will be developed for the most common standards, and that these will be reusable across the industry.

3.3.1.3.2 Cybersecurity

As is the case in many industries, the cybersecurity landscape for utilities is changing rapidly. Increased use of automation, and the communications that support it, brings a new class of adversary and more malicious threats. A cybersecurity solution is needed that will keep pace with the latest technologies, supporting current and future as well as legacy systems and devices. It must support all application architectures, comply with all relevant standards and regulations, and enable operational efficiency through reuse.

SCE recognizes that redundant services (such as databases and web services) have the potential to create incompatibilities and duplicative expense. SCE has defined security as a common service, and has implemented it using a common platform for most ISGD applications. The solution has met all project objectives, and SCE is implementing more widely within the enterprise for additional locations and functions.

ISGD's security services are provided by SCE's Common Cybersecurity Services platform. CCS is a specification developed by SCE following cybersecurity guidance from NIST, NERC, DHS, and FIPS. All of the underlying protocols are public specifications from IETF and other standards bodies. The list below provides a brief overview of some of the standards used.

- Public key infrastructure (PKI) – Security certificate management
 - Simple Certificate Enrollment Protocol (SCEP) – Certificate issuance, revocation
- Network Configuration Protocol (NETCONF) – Network interface configuration management
- Internet Protocol security (IPsec) – Secure communications path establishment
 - Internet Key Exchange (IKEv2) – Mutual authentication and security associations
 - Encapsulating Security Payload (ESP) – Header encapsulation for security functions

IPsec is used to create virtual private network (VPN) tunnels with session encryption keys, through which all application communications are transmitted. Since these keys change rapidly, even if a session key is obtained using brute force, only the communications sent in that session could be decrypted, and it would take a long time to obtain it due to the key size, so the information would be quite old. Each end node is given a unique identity certificate, so that network traffic can originate in the field or in the back office, and still provide the following protections.

- Confidentiality – Network communications are encrypted with strong cryptography
- Data Integrity – Changes to communications are detected and quarantined
- Authentication – Communications from untrusted sources are rejected
- Access Control – Authenticated identities can be used to determine permissions

Figure 7 provides an overview of ISGD’s system security architecture. This figure includes a number of abbreviations that are defined in Appendix 1.

Figure 7: ISGD System Security Architecture

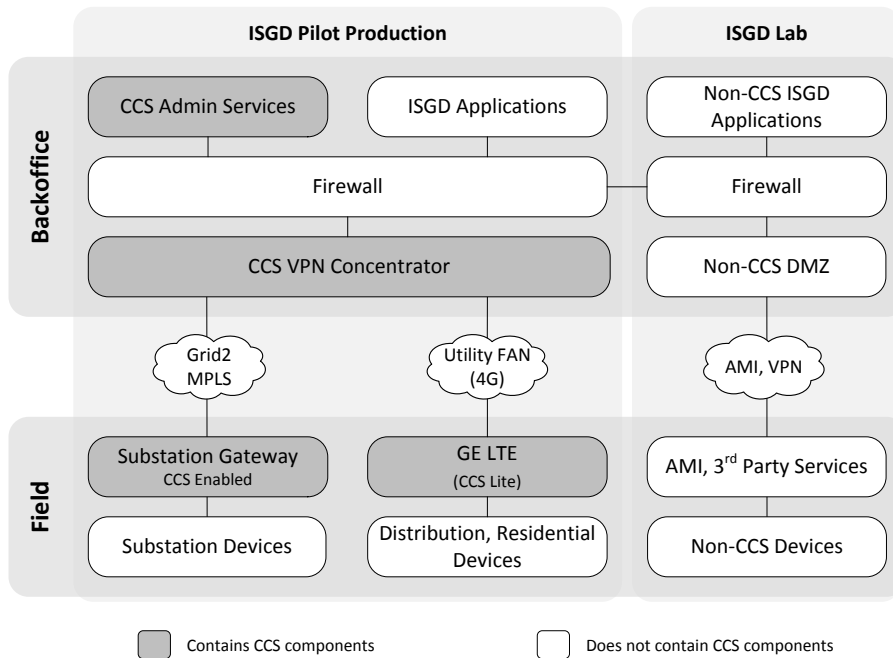

The system security architecture diagram shows that network communications between devices in the field and servers in the back office using the Grid2 and Utility FAN networks are protected by CCS. The communications are encrypted by the connected CCS endpoint (either VPN Concentrator, substation gateway, or GE LTE), transmitted across the network, and then decrypted by the CCS endpoint on the other side. The system supports MPLS, which allows for expedited routing through the network. Communications outside of the VPNC tunnels are protected by other electronic and/or physical security.

Applications that provide their own network services make it more difficult to use CCS. For these applications, OnRamp Transformer monitoring and the AMI system for ISGD, the native security implemented by the application system is used instead of CCS, and they are also guarded by a DMZ. The DMZ (demilitarized zone / perimeter network) guards internal networks and services from intrusions by external entities.

Centralized control of back office and edge device security is one of the key features of CCS. Through a central management console, operators can see all managed devices along with their quality of trust, providing awareness of and allowing response to cyber-attacks. **Figure 8** shows a view of the central management console.

Figure 8: Common Cybersecurity Services Management Console



Administrative operations, such as changes to credentials, network routing, or other network configurations, are carried out using a control plane separate from the data plane, with separate credentials and security. These can be thought of as separate channels within the network infrastructure. This separation allows for centralized recovery and control of credentials and configurations, even in the case of compromised devices. For example, if the configuration of a device is changed without authority, it is no longer trusted until it can be updated to an authorized configuration. The quality of trust of each communication link and device are tracked and managed centrally, providing the information needed in order to isolate and defend against attacks.

Additional aspects of the ISGD security solution include the following:

- No shared accounts or passwords are allowed
- Each user session requires authentication (proof of identity, via password and/or additional factors)
- Passwords must change periodically and meet minimum complexity requirements
- All unnecessary services are turned off, such as communications ports for unused remote access methods
- All communications take place over secured channels; all other channels are blocked
- Communications traffic is denied by default, and only allowed if it is specifically enabled
- Default accounts are removed or changed so that no simple or shared passwords exist
- Access to devices via external interfaces is explicitly controlled using CCS-provided, device-specific certificates, unique IDs, connection configuration files, and firewall rules
- Industry standards are used to harden client and server operating systems to prevent “back door” access and changes to installed software

3.3.1.3.3 Visualization

Most ISGD applications (e.g. ALCS, AMI, CES, RESU, BESS, and TrendPoint) have graphical user interfaces containing views of system measurement trends, system data, and configuration. The ISGD team also implemented a visualization application that provides integrated views of the various ISGD components in operation. ISGD is using this application for demonstration purposes only. Although it would be possible to build controls into this environment, ISGD is only using it as a situational awareness tool. **Figure 9** provides a sample screen view from the visualization application.

Figure 9: ISGD Visualization System Sample View

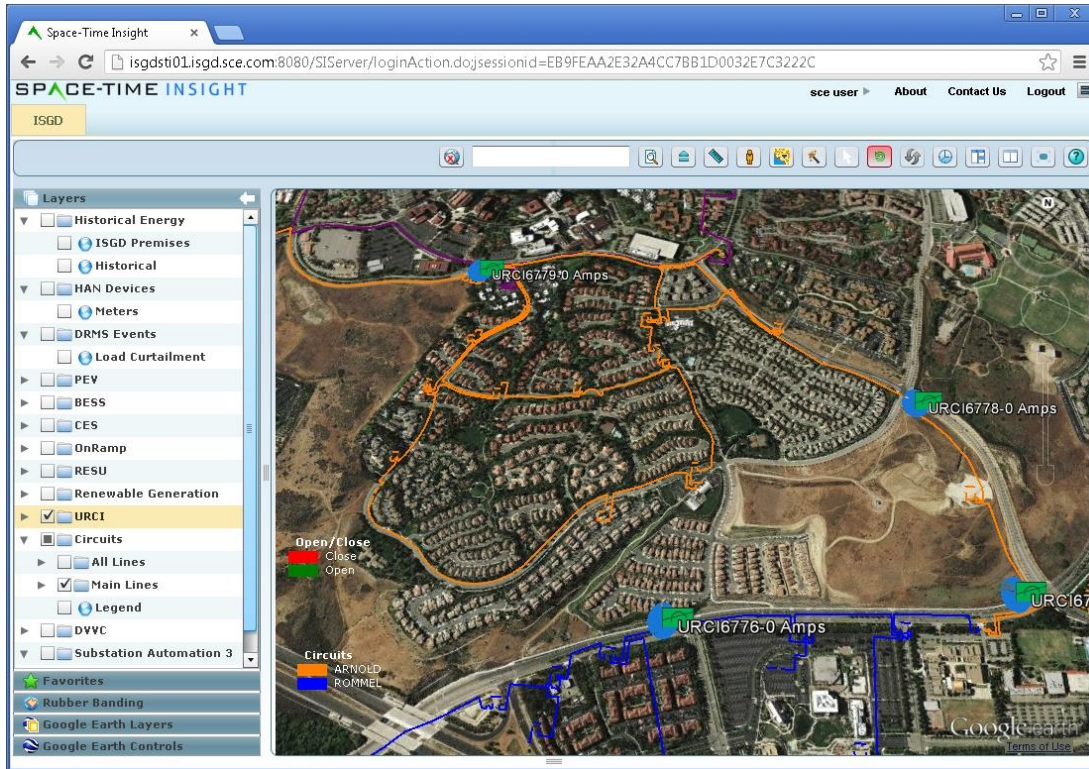

3.3.1.4 Deployment

ISGD is using two environments for SENet.

- **Lab Test Environment:** This environment resides within SCE’s Advanced Technology Labs. Test equipment was assembled and configured to resemble the production environment, to the extent possible.
- **Pilot Production Environment:** This environment resides within an existing grid control center, within a new network domain.

The team used both environments to conduct three phases of testing per system. The team performed each series of tests in the Lab Test Environment before performing them in the Pilot Production Environment. The systems were accepted and commissioned only after all tests were either successful or withdrawn.

- **Component Testing** was performed by the component developer. All tests were documented and issues were identified prior to attempting any testing with other components.
- **String Testing** involved testing data flows between components, starting with simple exchanges, and then progressing to more complex or longer scenarios.
- **End-to-end Testing** helped the team to verify that business requirements were satisfied with all equipment, communications, and required functionality.

In addition to the above testing, in certain cases the team performed simulations in order to run scenarios that would be difficult or impossible to run with the actual equipment in the field.

3.3.1.4.1 Network Infrastructure

Figure 10 provides an overview of the equipment, locations, and network links involved in the system.

Figure 10: ISGD System Network Infrastructure Overview

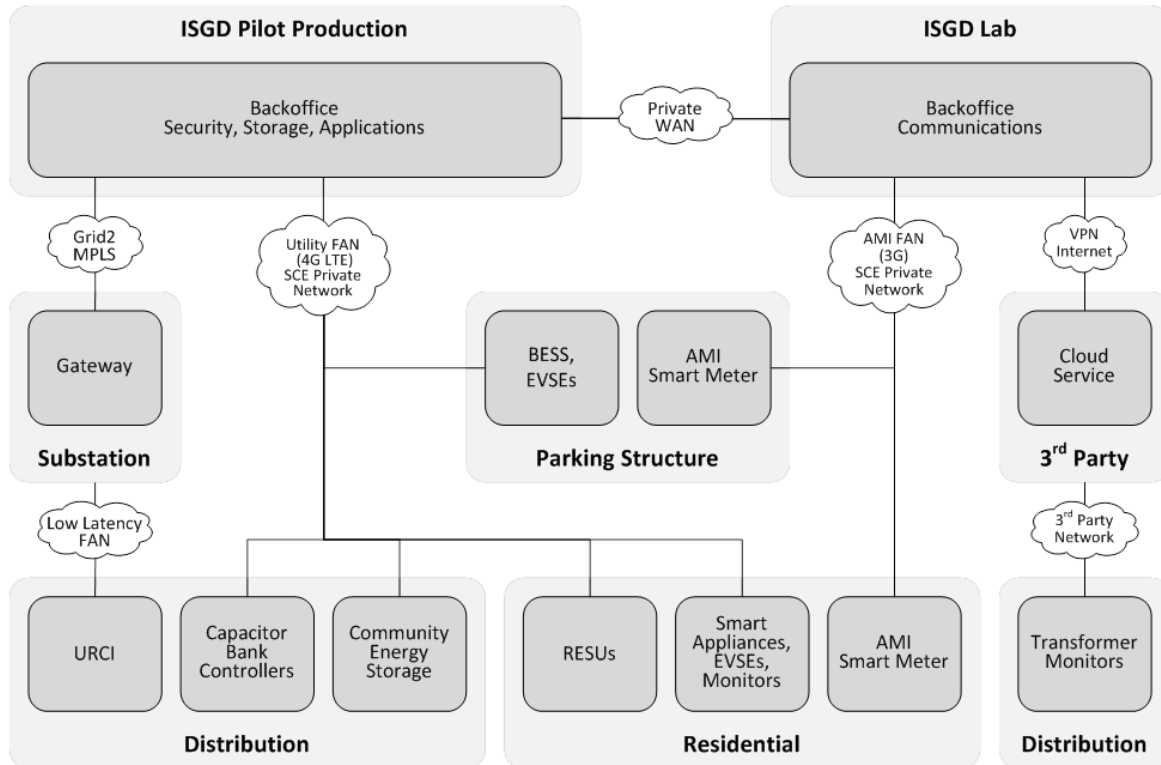

Customer Home Area Network

HAN devices in the customer premises and plug-in electric vehicle chargers at the Solar Car Shade parking structure both support the Smart Energy Profile 1.x (SEP 1.x) protocol. These devices are capable of receiving demand response signals through project smart meters, or through a home energy management gateway device, which receives the signals through a project smart meter. The home EMS is used in the sub-project 1 customer homes (not the solar car shade). The home EMS is a gateway that may be joined with a customer Wi-Fi network to allow controlled access to HAN devices via a customer device using a smartphone app. This gateway may also use a public carrier secure connection to store data from the HAN devices on a “cloud” home EMS server (if the customer elects to register with the home EMS vendor for this service).

Field Area Network

There are four field area networks: the AMI FAN, the 4G Utility FAN, the Low-Latency FAN, and the legacy Netcomm radio network.

The AMI FAN is a secure radio frequency (RF) mesh network with an SCE private network over a 3G wireless public carrier backhaul, using a demilitarized zone (DMZ). The DMZ is a network set up specifically to provide only the functionality needed for communications to external systems (in this case, the AMI system), prevent unauthorized access, and pass authenticated electronic communications along to back office systems in higher security level networks. This network provides communication of usage measurements from project smart meters and EVSE sub-meters, and demand response event signals.

The RESUs, CES, BESS, and TrendPoint circuit monitoring systems are securely connected to the back office via the Utility FAN (an SCE private network over 4G public carrier backhaul). This Utility FAN provides a secure, high bandwidth connection for transmitting data with higher sample rates, and for sending frequent commands.

The Low-Latency FAN connects the URICs, which are outside of the substation, to the substation gateway. The Low-Latency FAN uses a secure RF network with an access point on the URCI LAN at the substation. Devices on the Low-Latency FAN communicate through the substation gateway to the ISGD Pilot Production network. These FAN devices and networks support enhanced situational awareness of the distribution system. The Netcomm radio network supports the field capacitor controllers for DVVC.

Internet

On-Ramp Wireless devices monitor the distribution transformers on each of the four blocks of customer homes. These devices connect to the vendor’s cloud server via a secure wireless network. The ISGD Vendor DMZ retrieves data from the cloud server using a site-to-site VPN over the public Internet. The ISGD Vendor DMZ provides a secure connection to the ISGD back office systems.

Substation LAN

The substation LAN supports control, protection, and measurement applications for devices located within MacArthur Substation. The substation gateway provides support for legacy and proprietary systems, potentially handing all communications to and from the substation, and eliminating all other channels, such as serial (“dial up”) connections. Devices on the substation LAN can connect with legacy communications links (principally the EMS SCADA) via the substation human-machine interface (HMI) to support both channels during testing.

Intra-utility WAN

Devices connected to the Intra-Utility wide area network (WAN) high-speed backbone have fiber connectivity to other such devices, substations, and head-end systems in data centers and grid control centers. The high-speed backbone supports control, protection, and measurement applications with MPLS, DMZs, and VPNs to assure the integrity and confidentiality of ISGD data/control from other SCE users on this backbone.

3.3.1.4.2 Computing and Storage

Hardware

The ISGD project uses 16 blade servers with storage area network (SAN) storage as the main computing environment in the back-office. The Lab Test and Pilot Production back office environments have similar hardware. ISGD is also using online and tape backup equipment, network switches, routers, management and monitoring equipment, a virtual desktop user interface server, and two additional rack-mounted application servers.

In addition to the back-office locations (Lab Test and Pilot Production), the project has installed equipment in MacArthur Substation, on two 12 kV circuits fed by MacArthur Substation, in the project neighborhood and participant homes, and within the Solar Car Shade parking structure.

Software

Table 13 summarizes the major software applications used for ISGD.

Table 13: ISGD Software Applications

Application	Functionality
Circuit Monitoring	Monitors energy usage on multiple circuits within a home. Supports analyzing the effect of smart appliances and other energy efficiency measures.
Demand Response	Manages, dispatches, and tracks DR events and programs.

Application	Functionality
Advanced Metering Infrastructure	Captures 5-minute directional usage and voltage from smart meters, and supports ZigBee Smart Energy 1.x for sending DR signals to smart appliances.
Residential Energy Storage Unit	Contain energy storage and inverters for the rooftop solar panels.
Battery Energy Storage System	Paired with 20 electric vehicle charging stations and a rooftop solar PV system to support PEV charging.
Community Energy Storage	CES is a distribution scale battery for peak shifting, islanding, and other functions.
Transformer Monitoring	The On-Ramp Wireless system provides transformer measurements securely over the Internet.
Substation Gateway	The substation gateway provides communications and substation configuration management services.
Distribution Management System and Energy Management System	Model the distribution and bulk power systems to provide a variety of operational functions. The URCI and DVVC functions were added for ISGD.
Universal Remote Circuit Interrupter	URCIs provide self-healing functionality to preserve power to segments of a looped circuit not containing a fault.
Distribution Volt/VAR Control	Operates in the ISGD DMS system to optimize voltage by controlling capacitor banks based on monitored grid inputs.
Enterprise Service Bus	Integrates AMI, meter data services, TrendPoint, On-Ramp Wireless, BESS to Oracle for visualization.
Visualization	Contains custom views of project data integrated within Google Earth.
Cybersecurity	See section 4.3.1.1.2 for a description of the cybersecurity functions.
Operating System	Manages physical resources (memory, disk, and network) for the software resources running on the hardware.
Relational Storage	Stores general-purpose tabular data.
Data Historian	Stores numeric values as time-series data.

3.3.1.5 Design Considerations and Findings

The ISGD design went through a number of revisions during design and engineering phase. This section describes aspects of the design and implementation that required the team to consider alternatives and the associated tradeoffs.

3.3.1.5.1 Field Area Network Backhaul (4G)

Secure and reliable communications with field devices is a critical foundational element of a smart grid. Communications networks typically require a combination of technologies, depending upon the number of communicating nodes and the required bandwidth. Mesh networks are often cost-effective if the nodes are close enough together. Mesh networks allow multiple devices to share a longer-range backhaul communications links, potentially avoiding duplicate expenses.

- **Short range, broadcast:** Wi-Fi, Wi-Max, and other home area wireless networking technologies, as well as home wired standards such as Ethernet, are appropriate over short distances, or longer distances if linking them together with a mesh network. However, long-range, point-to-point links are necessary for transferring large amounts of communications traffic from central servers to these network devices.
- **Long-range, point-to-point:** Fiber-optic, copper, point-to-point wireless (using parabolic dishes), satellite, line-of-sight optical, and cellular (3G or 4G) communications can all support long distance communication. However, these technologies may be expensive to install, and/or could require a service provider with monthly fees. Certain applications may be able to justify exclusive using this type of communications

(applications used for grid control, for example). But for general-purpose coverage, sharing these links may be necessary.

A number of factors contribute to the preferred FAN design, including bandwidth and latency requirements, existing spectrum and other communications infrastructure, technology maturity, and capital investment constraints. The design needs to balance cost, performance, and schedule requirements.

The ISGD team elected to use a dedicated 4G LTE cellular data backhaul due to its versatility, technological maturity, coverage, cost, and availability. Since deploying this 4G network, the team has found that 4G provides more bandwidth than most smart grid applications require; 3G may be viable in some scenarios. Future projects may explore the use of mesh networks (e.g. Wi-Fi or Wi-Max) in addition to 4G communications.

3.3.1.5.2 Hardware and Environment

Wireless communications are sensitive to a number of environmental factors. Achieving consistent and reliable connections requires attention to a number of factors, including the following:

- Optimization of radio and antenna placement
- Use of external antennas or repeaters in areas with low signal strength
- Antenna extension cables of the correct length
- Power supply and correct circuit protection sizing
- Regulation of temperature to rated limits
- Control of dust and humidity
- Interference or signal degradation from enclosures
- Disruption of transmission due to reflections from walls and other objects

Radio form factor is another design consideration. In general, smaller enclosures are more expensive, while large enclosures may be difficult to fit within existing equipment. Weatherproofing and physical security is required if equipment is outside.

Multiple components span the communications paths between field devices and back office systems. Such components include incoming links to communication rooms, internal networks and security components (e.g., switches, routers, firewalls, VPNs, and the connections between them). These components each represent potential points of failure that could disrupt communications. Common causes of disruptions to network equipment include power interruptions, wear due to improper operating conditions such as heat or dust, use of equipment beyond its recommended life, and incompatibilities following upgrades and configuration changes.

3.3.1.5.3 Software and Firmware

ISGD has a large number of communications nodes. Manually executing configuration commands (e.g. upgrading firmware) for each node is time consuming, and therefore requires management software. Since communication links are sometimes unreliable, this software must monitor command successes and (if necessary) retry to ensure completion. Since configuration files can be complex, the software must also be capable of managing each version of each configuration.

The team discovered a number of issues among the components that connect to the field devices, including incompatible versions or implementations of protocols such as Transport Layer Security (TLS), IPsec, SCEP, and Dynamic Host Configuration Protocol (DHCP). When using new devices with custom features, time and effort is required to work through these issues.

Integrating individually developed modules or components into a single unit can also present challenges. For example, interactions between the internal components or modules can cause conditions that are difficult to diagnose and might not be possible to fix in the current component versions. For example, the 4G functionality in

the 4G radios was implemented in a circuit board module that was integrated with other radio components such as Wi-Fi and CCS. Since the code for the 4G module was not under the radio vendor's control, brute force (such as rebooting a module) was sometimes necessary to resolve problems. Temporary workarounds may be necessary to resolve these types of issues, but this can cause stability problems until the underlying issues are resolved.

3.3.1.5.4 Network Congestion

Field devices connect directly to the 4G network, where they are provisioned and tracked using vendor SIM cards. To connect the 4G network to the back office, the project uses a private network connection from the wireless network provider to the internal SCE network. However, the 4G network itself is still shared across all devices connecting to the 4G towers and is therefore subject to service degradation during times of peak usage.

3.3.1.5.5 Troubleshooting

Maintaining the signal strength of the 4G network was a challenge during deployment. To address this challenge, the team prepared daily reports on the received signal strength indicator (RSSI), and events such as cell disconnections. This helped the team to optimize the antennas for the best reception. When planning field installations, projects should try using alternate equipment placement, antennas, and configurations—while also monitoring signal strength. Projects should also test communications with enclosures both open and closed. This helps to ensure that communications are stable before leaving the site.

Network equipment in the field should operate continuously and autonomously. However, this type of equipment is not immune to rare, complex memory management or timing bugs, electromagnetic disturbances, or other long-term abnormalities. When problems occur, traditional methods of troubleshooting (such as power cycling) are not available for this equipment, since it is not physically accessible (i.e., the devices are located in the field, inside electrical equipment enclosures). If the equipment has stopped communicating, options are limited. If possible, a secure method for remotely rebooting equipment that has stopped communicating would decrease downtime. If a remote reboot is not possible, a method for securely rebooting from a nearby location, but without having to open enclosures or enter customer residences or facilities, would be useful.

In an effort to monitor and maintain network stability, the team evaluated several network monitoring tools. While there are many viable network monitoring tools available, configuring them to provide an appropriate level of reporting and notification is challenging. In order to receive alerts if the production network is down, it is necessary to establish a monitoring mechanism outside the production network. ISGD is using HP System Insight Manager and Solar Winds Network Performance Monitor to monitor the systems and send e-mail alerts when they detect problems.

3.3.1.5.6 Guaranteed Delivery of Communications

A common misconception about communications networks is that they guarantee message delivery. Communications networks will attempt to resend messages if a delivery failure occurs. However, the message will “timeout” if communications are lost for too long. To avoid this problem, applications require strategies for queuing and retrying, which requires storing unsent messages in case the network is down for an extended period. These strategies should consider the business requirements around loss of data. The following is a list of issues to consider when designing communications capabilities:

1. Applications require a retry strategy for when network communications fail
2. Applications must not simply log an error when a communication link is not responding
3. Devices must contain some storage of historical readings or data in order to support retry
4. Exponential back off (waiting successively longer intervals between retries) is useful for recovering quickly while not wasting resources during longer outages
5. Applications must not store or report false (or estimated) values without indicating they are false (or estimated)

3.3.1.5.7 Interoperability Design Approach

The electric utility industry has focused on interoperability standards as a way to reduce smart grid implementation costs. Such standards should enable applications to communicate and react to information exchanged with other applications. The ISGD project team has found that interoperability continues to be a challenging aspect of smart grid deployments.

Two approaches to achieving interoperability include using standard interfaces and performing custom integrations. Both approaches require careful consideration of the associated design decisions and tradeoffs.

Standard Interfaces

While it may be possible to procure a number of smart grid capabilities from a single vendor, SCE prefers to procure open and standards-based interoperable system components from multiple vendors. This approach promotes market competition and innovation. A vision embraced by many in the utility industry is that vendor software should implement standard interfaces, enabling devices and applications from multiple vendors to interoperate without requiring costly integration services.

Intellectual property law is one reason why vendors are cautious towards this approach. The threat of patent infringement lawsuits makes vendors cautious about implementing standards. Vendors often rely upon proprietary communications to mitigate this risk, restricting their use of standard communications to where it is necessary.

Standards are typically most effective when vendors form an industry alliance or consortium that requires legal agreements between parties, and defines and enforces governance processes. Alliances can certify products as interoperable, usually for specific exchange scenarios defined by profiles. Examples of multi-vendor alliances include Wi-Fi, Bluetooth, and ZigBee.

Custom Integration

Integrating applications that were not designed to interoperate with each other requires substantial effort. Various technical approaches may be useful, such as using messaging middleware or service oriented architecture, extracting, transforming and loading files, or using database gateway tables. Regardless of the tools and platforms used, translating between data formats and orchestrating the exchanges requires custom code. Vendor-supported application programming interfaces (APIs) are preferred for integrating applications, over use of native database or file formats. Likewise, standards-based interfaces (such as web services) help to reduce the complexity of adapters.

Integration work is generally divided among vendors, system integrators, and in-house developers. Dividing the integration responsibilities inevitably leads to disagreements and misunderstandings. Assigning overall responsibility to a single entity can mitigate this challenge. Custom integrations require highly effective communication and collaboration among diverse groups.

3.3.1.5.8 NERC CIP v5

The North American Electric Reliability Corporation (NERC) is responsible for ensuring the reliability of the bulk power system in North America. NERC's Critical Infrastructure Protection (CIP) standards provide guidance and requirements for securing the bulk electric system. The latest version of this standard clarifies the applicability of cybersecurity protections to serial (non-routable) connections. One of the goals of ISGD is to demonstrate implementation of the recommended cybersecurity measures to and from a substation through a secure communications gateway. This approach uses routable protocols over a WAN fiber link to the grid control center. Although this substation is not classified as part of the bulk electric system, SCE's goal is to eventually implement high-capacity, secure, IP-routable electronic communications capabilities for all substations.

SCE developed the CCS specification to meet the requirements of NISTIR 7628, the National Institute of Standards and Technology Interagency Report on Guidelines for Smart Grid Cybersecurity. The CCS specification was used as

a set of requirements for the vendors that implemented the central security services in the back office, as well as the software clients in the substation gateway and the 4G radios used for certain field devices. The solution uses IPSec instead of TLS or Secure Sockets Layer (SSL), allowing security to be built into a lower layer of the Internet protocol suite (as shown in **Figure 11**). This allows application traffic protection without requiring those applications to be specifically designed to use IPSec.

Figure 11: IPSec in the Internet Protocol Suite

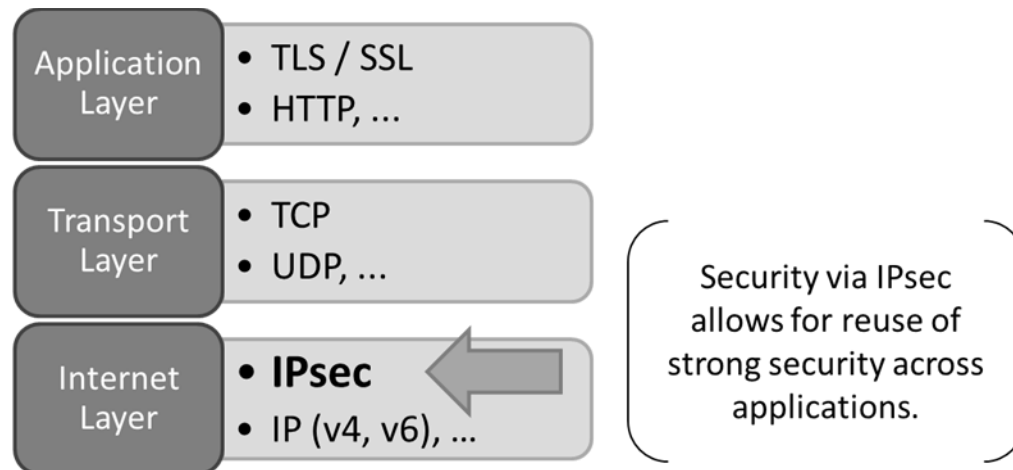

3.3.1.5.9 Scalability

In order for smart grid capabilities to be widely deployed, they must be scalable. Certain ISGD components are scalable, including off-the-shelf software applications and database hardware. Other ISGD components require further evaluation to assess their scalability, including the networking infrastructure. The ISGD team plans to perform simulations to evaluate how the ISGD communications network performs under various conditions and with various levels of data throughput. The team will also assess how the Common Cybersecurity Services capability affects network performance. The results of these evaluations will be included in the Final Technical Report.

3.3.1.5.10 IT Capability Maturity

The smart grid requires mature communications and computing capabilities to support the advanced use of operational technologies (e.g., physical grid equipment such as transformers, capacitor banks, relays, and switches). Utilities have long thought of operational technology as separate from IT, which initially focused on financial records, billing, and other “non-operational” functions. However, most operational equipment now includes some amount of electronic monitoring, communication, and even automated remote control functions. This automation requires an increased role for IT.

Each of these automated functions requires hardware and software that must be maintained and integrated with other applications or hardware. They also require databases for reporting. Maintaining this IT infrastructure is especially complex given the need to periodically add functionalities, perform upgrades, and change hardware, networks, or security. The following is a list of key questions that IT departments should be able to answer:

1. **Vision** – What are the long-term goals of the company, and how will customers, shareholders, regulators, company business units, and projects support it?
2. **Business Case** – How are projects evaluated and selected?
3. **Governance** – Who makes decisions about resources used by multiple business units?
4. **Requirements management** – What should each component do, specifically? What if a requirement changes?

5. **Configuration management** – Which versions of the software and hardware are in use?
6. **Test equipment and environments** – How are changes evaluated to ensure they will not cause problems?
7. **Manage process changes** – How is confusion from and resistance to change minimized?
8. **Customer communications** – How are customers included in managing these changes?

Advancing the maturity of the IT organization can improve the efficiency and effectiveness of smart grid technology rollouts.

3.3.1.6 Research Plan

Following the architecture and design phase, vendors built the individual ISGD sub-systems. Once these successfully passed factory testing, they were installed at the SCE lab for further testing and full system integration. Following SCE lab installation, the team conducted comprehensive performance testing on the integrated production networks. The team will conduct performance testing during the measurement and verification period. This testing will address performance of the ISGD networks, security, interoperability, and visualization. This results of this testing will appear in the Final Technical Report.

3.3.2 Sub-project 7: Substation Automation 3

3.3.2.1 Objectives

The goal of SA-3 is to transition substations to standards-based communications, automated control, and an enhanced protection design. Achieving these goals will support system interoperability and enable advanced functionalities such as automatic device configuration and backward compatibility with legacy systems.

3.3.2.2 Approach

The MacArthur Substation SA-3 pilot is demonstrating the following:

- An open standards-based human-machine interface (HMI), which helps avoid vendor lock-in
- Password management (user-specific, role-based passwords)
- Fully-automated substation device configuration
- Secure and remote access
- IP-based data and control communications
- Integration of CCS
- Process improvements
 - Project engineering (project file creation) efficiencies due to SEMT (Substation Engineering Modeling Tool) improvements
 - Factory acceptance testing and on-site testing process improvements due to standards-based device auto-configuration processes
 - Remote visibility and control of field devices
- Centralized distribution volt/VAR control
- Integration of DMS with substation control

The SA-3 design incorporates IP-based intelligent electronic devices (IEDs), a programmable logic controller (PLC), an industrial hardened HMI, and substation gateway integrated with CCS. One of the advantages of SA-3 is to enable device auto-configuration, compliant with the IEC 61850 standard, eliminating the need for manual configurations. The substation gateway securely bridges the low-latency FAN to the substation local area network (LAN), enabling the self-healing circuit capabilities of sub-project 5. Lastly, SA-3 allows SCE to compare the advantages or disadvantages of operating DNP3 (Distributed Network Protocol) over IP communications in lieu of the current DNP3 over serial communications.

SA-3 is a foundational element required for ISGD to implement sub-projects 3, 4, 5 and 6. SA-3 provides the secure communications, remote monitoring, and control schemes necessary for these sub-projects.

This section provides an overview of the primary SA-3 components, and describes the new features and capabilities of the system. This section also summarizes the challenges the team faced during deployment.

3.3.2.3 Design

ISGD's SA-3 design includes several key components, which are identified in **Figure 12** and described in further detail below.

Figure 12: SA-3 Network Architecture

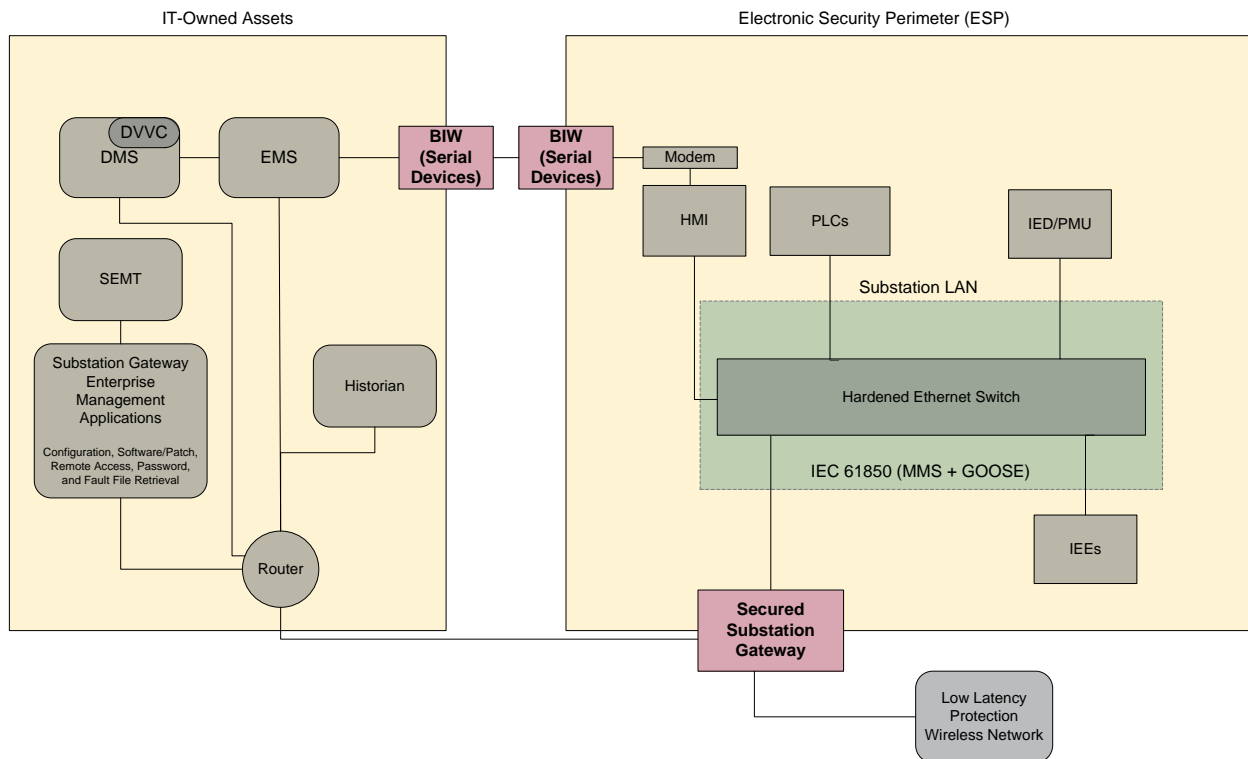

PowerSYSTEM Center

The PowerSYSTEM Center application suite provides centralized configuration management and automated configuration support for the substation gateway. This software suite includes the following:

- Repository for substation metadata and equipment inventory
- Version controlled repository for device configuration files
- User access and change control for specific configuration elements
- Automatic capture of field configuration changes (in conjunction with SubSTATION Server)
- Remote, secure engineering and maintenance access to substation IEDs using proprietary vendor tools (myIEDs)
- Password management of access to individual substation devices such as the substation gateway, managed switches, HMI and IEDs (myPasswords)
- Automatic capture of device fault records (myFaults)

Substation Gateway

The substation gateway consists of software running on an environmentally hardened, scalable processor and data concentrator. This provides a single, secure, enterprise-wide point of access to substation data. This provides the following capabilities:

- Automatically retrieves all substation event and disturbance records for secure, centralized processing and storage
- Hosts integrated Common Cybersecurity Services to enforce corporate security policies
- Acts as the substation communications hub by enabling local or remote access to field devices

Engineers and technicians have secure, local access to the substation gateway via Remote Desktop Protocol using a dedicated Ethernet access port. The substation gateway enables secure two-way pass through to the substation IEC 61850 LAN. Authorized users are therefore able to access individual device configurations and settings. This is the primary process for configuring SA-3 system relays. The substation gateway with Common Cybersecurity Services provides secure access of Critical Cyber Assets (CCA), something that the current IEDs cannot provide.

Human Machine Interface

Authorized operations and maintenance personnel use the HMI for local supervisory control of substation apparatus (circuit breakers, switches, reclosers, relays, etc.). The HMI acquires, transports, and presents real-time operational data locally and to the SCADA EMS (Energy Management System). The HMI can now be modified automatically via the substation gateway using Substation Engineering Modeling Tool (SEMT) configuration files.

Managed Gigabit Ethernet Switches

The substation managed switch network consists of an array of RuggedCom® RSG2100 Modular Managed Gigabit Ethernet Switches connected in a ring configuration. This allows for rapid network reconfiguration in the event of a network link failure.

IEC 61850 Protective Relays

Primary and backup substation protection, metering and control functions, and data communications are using state-of-the-art IEC 61850-compliant microprocessor-based GE UR (Universal Relay) and SEL relays (also known as IEDs.)

The IEC 61850 protective relays introduce new communications protocols to the SA-3 system design: MMS (Manufacturing Message Specification) for reporting, polling, and controls; and GOOSE messages for publishing and subscribing to relay data.

Phasor Data Concentrator

MacArthur Substation is using a SEL-3373 PDC to archive phasor data locally at the substation. This PDC stores data from the 66 kV lines coming into MacArthur Substation (GEUR D60), the two 66/12 kV transformer banks (GEUR T60 relays), and from the Arnold and Rommel 12 kV distribution circuits (GEUR F60 relays). This data supports the deep grid situational awareness capability in sub-project 6.

Substation Engineering Modeling Tool

The SEMT is a software application used by SCE to create artifacts required to configure substation automation devices including IEDs, managed switches, the substation gateway, and the HMI. Primary SA-3 improvements involve the creation of artifacts which are now IEC 61850 standards-based, and Substation Configuration Description (SCD) files, which drive the SA-3 substation gateway configuration process. The SEMT will remain backwards compatible with earlier versions of substation automation, and can support point list generation for substations based on these earlier versions. The SEMT also now generates reports such as point list, the Applied Systems Engineering Inc. test set, and HMI test scripts.

3.3.2.4 Key Features of SA-3

The SA-3 System introduces the following new features and functionality to SCE's existing Substation Automation system design.

Configuration Management

Introduces an array of tools to configure, compare, and secure settings on system devices (e.g. relays, phasor data concentrators). Specifically such tools include:

- Automatic generation of SCD files which are then parsed and stored in the PowerSYSTEM Center Central Management Services (CMS) repositories
- Automatic device configuration when updating a substation
- Substation gateway interoperability with the PowerSYSTEM Center CMS is responsible for local and remote monitoring of system devices for operating status, configuration changes and access authorization
- Identification and notification of file changes, also known as "incremental differencing" (i.e., system identification of any change to any device configuration or setting)
- Device firmware version and patch management of operating systems, software and firmware
- Device password management for IEDs, HMI, managed switches and the substation gateway

Automatic Event and Fault File Recovery and Management

This function centralizes access to event files (such as system faults) by enabling automatic device polling and data archiving. Protection engineers currently access these files locally at the substation.

Remote Secure Engineering Access

Substation engineers are able to remotely access substation device data. This can be valuable to protection engineers in validating specific in-service protection settings following a fault. The ISGD team uses this capability to access and upload PMU data from the PDC.

New Human Machine Interface

The SA-3 HMI automatically generates substation one-line diagrams based on the SEMT output, resulting in completely data-driven configuration. These diagrams are linked to SCADA systems for operations and maintenance. This eliminates the time and expense of having a proprietary HMI vendor generate project HMI configurations based on SCE-generated point lists. This time consuming and error prone process required additional Protection Automation Development subject matter expert support to debug vendor-provided project HMI configurations.

Enhanced Protection Schemes

Recent advances in energy and information technologies allow for improved circuit protection schemes that were not possible with legacy devices. For example, protection schemes for the 66 kV and 12 kV circuits into and out of MacArthur Substation have been migrated to IEC 61850-compliant relays. These relays use peer-to-peer GOOSE messaging for Permissive Trip Bus (PTB) protection. The project is also evaluating high impedance-fault detection on the Arnold and Rommel 12 kV distribution circuits.

Common Cybersecurity Services

The substation gateway has implemented CCS, providing secure communications paths between MacArthur Substation and the back office, and between MacArthur Substation and the field area network.

System Optimized for IEC 61850

The system supports simple integration of IEC 61850-compliant devices from multiple vendors.

3.3.2.5 Deployment Challenges

3.3.2.5.1 Back Office Integration

Depending on a utility's current back office functionality, introducing a substation automation system may pose integration challenges. Specifically, the additional data provided by SA-3 may impact operational systems such as the Energy Management System and Outage Management System. Other systems such as data historians, circuit protection repositories, and fault file databases will also need to establish interfaces with the new substation automation application. Utilities considering an advanced SA-3 system should establish key system requirements and identify the impacts to any existing systems. Some systems may be unable to interface with SA-3, and these could require replacement.

3.3.2.5.2 Interpretation of IEC 61850

When deploying complex systems, utilities typically procure hardware and software from a single vendor. This helps utilities avoid having to manage device interoperability, thereby mitigating deployment challenges. However, avoiding vendor lock-in requires that multiple potential vendors exist for these products.

SCE's SA-3 design incorporated IEC 61850-compliant software and hardware from multiple vendors. The primary objective of this standard is to achieve interoperability among devices from multiple vendors. The effort required to integrate these components into one system highlights the current lack of interoperability within the industry. Many manufacturers claim to offer products that are IEC 61850-compliant. However, their interpretations of the standard are inconsistent. This made their devices unable to communicate with one another.

The IEC 61850 suite of standards is intended to be flexible. This flexibility was instrumental in allowing SCE to create the necessary "private data," which enables interoperability between most vendor devices. However, this flexibility increases the standard's complexity, while also introducing the potential for different interpretations among various vendors. The ISGD team experienced this issue when it received relays from two vendors. Although these relays were both IEC 61850-compliant, they would not interoperate. This lack of interoperability led to longer than expected laboratory testing and coordination with product manufacturers.

The ISGD team coordinated the development and evaluation of solutions for these integration challenges among the ISGD vendors. The team also invested a substantial amount of time testing the functionality and interoperability of the SA-3 system in SCE's Substation Automation Lab. This lack of interoperability caused schedule delays and budget overruns, while the team also had to make some compromises on functionality due to the limited amount of time available to address these technical challenges. While two devices may conform to a standard, this does not automatically ensure interoperability. Interoperability certification by an independent testing laboratory would ease this problem.

3.3.2.5.3 Old versus New Processes

Instituting a substation automation system not only affects systems, it also influences the operational processes associated with these systems. As SA-3 integrates with or replaces operational systems, it will lead to procedural changes. For example, to configure the protection settings of substation protection devices, protection engineers currently load protection setting files to a database. Field personnel then manually download these files, take them to the substation, and manually input them into the substation devices. SA-3 enables authorized field personnel to download these files directly to the substation gateway and to auto-configure the substation devices directly from within the substation. Although such procedural changes may seem trivial, the ramifications across system operations can be significant. SA-3 impacts back office processes as well as processes within the substation. Substation test technicians and other field workers are now required to operate a new HMI with active directory password management. Device configuration occurs via a substation gateway rather than directly through the device. The primary reason for this process change is that the substation gateway (with CCS) now enables secure user access to IEDs. The impacts to operational processes can be challenging to identify, and even more difficult to

implement. Utilities planning to adopt a substation automation system should obtain stakeholder buy-in early in the process. They should also obtain support from corporate training.

3.3.2.5.4 Engineering the Substation

Traditional substation engineering practices include developing electrical engineering plans and manually inputting them into modeling tools. One of the options SCE may pursue as part of a future SA-3 deployment (after the ISGD project is complete) is to incorporate computer aided drafting (CAD) to help automate design and modeling processes. This could eliminate the need to manually input substation configuration files into a modeling tool. Rather, after completing the electrical plans, the CAD software would automatically generate a set of substation files. A modeling tool would then read these files and automatically generate a point list. The modeling tool would then use this point list to generate the standard configuration files, consisting of communication, automation logic, protection settings, and HMI screens.

3.3.2.6 Research Plan

3.3.2.6.1 Simulations

The team performed steady-state circuit modeling to support the development and debugging of the SA-3 system.

3.3.2.6.2 Laboratory Tests

The ISGD team tested the system components before field installation to verify performance and functionality. Laboratory testing included component communication, password management, protection settings, logic configuration, and auto-configuration. By using a mobile Real-Time Digital Simulator, the team simulated thousands of system conditions and evaluated the SA-3 responses. Following these simulations, the team performed end-to-end interoperability and system integration testing at SCE's Advanced Technology facility. The final stage of testing included interface simulations with the Energy Management System (EMS), DMS, eDNA (archiving software), enterprise configuration management software (i.e., PowerSYSTEM Center), and the FAN.

3.3.2.6.3 Commissioning Tests

The deployment strategy for the SA-3 system followed SCE's existing construction and commissioning standards. These standards require qualified electrical workers to validate circuits, protection settings, and control logic. The introduction of new SA-3 functionalities requires additional work including device auto configuration and configuration management testing (e.g. remote secure access and password management).

3.4 Workforce of the Future

This project domain provides the workforce training tools and capabilities necessary to operate and maintain the various ISGD components. The sub-project is also evaluating the potential impacts of smart grid technologies on the organizational structure of the utility.

3.4.1 Workforce Training

The ISGD team developed training materials for the ISGD project in accordance with the ADDIE process. This process enables the authoring of training content through five major stages: (1) analysis, (2) design, (3) development, (4) implementation, and (5) evaluation.

3.4.1.1 Stage 1: Analysis

The team conducted a training needs analysis by identifying the transmission and distribution (T&D) personnel impacted by ISGD, and then assessing how ISGD would affect their roles. The job classifications included Linemen,

Troublemakers, System Operators, Substation Operators, Distribution Apparatus Test Technicians, Substation Test Technicians, and Field Engineers. Each of these personnel has specific roles with respect to operating and maintaining MacArthur Substation and the Arnold and Rommel 12 kV circuits. Therefore, at a minimum, these personnel need to understand ISGD's scope and its various field components.

Through discussions with ISGD subject matter experts (SMEs) and field personnel, the team determined that many tasks these personnel are responsible for would not change substantially due to the technologies introduced by ISGD. However, these personnel would need to understand how these technologies work. They would also need to understand how to work with these components if they experience a failure in the field. The ISGD technologies are not introducing fundamental changes in the required knowledge, skills, or abilities. However, in some instances there is a convergence of information technology with operations technology skills due to the communications capabilities of the field devices. In most cases, the ISGD technologies represent a logical extension of current technologies.

3.4.1.2 Stage 2: Design

To ensure that field personnel are properly equipped with the knowledge necessary for working with the ISGD technologies when performing their daily duties, the team decided to produce introductory classes and role-specific reference content. Key reference documents are also available to personnel on an as-needed basis.

There are three deliverables associated with the project: (1) role-specific job aids, (2) introductory classroom training, and (3) an online training repository.

Role-Specific Job Aids: Job aids help to describe specific installation, operations, and maintenance activities in detail for specific job classifications.

Introductory Classroom Training: Impacted field personnel and their supervisors received classroom-training sessions led by the ISGD project managers and engineers, in partnership with the T&D Training organization. These classroom sessions covered overviews of the ISGD project, as well as details associated with the ISGD components affecting T&D.

Online Training Repository: A training repository tool provides personnel with fast, organized access to electronic versions of the ISGD training content, vendor documentation, and related internal SCE standards. This tool covers a self-guided basic overview of the project, as well as an intuitive user-interface, enabling the learner to find content quickly and efficiently.

3.4.1.3 Stage 3: Development

The team developed the three workforce training deliverables as follows:

Role-Specific Job Aids: SCE personnel developed job aids and captured all of the images during equipment mock-ups or actual installations.

Introductory Classroom Training: The team developed classroom-training sessions with heavy input from SMEs and project personnel.

Online Training Repository: The team developed the online training repository using an eLearning authoring software package. This software provided flexibility in designing the user interface, as well as the capability to effectively organize the content.

3.4.1.4 Stage 4: Implementation

The classroom training occurred between November 2013 and January 2014 for all personnel impacted by the CES device, DBESS, DVVC, URCI, and SA-3. During the classroom training, all personnel received hard copies of the training content for their reference and review.

3.4.1.5 Stage 5: Evaluation

The team performed informal evaluations throughout the training courses by collecting feedback from employees. Formal evaluations forms were provided during a few training sessions, and the feedback was generally positive. A feedback survey option will be included for any personnel accessing the online training tool.

3.4.2 Organizational Assessment

The organizational assessment will take place in late 2014 and early 2015, and the team expects to complete it within the first quarter of 2015. ISGD will report on this aspect of the project in the Final Technical Report.

The objectives of the organizational assessment are to analyze the organizational impacts of implementing new technologies, and to develop recommendations and industry best practices for addressing these impacts. The assessment will address organizational impacts, organizational design, organizational readiness, and associated lessons learned from the ISGD project. The team will develop an organizational assessment report that includes the following:

- Identifies the most effective future organizational structure
- Compares the current and future organizational structures to identify the largest gaps and potential obstacles
- Specifies how future organization functions and responsibilities will differ from current ones, including changes in workforce size, organizational hierarchy, and the organizational functions
- Identifies policies and procedures necessary to facilitate the identified changes
- Identifies industry best practices for designing organizations that adequately support smart grid technologies

4. Results

This chapter summarizes the simulations, laboratory testing, commissioning tests, and field experiments used to assess the various ISGD technologies. The first TPR focused on ISGD's engineering, design, and deployment activities, and the first eight months of field experiments. This second TPR summarizes the ISGD commissioning activities and field experiments from the second eight-month period.

4.1 Smart Energy Customer Solutions

4.1.1 Sub-project 1: Zero Net Energy Homes

ISGD has deployed a number of IDSM technologies to understand their impacts on the customer homes and electric grid and to assess their contributions toward enabling homes to achieve ZNE. This section summarizes the energy simulations, laboratory tests, commissioning tests, and field experiments used to assess these technologies.

4.1.1.1 Energy Simulations

The first TPR summarizes the results of the sub-project 1 energy simulations.

4.1.1.2 Laboratory Tests

The first TPR summarizes the results of the sub-project 1 component laboratory testing.

4.1.1.3 Commissioning Tests

The first TPR summarizes the results of the sub-project 1 commissioning tests

4.1.1.4 Field Experiments

4.1.1.4.1 *Field Experiment 1A: Impact of Integrated Demand Side Management Measures on Home and Grid*

The objective of this experiment is to quantify the impact of energy efficiency upgrades and DR strategies on the home and electric grid. This experiment includes four blocks of project homes. Three blocks received a series of IDSM measures through retrofits. Of these, the *ZNE Block* homes received the most extensive set of upgrades. Although the specific measures vary by home, most of the retrofits included LED lighting, heat pumps, a high-efficiency water heater or a domestic solar hot water heater, plug load timers, low-flow showerheads, duct sealant, increased attic insulation, ENERGY STAR smart appliances, solar PV arrays, RESUs, EVSEs, and other HAN devices. The *RESU Block* homes received RESUs, ENERGY STAR smart appliances, and EVSEs, but no other energy efficiency upgrades. The *CES Block* homes received the same equipment as the RESU homes, except that rather than receiving a RESU, the team installed a CES near the transformer to help manage load on the block's distribution transformer. The CES may also provide a limited amount of backup power in the event of an outage. The *Control Block* homes received no upgrades. The team assigned random numbers to each project home in order to conceal confidential customer information. For example, the nine homes on the ZNE Block are identified as homes ZNE 1 through ZNE 9.

The team installed power monitoring instrumentation in each home to help evaluate their performance. These monitoring devices consist of branch circuit monitors, plug load monitors, temperature sensors, and project smart meters. Transformer monitors record the loading on each of the four distribution transformers. A more detailed discussion of the team's approach for collecting this data is included in Appendix 3. This instrumentation provides detailed visibility of the project homes' energy consumption patterns, allowing the team to compare energy usage for particular types of load—such as lighting or refrigeration—between individual homes and across blocks. While no monitoring instrumentation was installed to capture natural gas usage, natural gas utility data was collected from the local gas utility (with the customers' consent) for 36 months starting on November 2011.

The Final Technical Report will include a more comprehensive analysis of this data. The intent of this second TPR is to evaluate the homes' overall progress toward achieving ZNE, and to provide some observations about the potential differences between the homes' initial ZNE targets and their interim results. The following are a few preliminary observations from this second phase of the demonstration period.

- Variability
 - There is a high degree of variation in energy use among the homes and between the four blocks. In the past 12 months, the electricity consumption of the homes ranged from about 3,000 kWh (ZNE 3) to nearly 11,000 kWh (RESU 1), while homes in the Control Block consumed up to 15,000 kWh (CTL 5). Natural gas consumption also varied significantly among the homes and between the blocks. ZNE 6 consumed 10,000 thousand British thermal units (kBtu), while RESU 6 consumed over 70,000 kBtu. Control Block homes consumed much as 85,000 kBtu (CTL 8).
 - There is also a high degree of energy use variation among individual appliances within each home. Lighting, HVAC, and refrigeration typically represent the most energy use for the ZNE Block homes, although there are exceptions. ZNE 4's television energy use is comparable to its HVAC and refrigerator energy use combined, while ZNE 1's television energy use is nearly zero. ZNE 2's home office equipment energy use is comparable to its HVAC energy use.
 - HVAC energy use varied considerably among the homes and between the blocks. Most of the ZNE Block homes received electric heat pumps in exchange for their existing air conditioners and gas furnaces—or just the gas furnace for homes without air conditioning units. The HVAC energy use of the ZNE Block homes varied significantly. ZNE 9 used six times more energy than ZNE 8 to run its HVAC. CES 1 used 18 times more energy than CES 6 to run its HVAC. And RESU 5 used twice as much energy as RESU 6 to run its HVAC.
- Electric Vehicle Chargers
 - Typically, PEV charging is among the top four energy uses for the ZNE, CES, and RESU block homes. CES 7's PEV charging represents its largest source of energy use.
- Achieving ZNE Status
 - Achieving ZNE status is highly dependent on the metric used to evaluate ZNE. As a result, some homes have achieved ZNE status under one of the metrics, but did not achieve ZNE under other metrics.

- Comparing the initial predicted ZNE status of the ZNE Block homes with their actual ZNE status shows that, on average, the homes on the ZNE Block are nearly 50% below what the team originally predicted. While multiple factors influenced the difference between the predicted and the actual ZNE status, the team believes there are three primary reasons for the difference. First, there were a few differences between the assumptions used for the eQUEST simulations and what the team implemented in the homes. For example, the eQUEST simulations assumed slightly larger solar PV arrays than what was installed (4.05 kW v. 3.9 kW). In addition, the solar domestic hot water systems were 25% to 50% smaller than what was modeled in eQUEST. The second major factor was that each home received a RESU, which was not included in the original eQUEST simulations. Using a RESU to store energy (either from the rooftop solar PV or grid power), results in a loss of 20% or more of the stored energy due to efficiency losses and auxiliary RESU loads. Finally, the team believes that changes in occupant behavior also contributed to the homes' ZNE performance. Such changes might occur due to changes in weather, occupancy, or other factors. It is also possible that behavior changes could result from the occupants' perception that they are receiving free energy from the solar PV arrays. The Final Technical Report will provide a more detailed analysis of the differences between the eQUEST model and the actual ZNE performance of the ISGD homes.

Impact on the Homes

Figure 13 through **Figure 16** summarize one year of continuous electricity usage between November 1, 2013 and October 31, 2014, for each project home. These figures are organized by project block. The figures illustrate the level of detailed data the team is collecting to assess the impacts of the various energy efficiency components. For example, energy consumption for lighting is available for all the blocks, excluding the Control Block. Although the ZNE Block received high efficiency LED lighting upgrades, lighting is still a major source of energy usage within these homes. "Other Loads" consists of electricity use that the Team does not monitor discretely. This likely includes devices plugged into wall outlets such as laptop computers, routers, cable boxes, floor lamps, microwave ovens, etc.

Figure 13: ZNE Block Electric Energy Use Breakdown (November 1, 2013 to October 31, 2014)

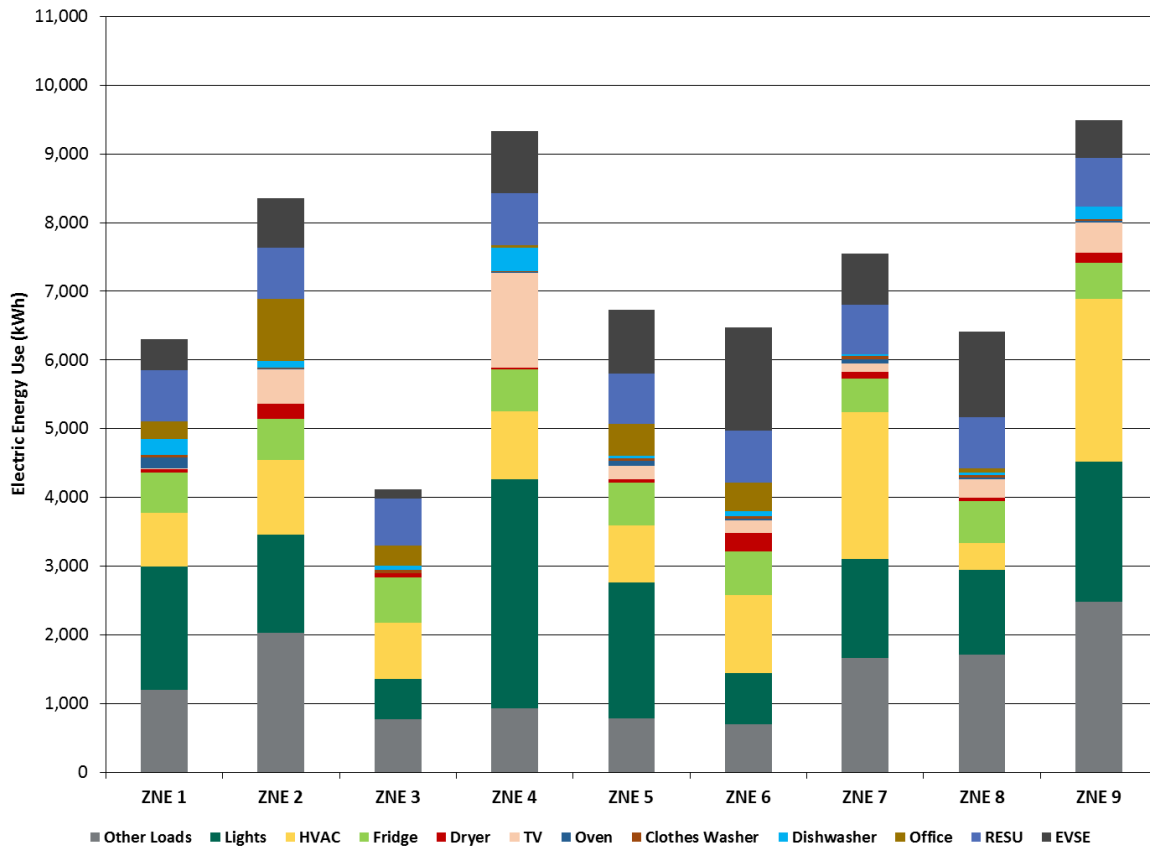

Figure 13 shows the electric energy usage breakdown of the homes on the ZNE Block. In general, lighting and HVAC represent the top two energy consuming components followed by the refrigerator and television. Occupant behavior clearly affects the energy usage of these homes. The impact of occupant behavior can be seen in ZNE 4, where the large television energy usage is the same as the HVAC and refrigerator combined. This impact can also be seen in ZNE 2, where the home office equipment energy usage is comparable to its HVAC energy usage. In ZNE 6, the relatively large clothes dryer energy usage results from the dryer being an electric unit. In ZNE 6, the electric vehicle charging represents a significant share of total home energy. This home consumes nearly 50% more EVSE use than most of the other homes on the ZNE Block.

Figure 14: RESU Block Electric Energy Use Breakdown (November 1, 2013 to October 31, 2014)

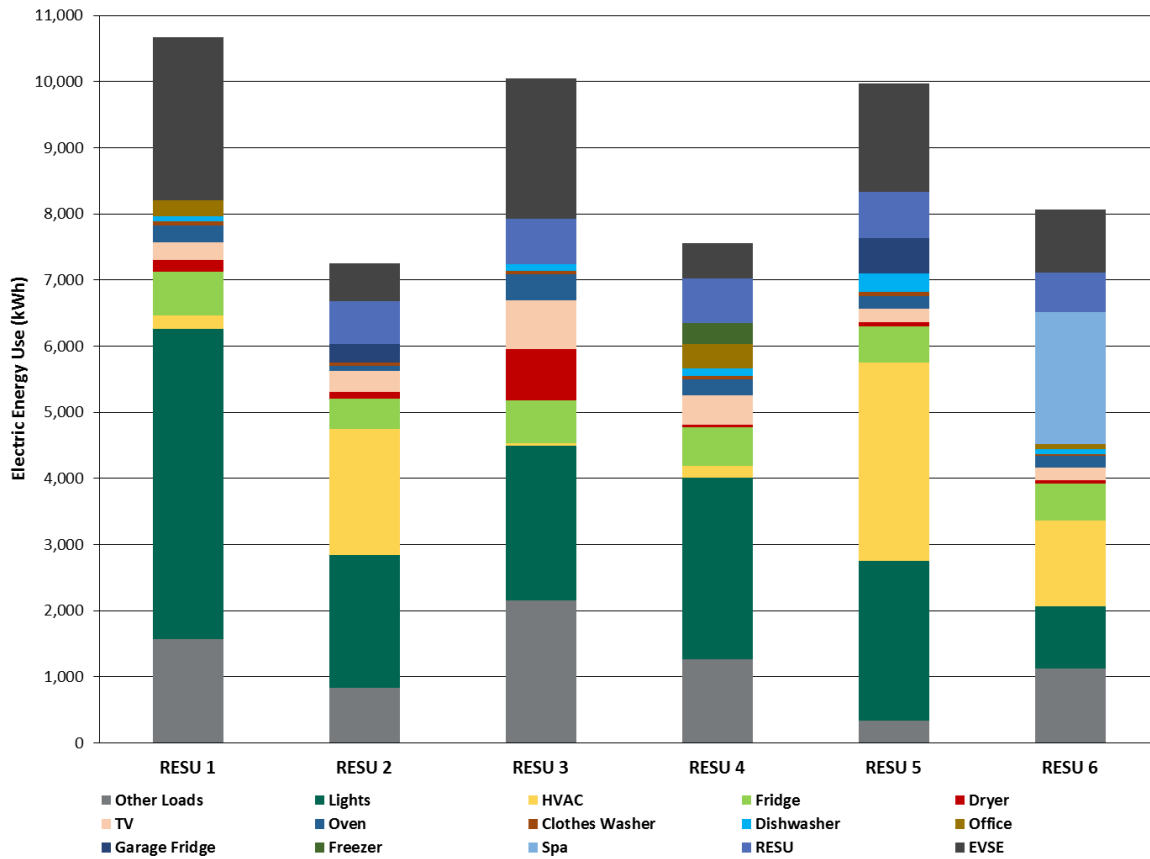

Figure 14 summarizes the energy use breakdown for each RESU Block home. The top two energy-use components are lighting and HVAC, which is consistent with the ZNE Block homes. The next two largest energy use components are the refrigerator and television. It is worth noting that the HVAC energy usage of RESU 1, RESU 3, and RESU 4 are much lower than their television energy usage. These homes use natural gas furnaces for heating rather than heat pumps. In addition, RESU 3 has very high clothes dryer energy use, which is mostly the result of having an electric dryer. RESU 6 is the only ISGD home with a spa, which represents nearly 30% of the home’s total energy use. The electric vehicle charging represents a significant share of total home energy usage, with RESU 1, RESU 3, and RESU 5 consuming nearly twice as much as the other RESU Block homes.

Figure 15: CES Block Electric Energy Use Breakdown (November 1, 2013 to October 31, 2014)

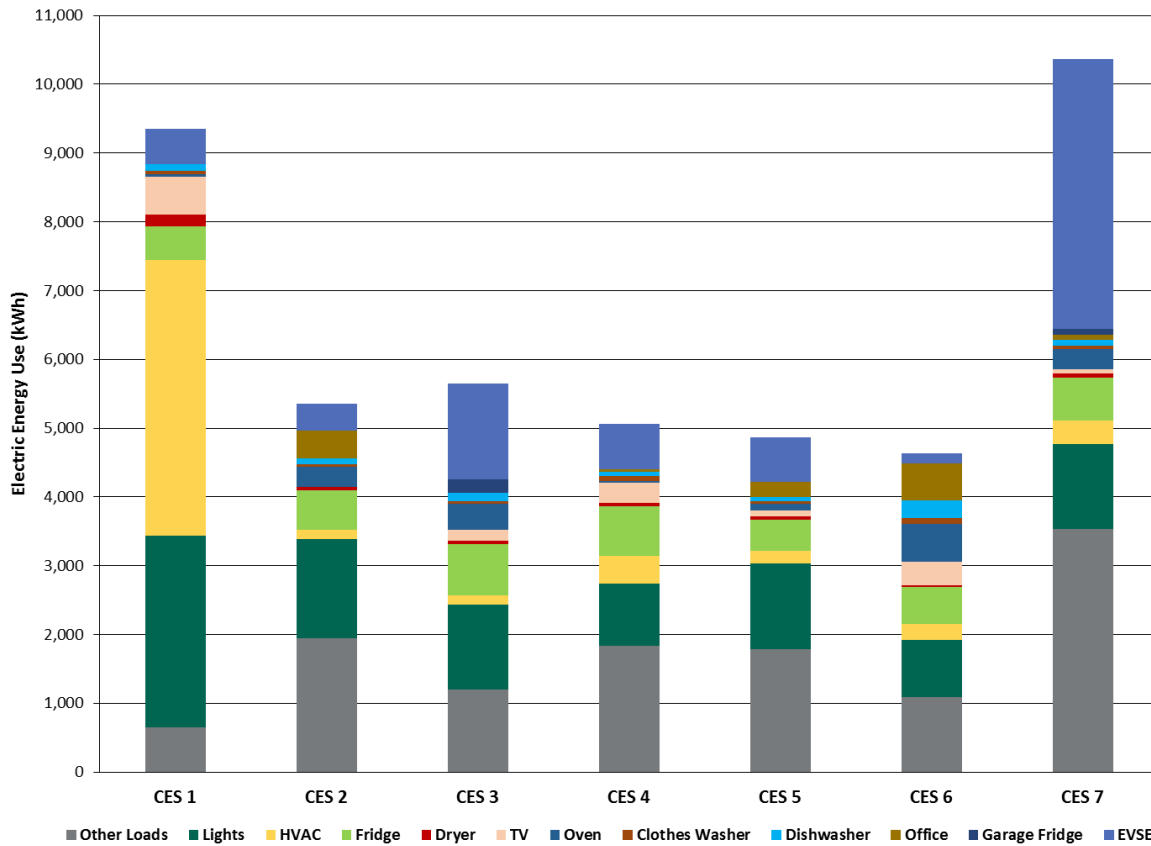

Figure 15 summarizes the electric energy usage breakdown of the CES Block homes. The components with the highest energy use are lighting and the refrigerator, followed by HVAC and television. The largest variability is between CES 1 and CES 7. The HVAC energy usage of CES 1 is nearly half of the home total energy use and 10 to 18 times greater than CES 4, CES 6, and CES 7 (CES 2, CES 3, and CES 5 only have natural gas furnaces for home heating). Electric vehicle charging represents almost 40% of CES 7's total energy consumption, and uses approximately 10 times more energy than any other home in the CES Block. In these two cases, occupant behavior is the main cause of the large variability. The team confirmed with the residents of CES 1 their high HVAC energy use from late spring to early fall of 2014. CES 7's high EVSE energy use is a result of this home having up to three PEVs throughout the second TPR period.

Figure 16: Control Block Electric Energy Use Breakdown (November 1, 2013 to October 31, 2014)

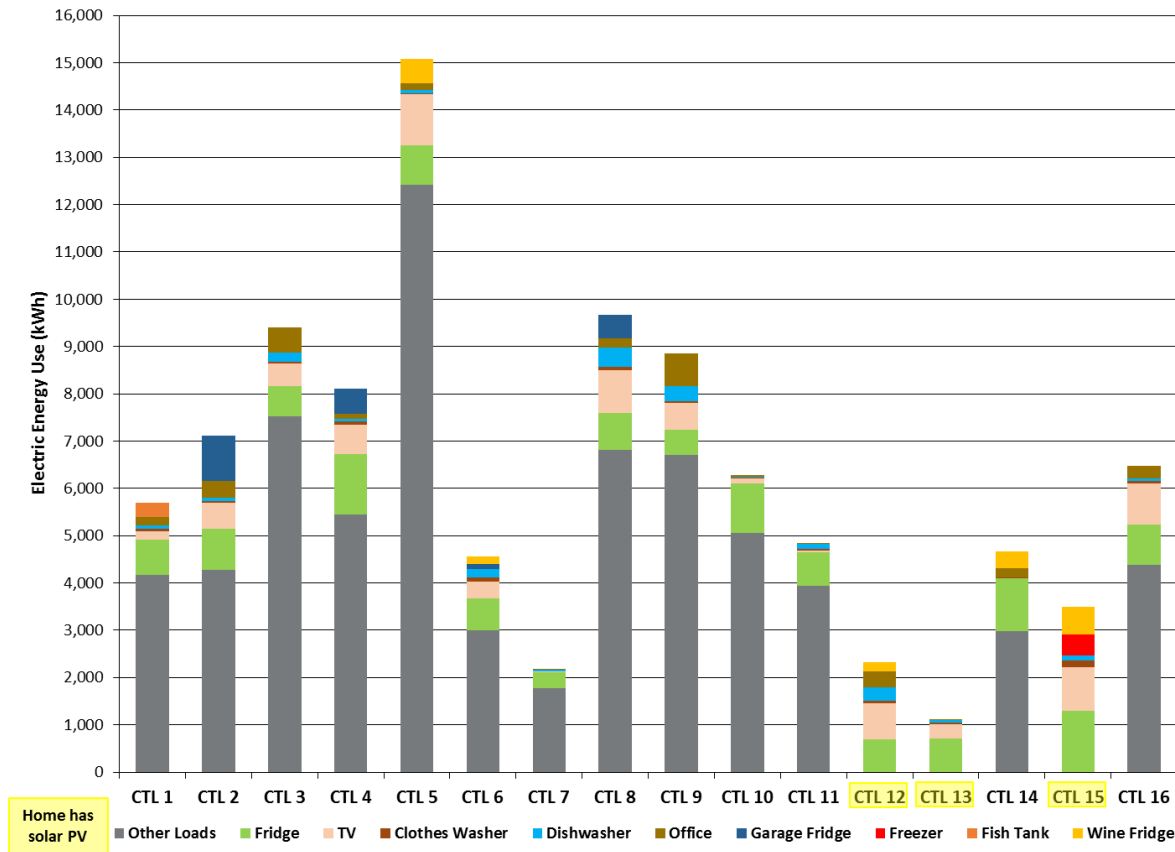

Figure 16 displays some of the electric loads for the Control Block homes. Other Loads represents the largest load in all the homes, excluding CTL 12, CTL 13, and CTL 15, which have solar PV arrays. The team did not equip these homes with the same level of energy usage monitoring equipment as the other project block homes. As such, the Other Loads are determined by subtracting the various monitored loads from the whole-house meter data. In the case of the homes with solar PV arrays, it was not possible to calculate the Other Loads because the solar PV generation was not measured. Still, refrigerator and television are significant loads in these homes, consistent with the ZNE, RESU, and CES blocks.

The natural gas usage for 36 months ending on October 31, 2014 is summarized in **Figure 17** through **Figure 20**. The natural gas data was only available at the utility meter level and was reallocated to fall within monthly calendar periods. These figures are organized by project block and three 12-month periods. The first period covers November 1, 2011 to October 31, 2012, which is before the homes received any energy efficiency upgrades. The second period covers November 1, 2012 to October 31, 2013, which is when most energy efficiency upgrades were being performed. The third period covers November 1, 2013 to October 31, 2014, which represents the period of analysis for this second TPR. The focus of this analysis is to compare the natural gas usage during the second TPR period (November 1, 2013 to October 31, 2014) with the previous two periods.

Figure 17: ZNE Block Natural Gas Energy Use (November 1, 2011 to October 31, 2014)

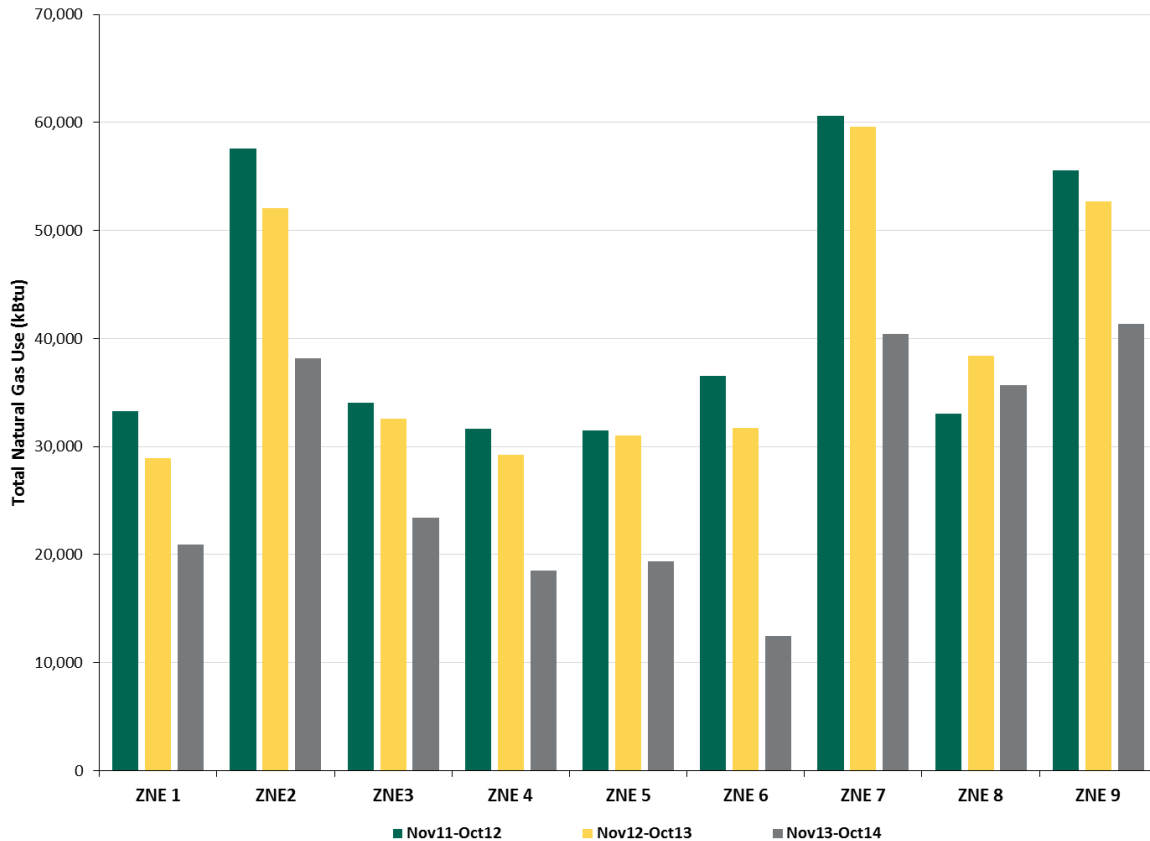

Figure 17 summarizes the natural gas consumption for the ZNE Block homes. In general, natural gas use declined between November 2011 and October 2014 by an average of 30%, across all ZNE Block homes, with two exceptions. ZNE 6’s natural gas consumption declined by over 60% compared to the two previous periods (Nov ‘11-Oct ‘12 and Nov ‘12-Oct ‘13), and ZNE 8’s consumption has not changed over the past 36 months. The team speculates that ZNE 6 occupant behavior contributed significantly to their reduced natural gas use, in addition to the energy efficiency measures affecting natural gas usage, such as a solar domestic hot water (DHW) system. The residents maintain the hot water tank at a lukewarm temperature to avoid having hot water with small children in the house. ZNE 8 had an equipment malfunction with their solar DHW system that the residents did not notice until late 2014. The general decline in natural gas use was consistent across all four blocks, including the Control Block.

Figure 18: RESU Block Natural Gas Energy Use (November 1, 2011 to October 31, 2014)

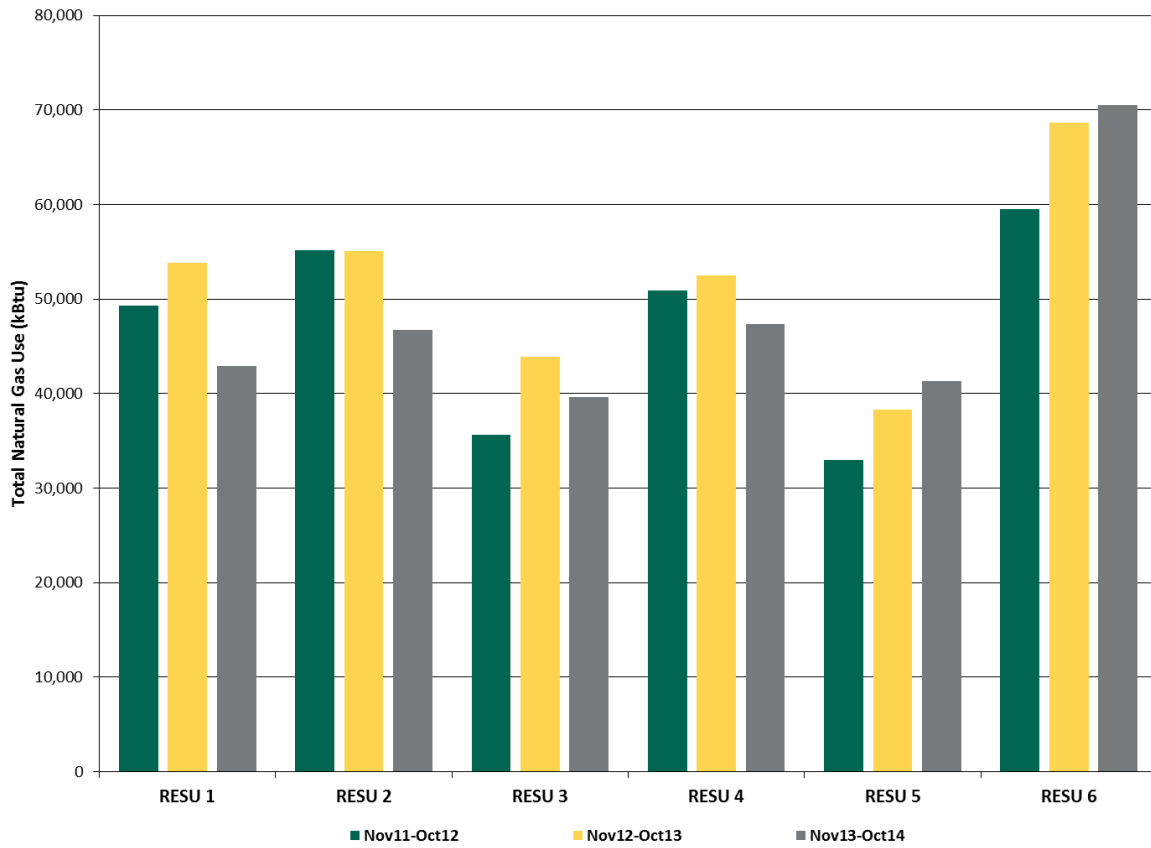

Figure 18 summarizes the natural gas consumption for the RESU Block homes. The only energy efficiency upgrade that these homes received that affects natural gas consumption is ENERGY STAR clothes washers. Over the 36 months, the natural gas consumption of RESU 1, RESU 2, and RESU 4 declined by about 10%-15%, while RESU 3 was practically unchanged. The natural gas consumption of RESU 5 and RESU 6 increased by 10%-15%.

Figure 19: CES Block Natural Gas Energy Use (November 1, 2011 to October 31, 2014)

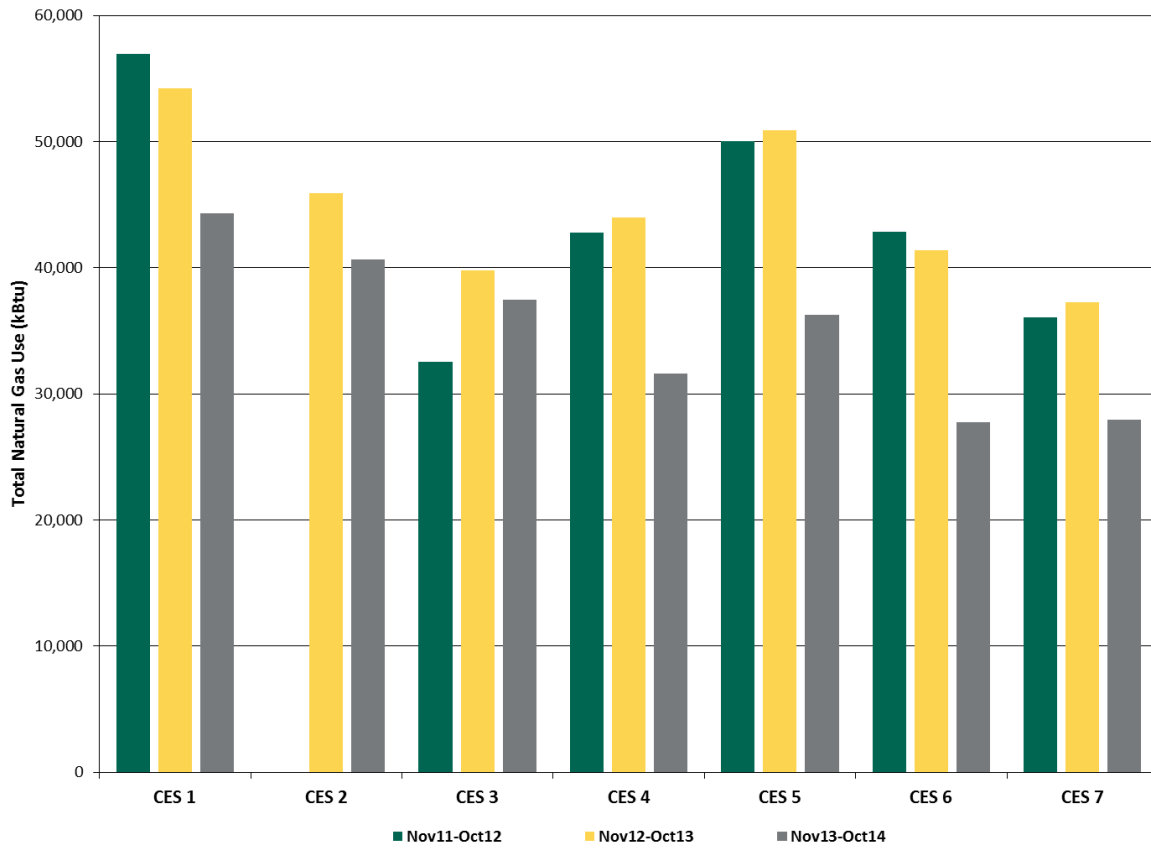

Figure 19 summarizes the natural gas consumption for the CES Block homes from November 2011 to October 2014. Similar to the RESU Block homes, the only energy efficiency upgrade that these homes received that affects natural gas consumption is ENERGY STAR clothes washers. In general, natural gas consumption declined by 20%-30% across all homes in the CES Block, with the exception of CES 3, which remained nearly unchanged over the 36-month period. This figure excludes the CES 2 data for November 2011 to October 2012 because the current occupants moved into the home in August 2012.

Figure 20: Control Block Natural Gas Energy Use (November 1, 2011 to October 31, 2014)

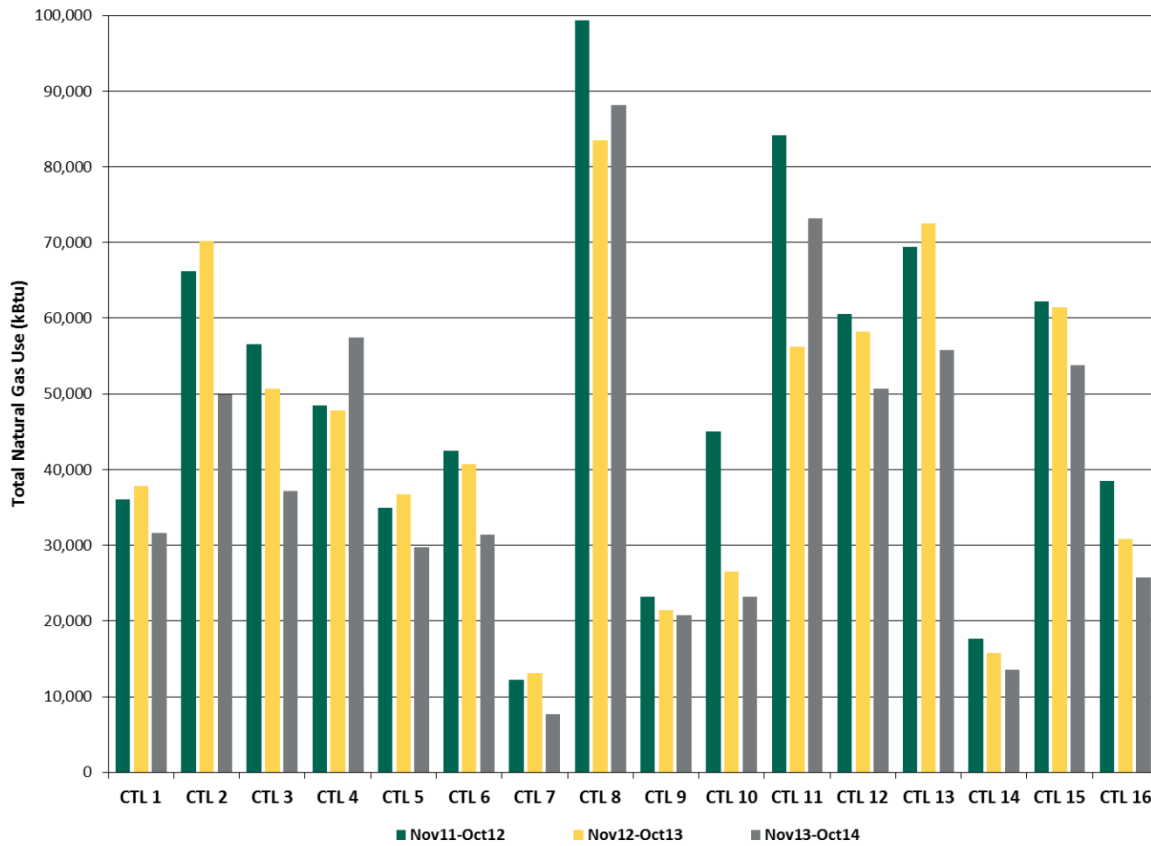

Figure 20 displays the natural gas consumption for the Control Block homes over a 36-month period. In general, natural gas consumption in all Control Block homes declined, with the exception of CTL 4. There is significant variation in natural gas consumption among the homes, with some consuming 10 times as much as other homes (e.g., CTL 8 versus CTL 7).

Impact on the Grid

Another aspect of this experiment is to evaluate the impact of the energy efficiency upgrades, DR strategies, solar PV, RESU, CES, and PEV charging on the grid. This consists of monitoring the load profiles of the four distribution transformers on the four blocks of project homes. **Figure 21** through **Figure 24** present the load profile of all nine homes on the ZNE Block for December 2013, March 2014, June 2014, and September 2014, respectively. The data in these figures represents the aggregate load for all nine homes (i.e., the load of the entire ZNE Block), averaged for all the days in the respective month. The yellow line represents the block’s total load (kW) (i.e., how much power all the homes required at various times throughout the day). The thick gray line represents the ZNE Block’s net demand (measured by the project smart meters in each home on the ZNE Block). The net demand is lower than total demand due to the solar PV generation, and the RESU charging and discharging activity (represented by the dotted line). The blue line indicates the demand from PEV charging, while the green line represents the solar PV generation.

Figure 21: ZNE Block Aggregate Home Load Profile (Daily Average for December 2013)

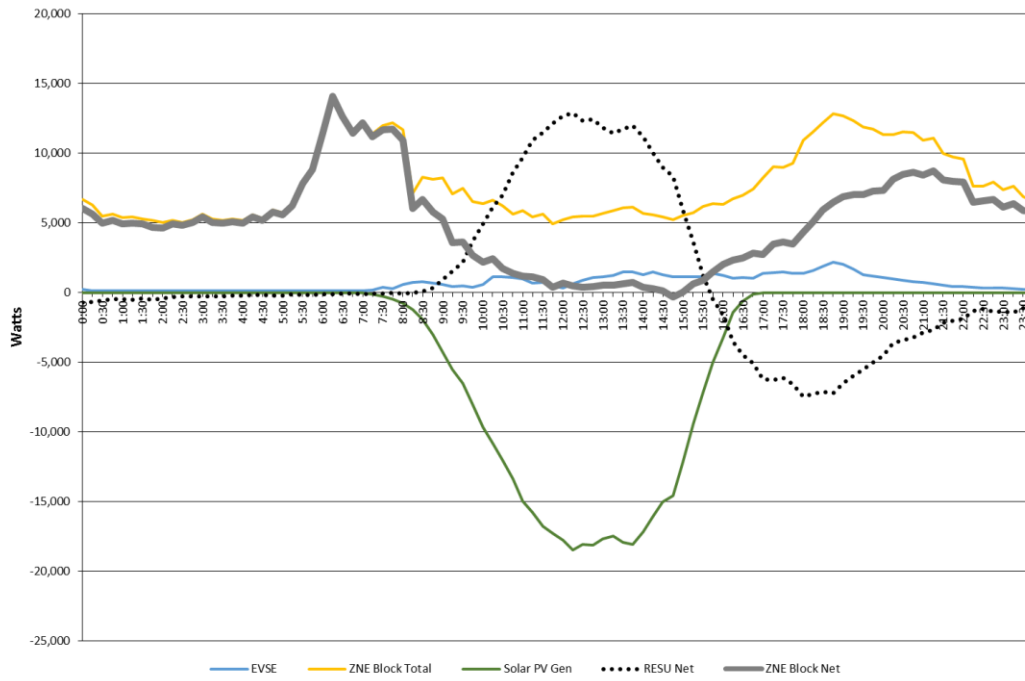

Figure 22: ZNE Block Aggregate Home Load Profile (Daily Average for March 2014)

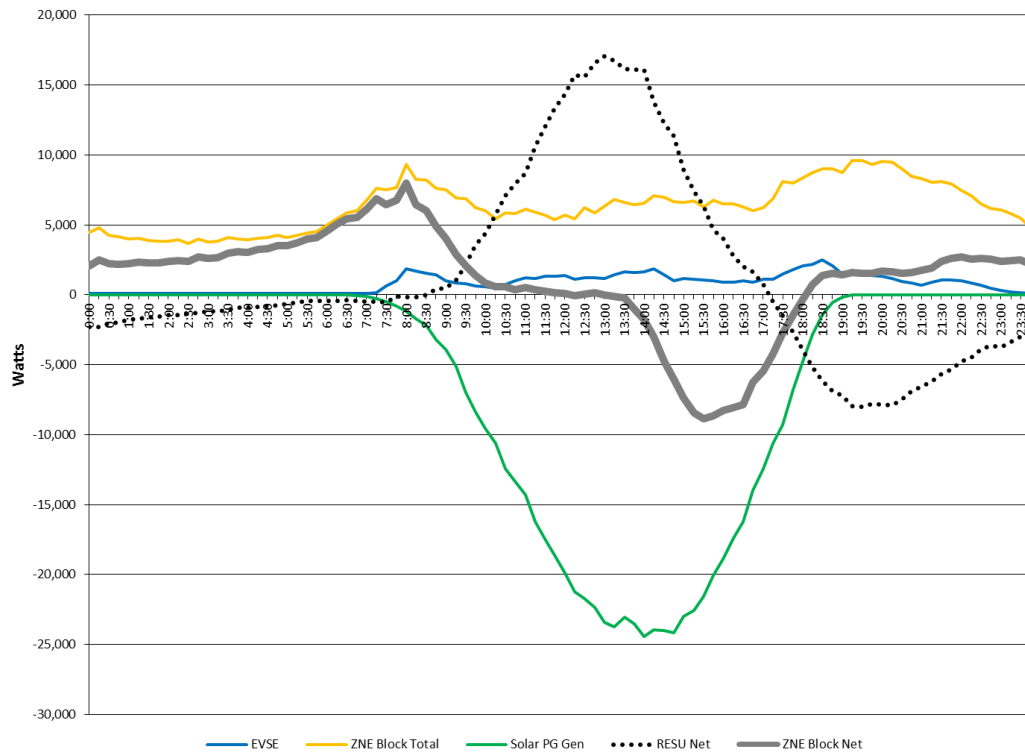

Figure 23: ZNE Block Aggregate Home Load Profile (Daily Average for June 2014)

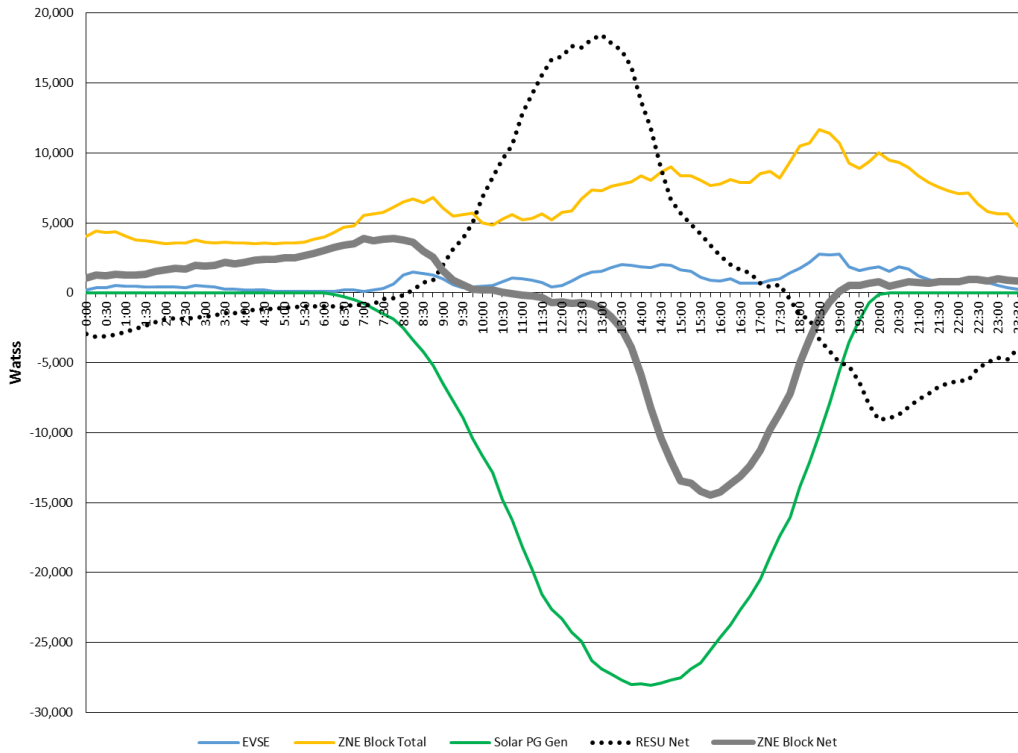
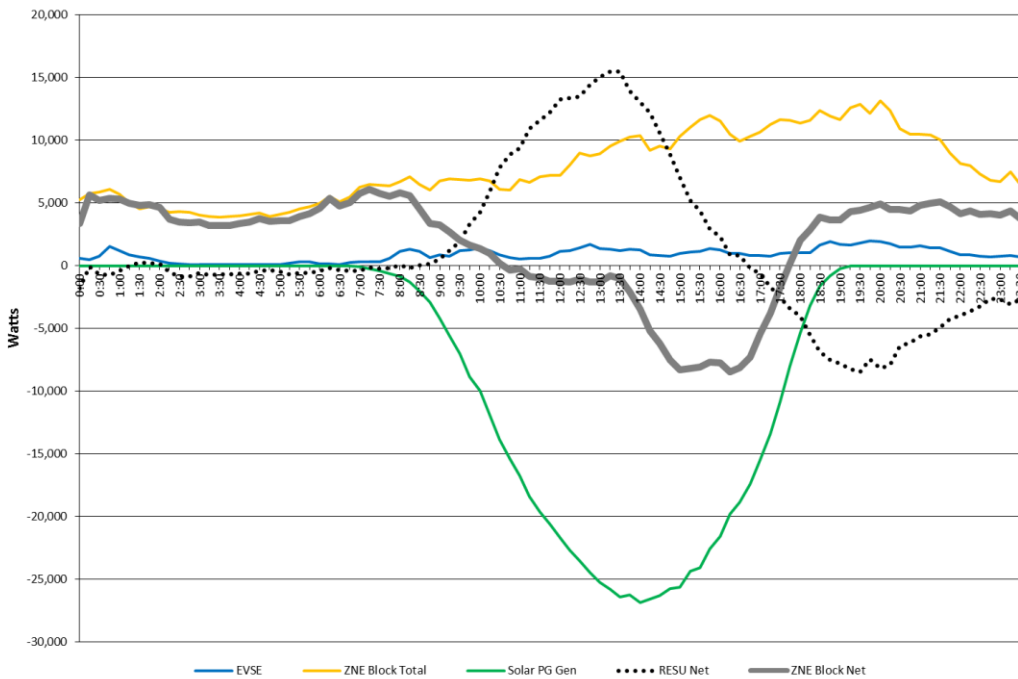

Figure 24: ZNE Block Aggregate Home Load Profile (Daily Average for September 2014)



During the second TPR period (November 1, 2013 through October 31, 2014), the RESUs operated in the PV Capture mode. When operating in this mode, a RESU will charge or discharge based on a set point for the net household demand. This set point was set at 0 kW. The RESUs charged anytime the net household demand was below zero (e.g., the solar PV generation was greater than the home's electricity demand). The RESUs also discharged any time the net household demand was above zero. Naturally, the RESUs were constrained by their energy storage capacity (10 kWh), and could only discharge if there was energy in the RESU.

The solar PV generation exhibits seasonal fluctuations throughout the year. The solar PV output—for the entire ZNE Block—increases from nearly 20,000 W in December to about 25,000 W in March. It then increases to about 30,000 W in June before dropping to about 25,000 W in September. This variation in solar PV generation impacts the load shapes throughout the year. In December, the ZNE Block net demand remains near zero during the peak solar hours, then increases to about 8,000 W during the peak evening load period (see **Figure 21**). The load is near zero during the daytime since the RESU was operating in Level Demand mode.¹⁵ In March, the ZNE Block net demand goes from negative (about -10,000 W) during the solar peak hour to positive evening demand of around 2,500 W (see **Figure 22**). In June, the ZNE Block net demand also goes from about zero during the early morning to about -15,000 W during the solar peak hours, and then returns to zero in the evening hours (see **Figure 23**). This near zero demand during the evening is due to the RESUs offsetting most of the homes' loads. During September, the ZNE Block net demand is similar to March, except that it has higher evening demand of about 5,000 W (see **Figure 24**). The combination of solar PV generation and RESU charging and discharging has a significant impact on the demand level throughout the day.

Unlike the ZNE Block, in which all homes on the block are project participants, not all the homes on the RESU and CES blocks are project participants. To evaluate the grid impact of the RESU and CES block homes-- and to be able to compare their impact with the homes in the ZNE Block—the team used an average home load profile for the ZNE, RESU, and CES blocks. **Figure 25** through **Figure 27** show the average home profiles for the three blocks during December 2013. These load profiles consist of an average of the 31 days in December. The yellow line represents the average home's total load (kW) (i.e., how much power the average home required throughout the day). The thick gray line represents the net demand of the average home. The net demand is lower than total demand due to the solar PV generation, and the RESU charging and discharging activity (represented by the dotted line). The blue line represents PEV charging and the green line represents the solar PV generation.

¹⁵ The RESU Level Demand experiment was documented in the first TPR. When operating in this mode, the RESU attempts to decrease a home's maximum demand and increase its minimum demand through charging and discharging. The goal of this mode is to "level" a home's demand throughout the day by removing the peaks and valleys in the home's load profile.

Figure 25: ZNE Block Average Home Load Profile (Daily Average for December 2013)

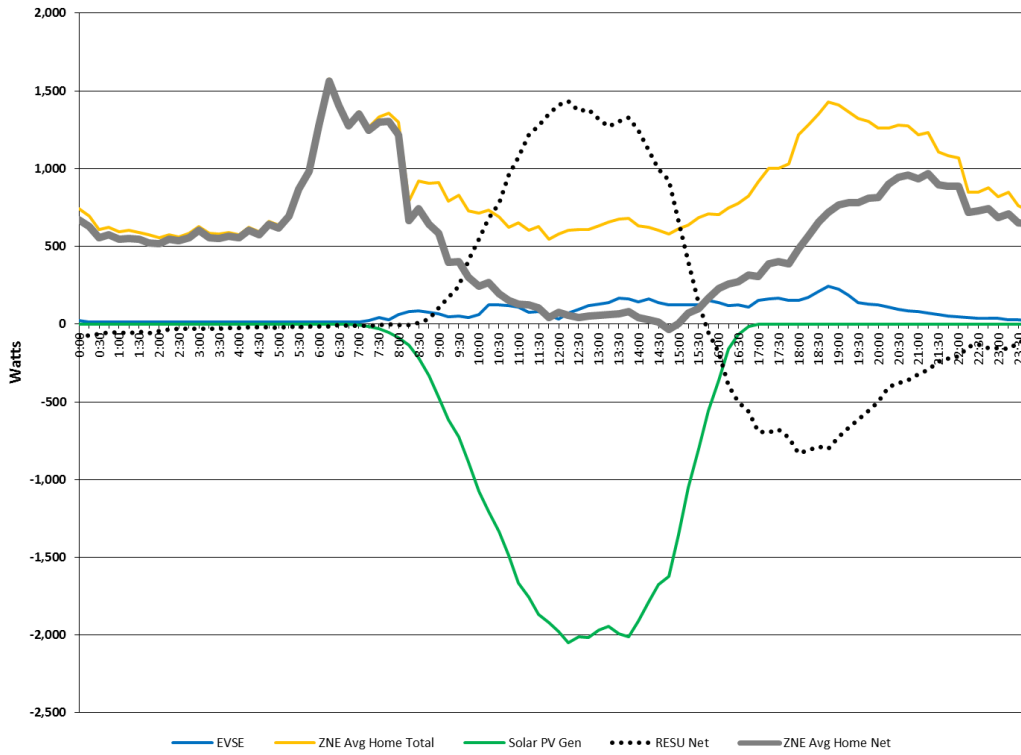

Figure 26: RESU Block Average Home Load Profile (Daily Average for December 2013)

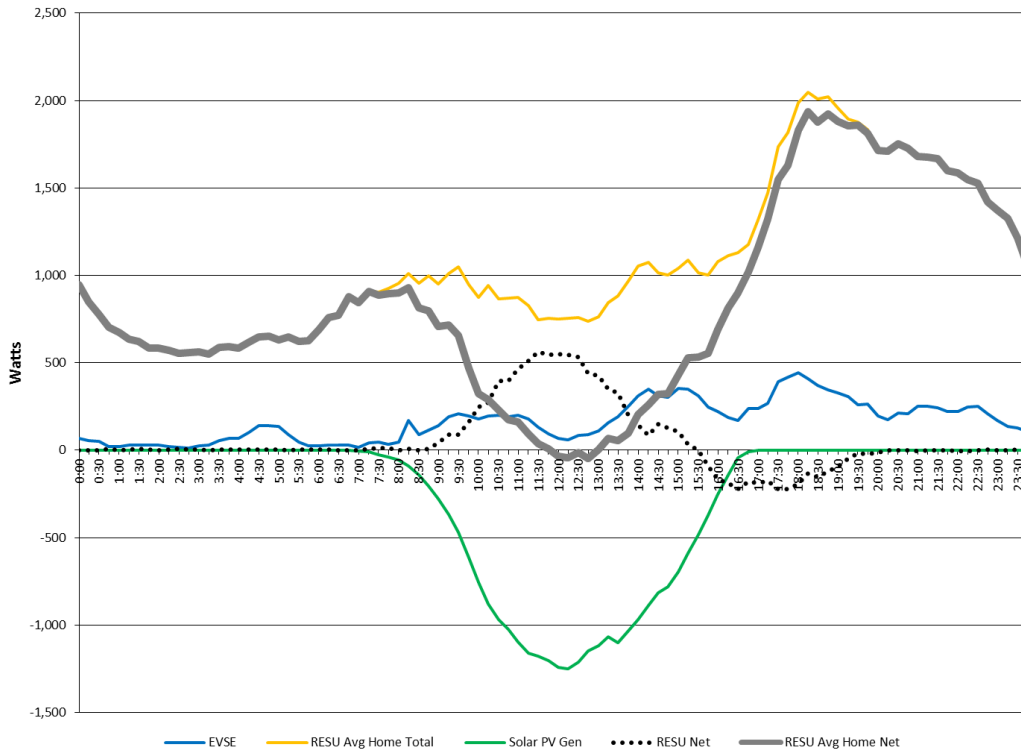

Figure 27: CES Block Average Home Load Profile (Daily Average for December 2013)

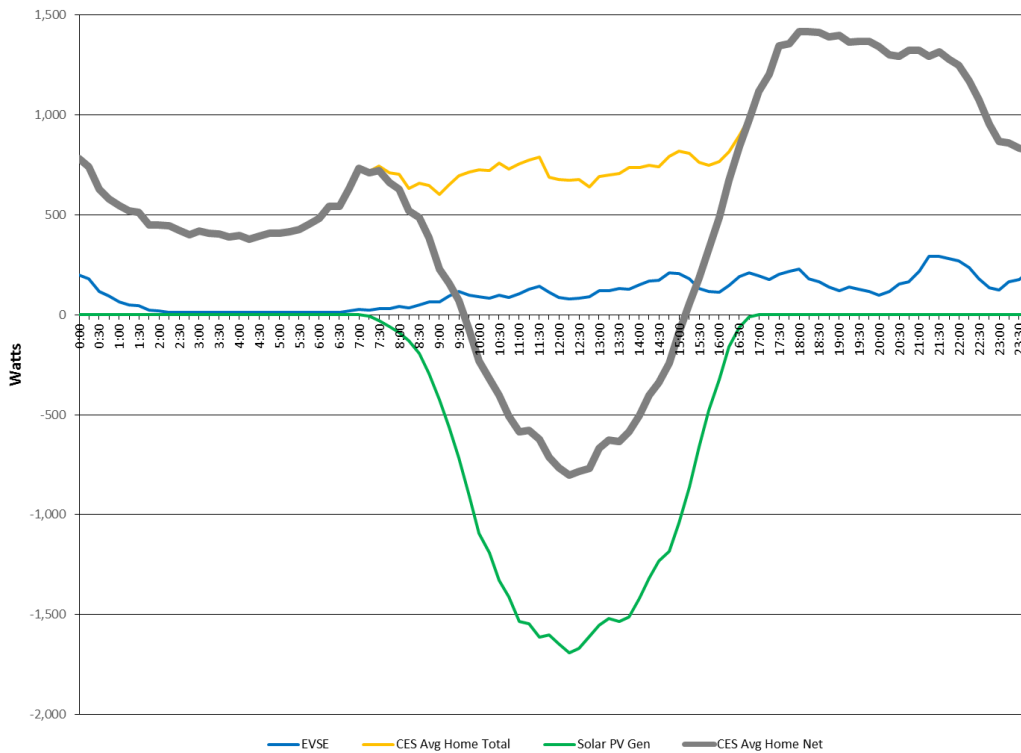

Figure 25 and **Figure 26** indicate a similar pattern between the average ZNE home and average RESU home for December 2013. The average ZNE home net demand goes from about zero (during the peak solar hours) to close to 1,000 W during the evening hours. The average RESU home reaches zero net demand for a few hours (during the peak solar period), and then increases to nearly twice the average ZNE home average net demand during the evening. The difference is a result of the ZNE homes’ energy efficiency measures and slightly larger solar PV arrays.

The average CES home has negative net demand during most of the peak solar hours (see **Figure 27**). Unlike the ZNE and RESU block homes, the CES block homes do not have RESUs to absorb the surplus solar PV output. During the evening hours, net demand is the same as the home total demand. Although the CES Block homes do not have RESUs, the CES Block has a CES device capable of producing the same effect as the RESUs when operating in permanent load shifting mode. Thus, the load profiles of the ZNE, RESU, and CES blocks distribution transformers are similar.

Figure 28 through **Figure 36** show the average home profile for the ZNE, RESU, and CES blocks during the months of March 2014, June 2014, and September 2014, respectively. The seasonal variation in the solar PV generation has a significant impact on these load profiles. This is evident in the substantial increase of the number of hours when net demand is near zero or negative during the spring and summer months.

Figure 28: ZNE Block Average Home Load Profile (Daily Average for March 2014)

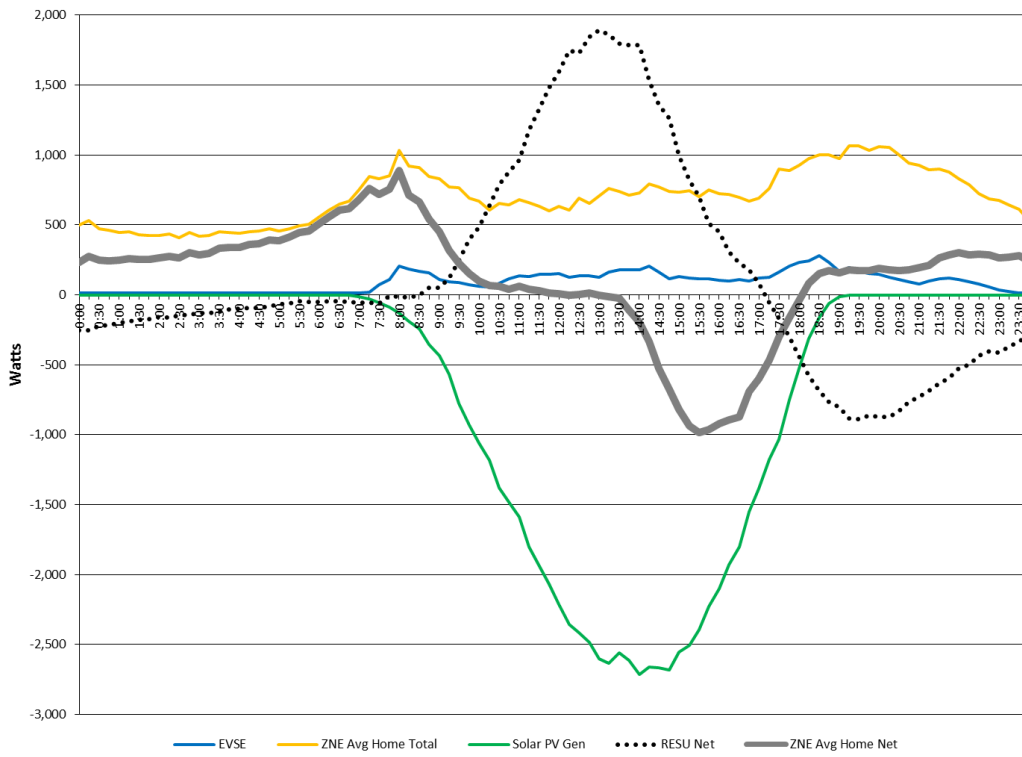

Figure 29: RESU Block Average Home Load Profile (Daily Average for March 2014)

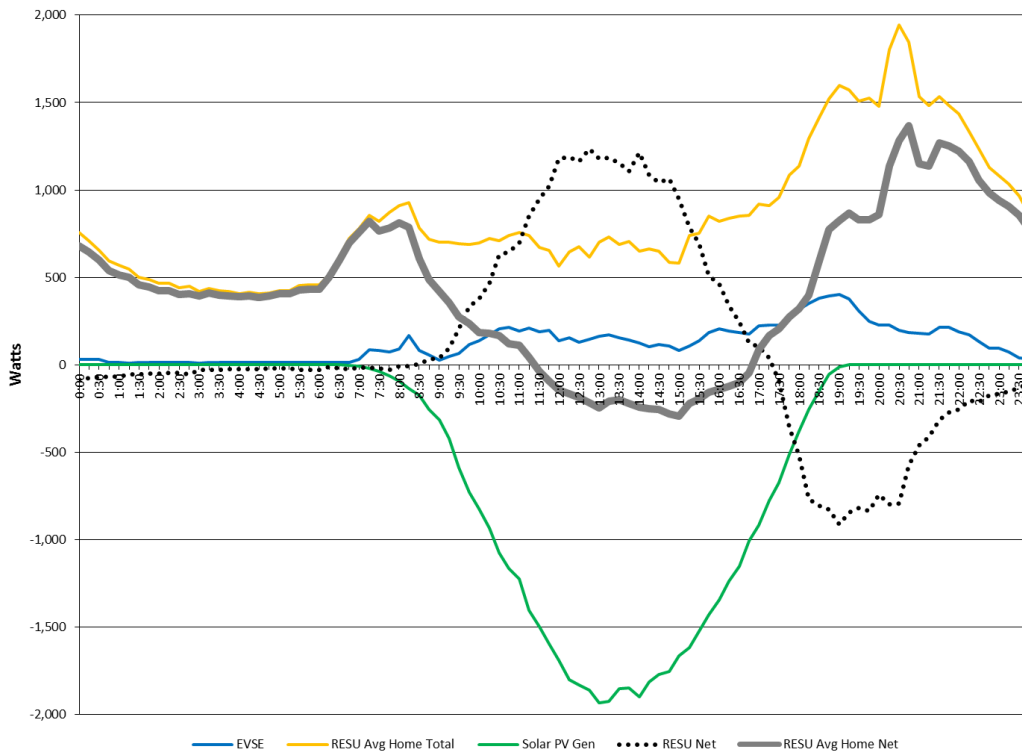

Figure 30: CES Block Average Home Load Profile (Daily Average for March 2014)

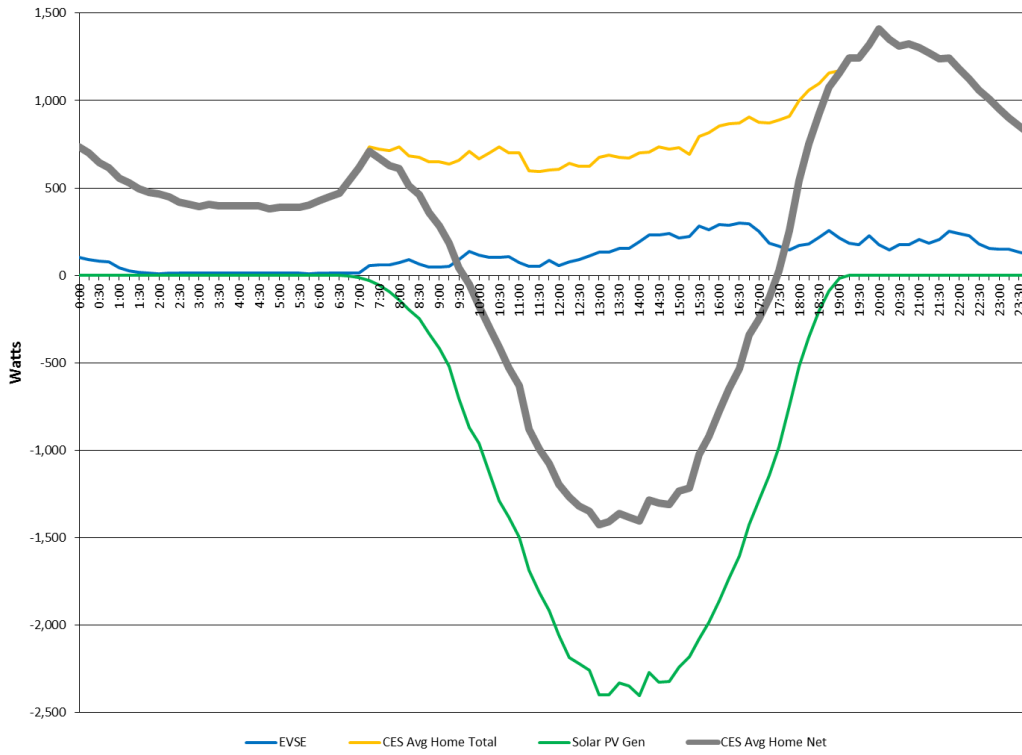

Figure 31: ZNE Block Average Home Load Profile (Daily Average for June 2014)

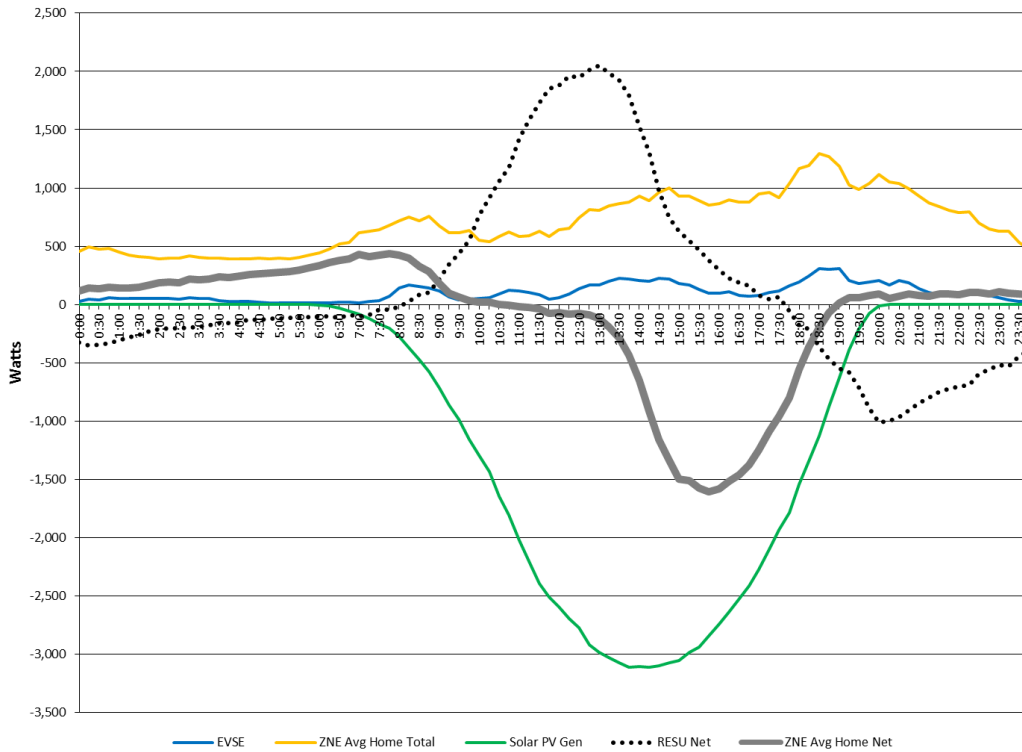

Figure 32: RESU Block Average Home Load Profile (Daily Average for June 2014)

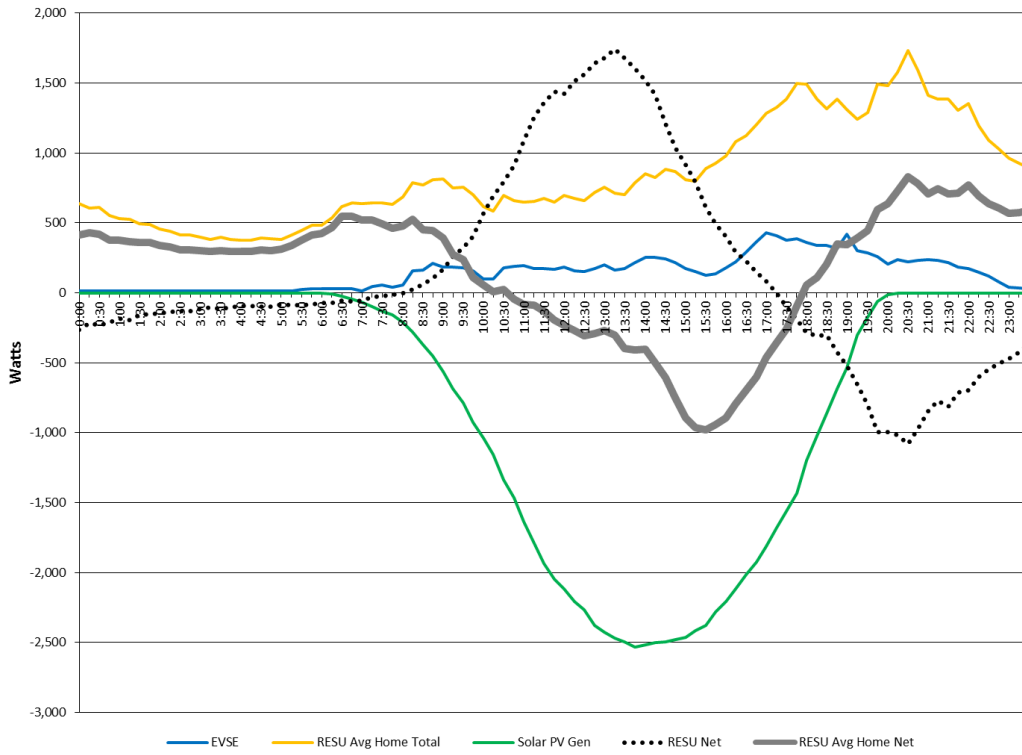

Figure 33: CES Block Average Home Load Profile (Daily Average for June 2014)

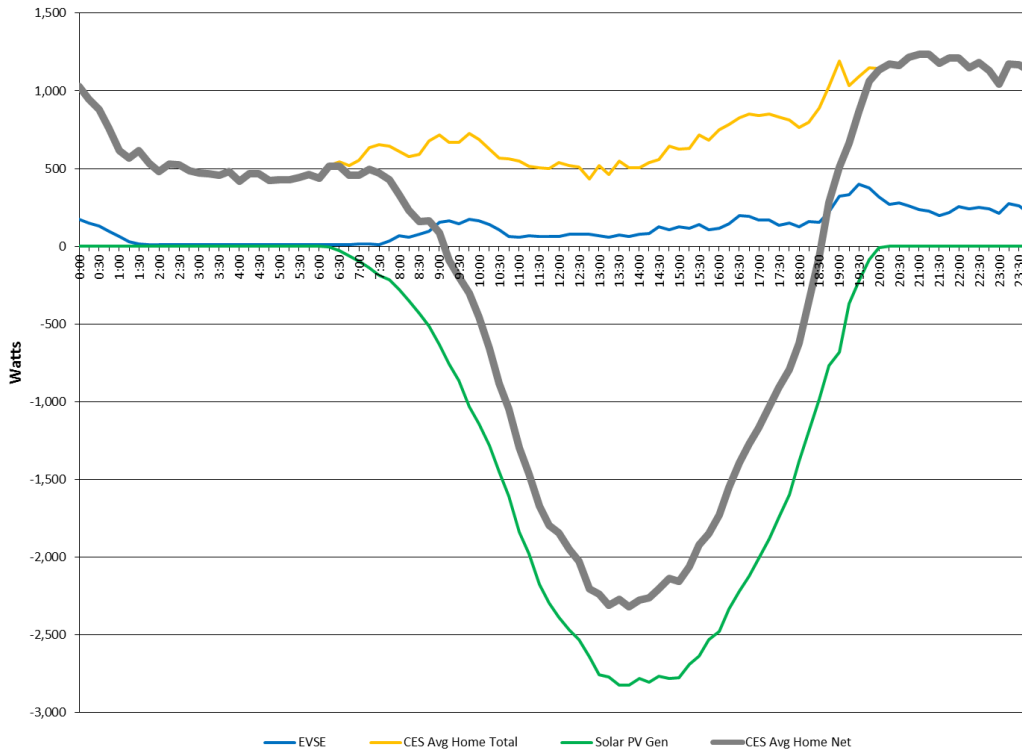

Figure 34: ZNE Block Average Home Load Profile (Daily Average for September 2014)

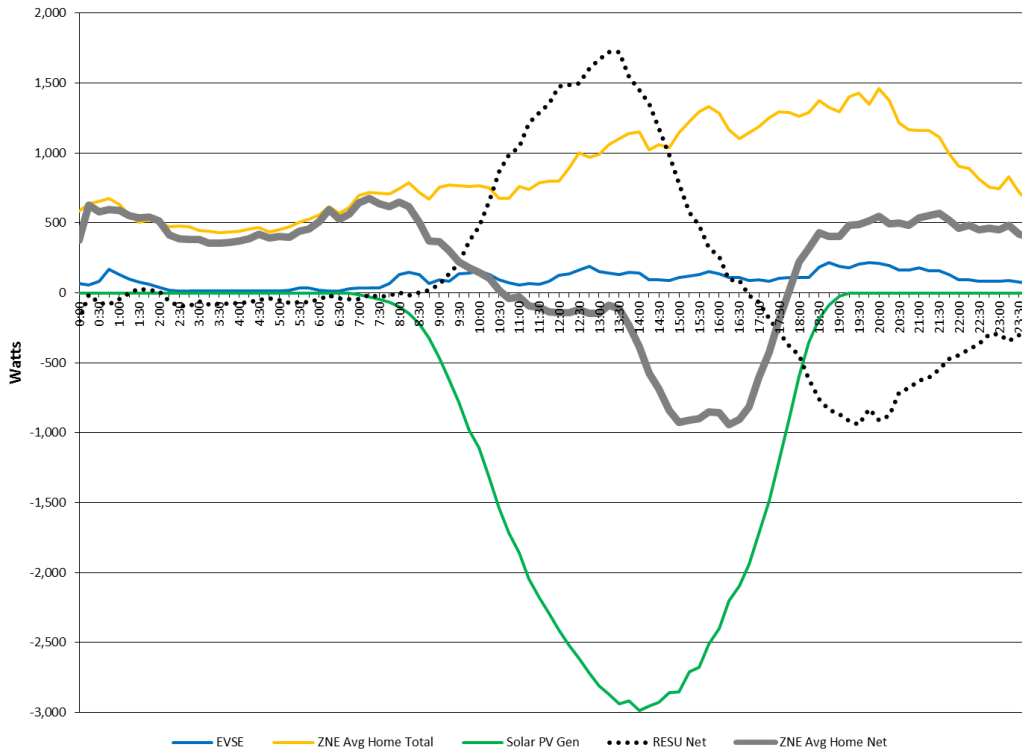

Figure 35: RESU Block Average Home Load Profile (Daily Average for September 2014)

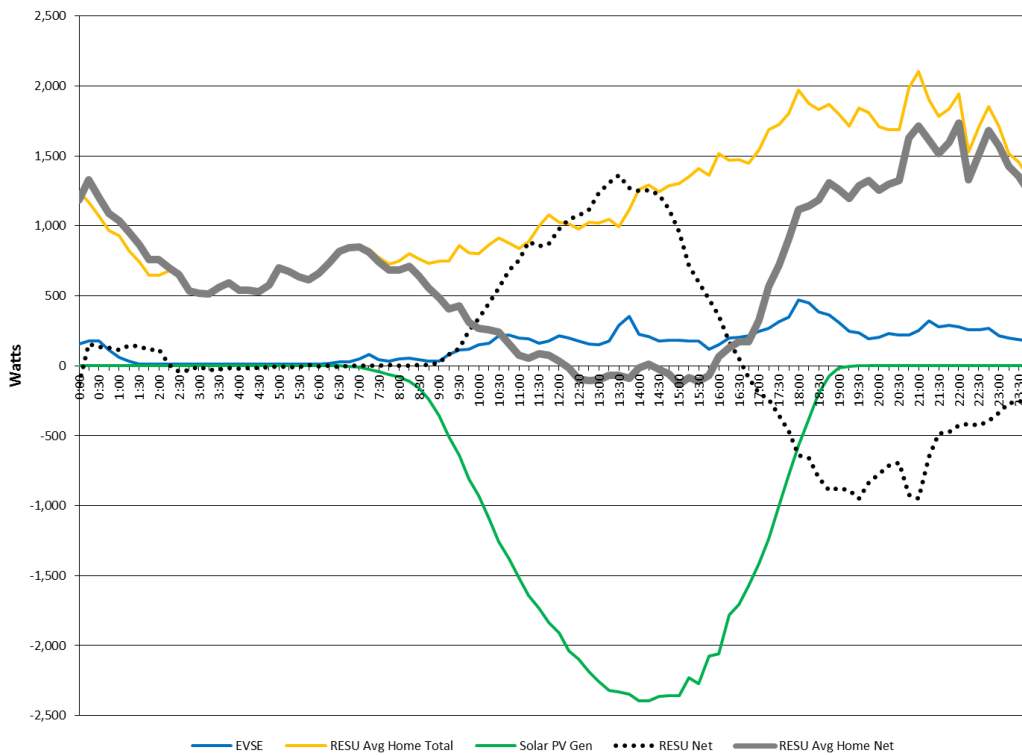
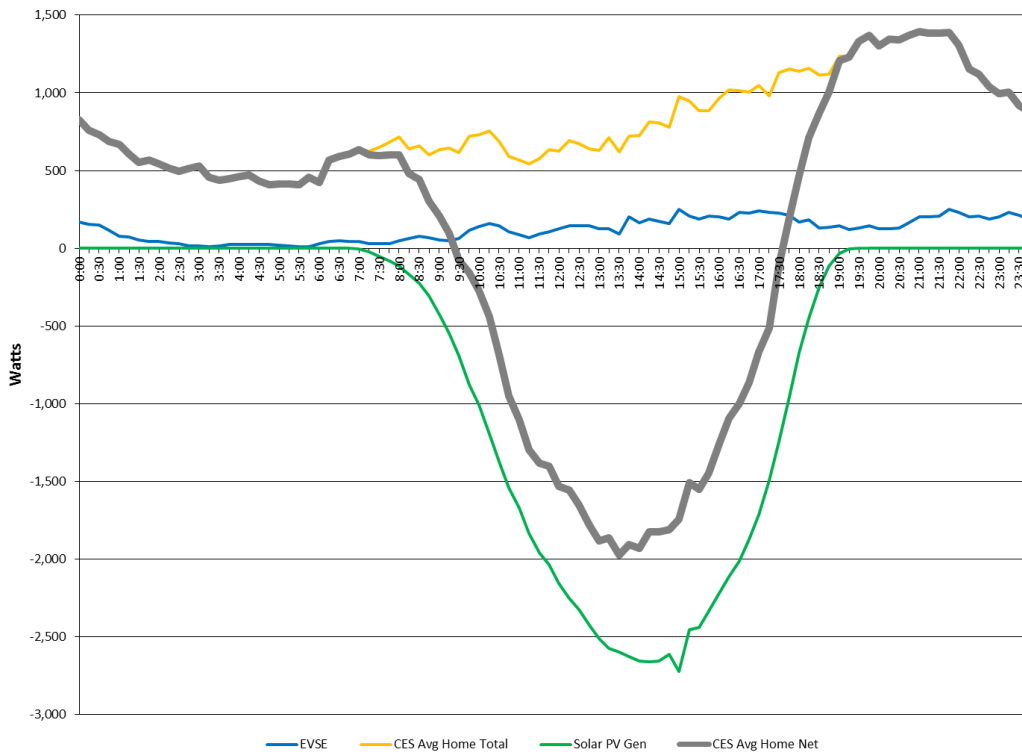
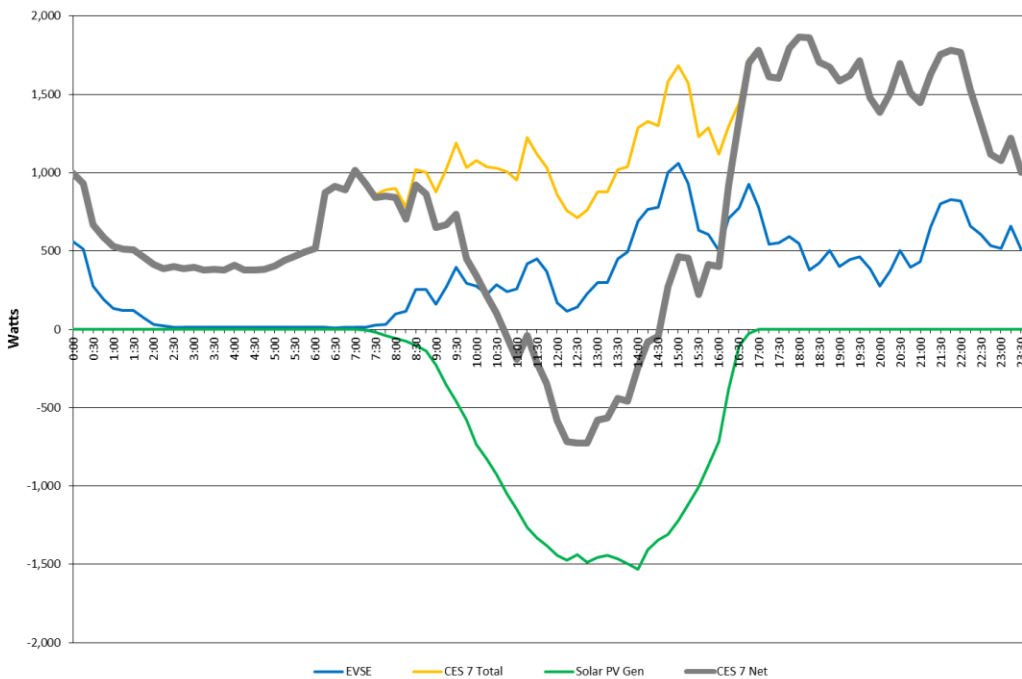

Figure 36: CES Block Average Home Load Profile (Daily Average for September 2014)



To illustrate the effect of the EVSEs on the total load and net demand profiles of the project homes, **Figure 37** presents the load profile of CES 7 for December 2013. The impact of PEV charging is evident throughout the day.

Figure 37: CES 7 Load Profiles (Daily Average for December 2013)



Reaching the ZNE Goal

Another key objective of sub-project 1 is to assess a suite of energy efficiency measures to help homes reach ZNE status. ZNE is defined as “the energy consumed by a home (building), over the course of a year, is less than or equal to the onsite renewable energy generated.”

There are four commonly used ZNE metrics employed within the industry to evaluate a home’s ZNE status: site energy, source energy, costs, and emissions. These metrics result in four possible approaches to determining ZNE: ZNE Site Energy, ZNE Source Energy, ZNE Costs, and ZNE Emissions. Concise descriptions of these four ZNE definitions are provided below. Each of these definitions assumes that a home is connected to the electrical grid and that all surplus energy can be sold. A home’s ZNE status is highly dependent on the ZNE metric used. Different metrics may be appropriate for various purposes, depending on stakeholder objectives. For example, building owners typically care about energy costs. Regulatory organizations, such as the DOE, are concerned with national energy policies, and are typically interested in source energy. A building designer may be interested in site energy use for tradeoffs between features and cost. Finally, stakeholders that are primarily concerned with pollution from power plants and the burning of fossil fuels may be interested in emissions. The following describes the four most commonly used ZNE metrics.

ZNE Site Energy: A *ZNE site energy* home produces as much onsite renewable energy as it uses annually. Site energy does not differentiate fuel types by the amount of energy used to generate, transmit, and distribute energy to the home. It is therefore only necessary to perform a unit conversion so electricity and natural gas can be compared directly. In this TPR, the team has converted all energy sources to British thermal units (Btu) using a unit conversion factor of 3.412 kBtu/kWh. This means that one kWh consumed or produced at a ZNE home is equivalent to 3,412 Btu. Under ZNE site energy, it is possible to consider offsetting only the electricity use at the home with onsite renewables, instead of electricity and natural gas (or other fuel) use. When only offsetting the home’s electricity use, ZNE site energy is called *zero net electric energy* (ZNEE). While ZNEE can provide a measure of electric grid neutrality, it does not fully align with the zero net energy concept, unless it is an all-electric home.

ZNE Source Energy: A *ZNE source energy* home produces as much onsite renewable energy as it uses, measured at the source of energy production. Source energy distinguishes between fuel types in terms of the amount of energy used to generate, transmit, and distribute that energy to the home. The major challenge with source energy is determining the site-to-source energy conversion factors for the various fuel types and locations to account for the generation, transmission, and distribution losses. **Table 14** provides site-to-source energy conversion factors from different organizations for electricity and natural gas.

Table 14: Site-to-Source Conversion Factors for Electricity and Natural Gas

Organization	Electricity	Natural Gas
California Energy Commission (2001)	3.00	1.00
National Renewable Energy Laboratory (2007)	3.19	1.09
American Gas Association (2009)	3.13	1.09
Environmental Protection Agency (2013)	3.14	1.05

Using the 2013 EPA factor, for example, means that one kWh (3,412 Btu) of electricity consumed within a home is assumed to come from an energy source that consumed 3.14 x 3,412 Btu of natural gas. This conversion factor recognizes that it takes more units of fossil fuel (such as natural gas) to generate one unit of electrical energy and deliver it to the home. These factors include the thermal plant conversion inefficiency and losses from the electrical transmission and distribution systems. To further illustrate this point, compare an electric resistance furnace with essentially 100% efficiency and a standard natural gas furnace with a thermal efficiency of around 80%. The electric furnace is preferable using the ZNE site energy method. However, the natural gas furnace is preferable using the source energy method—since the electric furnace requires roughly three times more energy under this method.

ZNE Cost: In a *ZNE cost* home, the amount the homeowner pays the utility for energy services is no more than the amount the utility pays the homeowner for energy the home exports to the grid (on an annual basis). A zero net bill for energy consumption may appeal to homeowners. However, ZNE cost may not result in lower energy use, lower costs to maintain the electric grid, or lower greenhouse gasses emissions. Furthermore, unless the home disconnects from the grid, it would likely be difficult to achieve zero net bill since the utility would still need to recover its fixed costs.

ZNE Emissions: A *ZNE emissions* home generates at least as much emissions-free renewable energy as it uses from emissions-generating energy sources. As with ZNE source energy, the challenge is to develop conversion factors to accurately reflect the emissions associated with the various sources of energy used by the home.

In California, two regulatory agencies, the California Energy Commission (CEC) and the CPUC, are in the process of adopting a new metric to evaluate ZNE homes and buildings. This new metric is named ZNE Time Dependent Valuation (TDV) energy. Instead of using site or source energy, the CEC and CPUC would use TDV energy. The CEC developed the TDV methodology for the 2005 California Building Energy Efficiency Standards (Title 24) and currently uses it to compare building energy performance, to evaluate the cost effectiveness of individual energy efficiency measures, and to perform other code compliance analysis. The TDV energy conversion factor varies for each hour of the year, taking into account the energy use, energy costs, and emissions associated with the generation, transmission, and distribution of the energy (electricity, natural gas, and propane) used by the home and building. This makes the development of conversion factors for TDV energy significantly more complex than source energy conversion factors.

This second TPR evaluates the homes' ZNE status in terms of site energy, source energy, and site electric energy. The Final Technical Report may evaluate the ZNE status using additional definitions and metrics. As in the first TPR, the ZNE calculations exclude energy used for electric vehicle charging.

ZNE Block Homes

With California's goal of all new residential construction reaching ZNE by 2020, the team expects that the ZNE Block homes will provide insights to help California meet its ZNE goal.

ZNE Site Energy Status for ZNE Homes

Figure 38 shows the current ZNE status for homes in the ZNE Block based on site energy for a period of a year starting on November 1, 2013. This figure also includes the total site energy use (divided between its electricity and natural gas energy use), the solar PV generation, and the net site energy use.

Figure 38: ZNE Site Energy Status for ZNE Block Homes (November 1, 2013 to October 31, 2014)

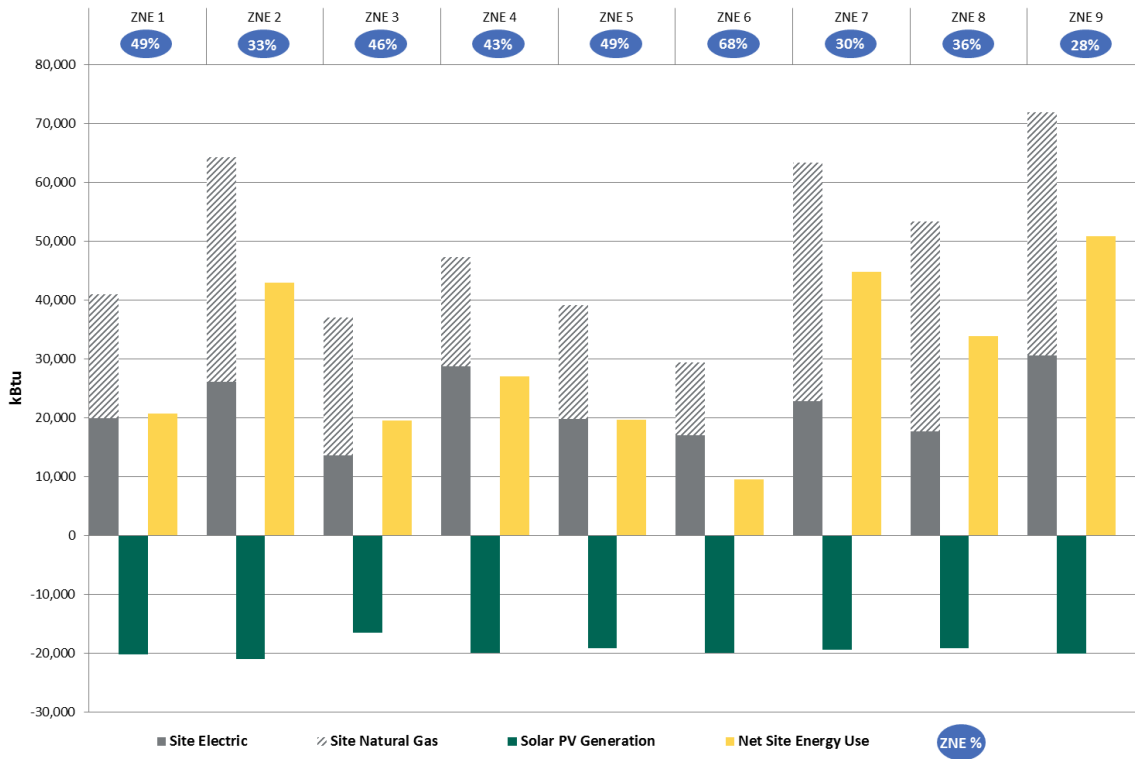

The ZNE status represents a home’s progress toward achieving ZNE. To reach the ZNE goal, a home’s net energy consumption must be zero or negative. The ZNE status is equal to a home’s solar PV generation divided by its total energy consumption. As an example, ZNE 1’s ZNE status is 49%, which is equal to 20,153 kBtu (solar PV generation) divided by 40,882 kBtu (total energy consumption).

None of the homes achieved ZNE status based on site energy. Comparing the homes’ ZNE status to the original forecast made with the eQUEST tool reveals that the homes missed their ZNE targets by an average of 47%. **Table 15** summarizes these results.

Table 15: Actual versus Forecasted ZNE Site Energy Status for the ZNE Block Homes

ZNE Status (%)	ZNE 1	ZNE 2	ZNE 3	ZNE 4	ZNE 5	ZNE 6	ZNE 7	ZNE 8	ZNE 9
eQUEST Simulation	84	73	90	76	83	89	72	87	64
Field Measurement	49	32	43	42	48	68	30	35	27
Decrease from Forecast	42	55	49	43	41	24	58	59	56

The differences between the actual and forecasted ZNE site energy status of the ZNE Block homes is a result of (at least in part) occupant behavior, which have a major impact on household energy consumption. While the energy simulation work incorporated the occupants’ and energy consuming devices’ schedules, both are dynamic and change over time.

Figure 38 also shows that five of the nine ZNE homes (ZNE 2, 3, 7, 8, and 9) use more natural gas than electricity, and two homes (ZNE 4 and 6) use more electricity than natural gas. In the remaining two homes (ZNE 1 and 5), the electricity and natural gas use are similar. While the field measurements for the electricity and natural gas use differ from the energy simulation results, their shares of the total site energy are reasonably similar for most of the ZNE homes, as shown in **Table 16**. This table also shows that the ZNE homes consumed 26% more energy than the eQUEST model predicted. This increased energy use had a significant impact on the homes’ ZNE performance.

Table 16: Actual vs. Forecasted Natural Gas and Electricity Use Percentages for ZNE Block Homes (Site Energy)

Home	Component	Actual Measurement	eQUEST Simulation	Percent Change from eQUEST ¹⁶
ZNE 1	Electricity Share of Energy Use	48%	46%	4%
	Natural Gas Share of Energy Use	52%	54%	(4%)
	Total Site Energy Use (kBtu)	40,882	29,800	37%
ZNE 2	Electricity Share of Energy Use	40%	42%	(5%)
	Natural Gas Share of Energy Use	60%	58%	3%
	Total Site Energy Use (kBtu)	64,153	26,900	138%
ZNE 3	Electricity Share of Energy Use	34%	40%	(15%)
	Natural Gas Share of Energy Use	66%	60%	10%
	Total Site Energy Use (kBtu)	37,014	35,800	3%
ZNE 4	Electricity Share of Energy Use	60%	59%	2%
	Natural Gas Share of Energy Use	40%	41%	(2%)
	Total Site Energy Use (kBtu)	47,276	57,700	(18%)
ZNE 5	Electricity Share of Energy Use	59%	49%	20%
	Natural Gas Share of Energy Use	41%	51%	(20%)
	Total Site Energy Use (kBtu)	39,161	30,800	27%
ZNE 6	Electricity Share of Energy Use	59%	50%	18%
	Natural Gas Share of Energy Use	41%	50%	(18%)
	Total Site Energy Use (kBtu)	29,423	29,000	1%
ZNE 7	Electricity Share of Energy Use	36%	33%	9%
	Natural Gas Share of Energy Use	64%	67%	(4%)
	Total Site Energy Use (kBtu)	63,234	48,400	31%
ZNE 8	Electricity Share of Energy Use	32%	25%	28%
	Natural Gas Share of Energy Use	68%	75%	(9%)
	Total Site Energy Use (kBtu)	53,335	28,900	85%
ZNE 9	Electricity Share of Energy Use	42%	55%	(24%)
	Natural Gas Share of Energy Use	58%	45%	29%
	Total Site Energy Use (kBtu)	71,880	54,300	32%
Totals ¹⁷	Electricity Share of Energy Use	46%	38%	21%
	Natural Gas Share of Energy Use	54%	42%	30%
	Total Site Energy Use (kBtu)	388,792	312,700	26%

Figure 38 also provides the solar PV generation for each home in the ZNE Block. All the houses in the ZNE Block have identical PV arrays with a nominal peak power direct current (DC) of 3.9 kW. To predict the solar PV generation output, the team used the National Renewable Energy Laboratory (NREL) System Advisory Model (SAM) tool. The NREL SAM is a computer model that calculates performance and financial metrics of several renewable energy systems including PV, concentrating solar power, solar water heating, wind, geothermal, and biomass. Of the PV calculation options in SAM, the team used PVWatts model. The PVWatts model is a simplified PV system model, which assumes typical module and inverter characteristics. However, it is an hour-by-hour model that produces results within 5% of a more detailed PV model in SAM for typical flat-panel PV systems.

¹⁶ The percent change is calculated as the difference between the actual measurements and the eQUEST simulation, divided by the eQUEST simulation.

¹⁷ The totals for the percentage splits between electricity and natural gas exclude ZNE 8 since this home had a malfunctioning domestic solar hot water heater for most of this reporting period.

Table 17 compares the field measurements of the solar PV generation output to the PVWatts results. Although these results indicate that the solar PV performance was below the forecast, most of the PVWatts results are in reasonable agreement with the field measurements. One exception is ZNE 3, which generated much less solar PV energy than the simulation results. This was a result of a faulty electrical connection with ZNE 3, which the team has since corrected. One other factor that contributed to the difference between field measurements and forecasted results is the size of the solar PV array. The solar PV arrays installed were 4% smaller than the array size used for the simulations (3.9 kW versus 4.05 kW).

Table 17: Actual versus Forecasted Solar PV Site Energy Generation for the ZNE Block Homes

Solar PV Generation		ZNE 1	ZNE 2	ZNE 3	ZNE 4	ZNE 5	ZNE 6	ZNE 7	ZNE 8	ZNE 9
PVWatts Forecast	kBtu	22,793	22,881	22,813	22,793	23,005	23,251	23,385	23,005	23,285
	kWh	6,680	6,706	6,686	6,680	6,742	6,814	6,854	6,742	6,824
Adjusted PVWatts Forecast	kBtu	21,949	22,033	21,968	21,949	22,153	22,390	22,519	22,153	22,422
	kWh	6,433	6,458	6,439	6,433	6,493	6,562	6,600	6,493	6,572
Actual Solar PV Generation	kBtu	20,153	20,992	16,477	20,012	19,160	19,933	19,399	19,113	20,128
	kWh	5,906	6,152	4,829	5,865	5,615	5,842	5,686	5,602	5,899
Shortfall from Forecast (%)		12	8	28	12	17	14	17	17	14
Shortfall from Adjusted Forecast (%)		8	5	25	9	14	11	14	14	10

It is also important to note that ZNE 1 and ZNE 4 have the same roofline slope and orientation, which resulted in similar actual solar PV generation for both houses (20,153 versus 20,012, a 0.7% difference). The solar PV generation for ZNE 5 and ZNE 8 was also close to each other (19,160 versus 19,113, a 0.2% difference). These homes also have the same roofline slope and orientation. Based on the roofline slope and orientation, the team expected that the solar PV generation of ZNE 3 would be similar to ZNE 2, but it is more than 27% lower due to the electrical connection problem mentioned previously. **Table 18** summarizes the ZNE Block home roofline slope and orientation.

Table 18: Roofline Slope and Orientation for the ZNE Block Homes

Roofline	ZNE 1	ZNE 2	ZNE 3	ZNE 4	ZNE 5	ZNE 6	ZNE 7	ZNE 8	ZNE 9
Slope (degrees)	21	27	27	21	21	21	27	21	27
Orientation/Azimuth (degrees)	244	242	244	244	237	226	222	237	227

ZNE Source Energy Status for ZNE Homes

Figure 39 shows the current ZNE status for homes in the ZNE Block based on source energy for the twelve-month period that ended on October 31, 2014. This figure also shows each home's total source energy use (divided between its electricity and natural gas energy use), the solar PV generation, and the net source energy use.

Figure 39: ZNE Source Energy Status for ZNE Block Homes (November 1, 2013 to October 31, 2014)

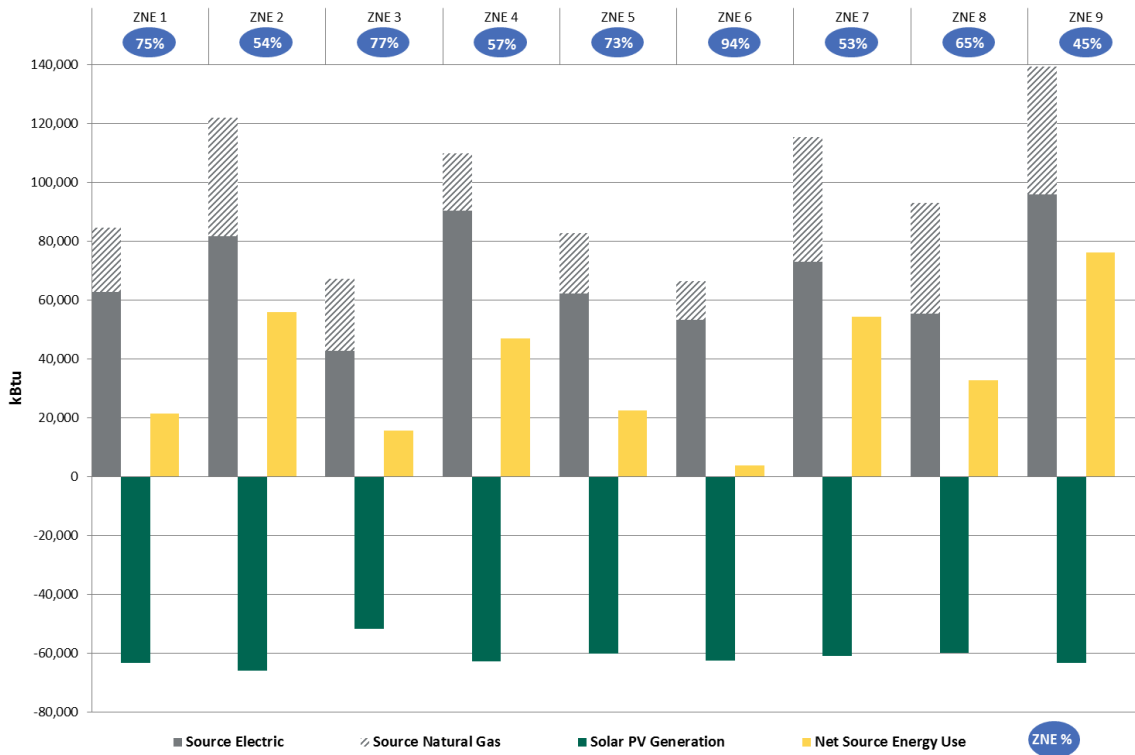

As was the case with the site energy, none of the homes achieved 100% ZNE based on source energy. However, using source energy (rather than site energy) increased the ZNE target achievement by an average of 58% for the ZNE Block homes, as shown in **Table 19**. This increase is due to the fact that one unit of electricity from onsite solar PV generation offsets 3.14 units of natural gas when using source energy.¹⁸ **Figure 39** also shows that all homes use more electricity than natural gas, after applying the site to source energy conversion factors.

Table 19: Source versus Site Energy ZNE Status for the ZNE Block Homes

ZNE Status (%)	ZNE 1	ZNE 2	ZNE 3	ZNE 4	ZNE 5	ZNE 6	ZNE 7	ZNE 8	ZNE 9
Site Energy	49	33	46	43	49	68	30	36	28
Source Energy	75	54	77	57	73	94	53	65	45
Increase from Site Energy	53	64	67	33	49	38	77	81	61

ZNE Site Electric Energy Status for ZNE Homes

Figure 40 shows the current ZNE status for homes in the ZNE Block based on site electric energy for the 12-month period that ended on October 31, 2014. This figure also shows each home’s total site electric energy use, the solar PV generation, and the net site electric energy use. Using the site electric energy metric, the ZNE 1, ZNE 3, ZNE 6, and ZNE 8 homes achieved ZNE, while ZNE 5 achieved 97%.

¹⁸ This report uses the EPA site-to-source conversion factor of 3.14 for electricity.

Figure 40: ZNE Site Electric Energy Status for ZNE Block Homes (November 1, 2013 to October 31, 2014)

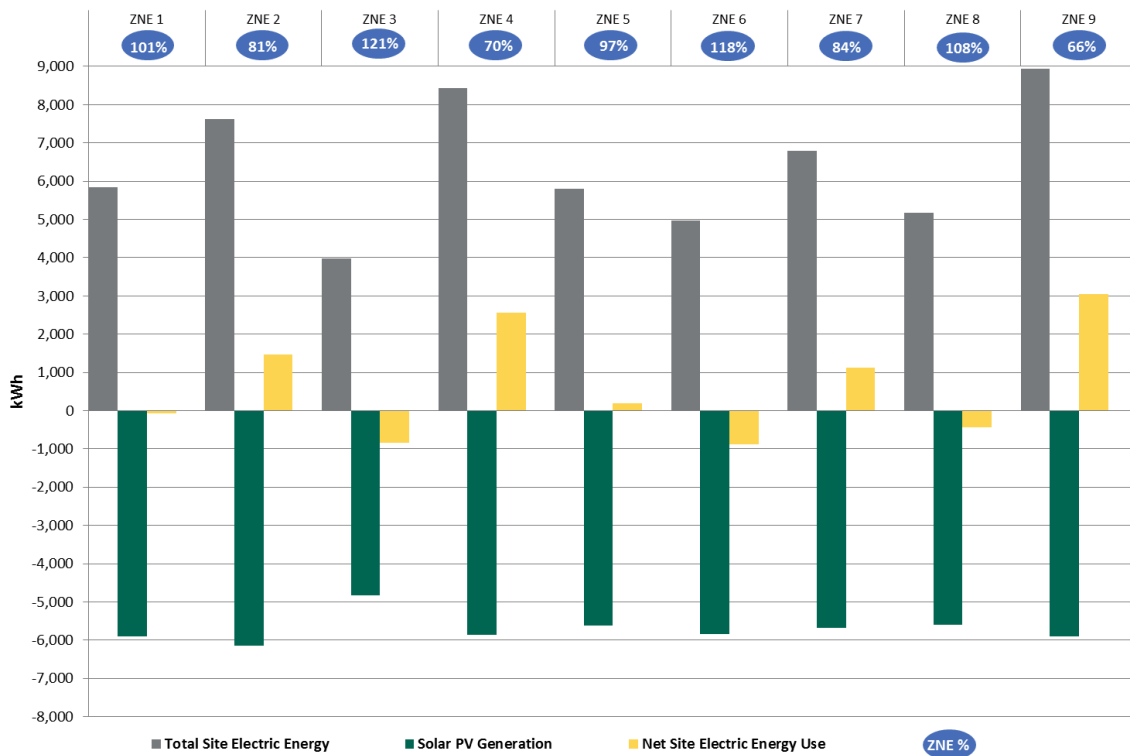

Using site electric energy (rather than site energy) increased the ZNE target achievement by an average of 129% for the ZNE Block homes. **Table 20** summarizes site energy to site electric energy percentage increase of reaching the ZNE status for the homes in the ZNE Block.

Table 20: Site Energy versus Site Electric Energy ZNE Status for the ZNE Block Homes

ZNE Status (%)	ZNE 1	ZNE 2	ZNE 3	ZNE 4	ZNE 5	ZNE 6	ZNE 7	ZNE 8	ZNE 9
Site Energy	49	33	46	43	49	68	30	36	28
Site Electric Energy	101	81	121	70	97	118	84	108	66
Increase from Site Energy to Site Electric Energy	106	145	163	63	98	74	180	200	136

Table 21 shows the ZNE status achieved by the homes in the ZNE Block based on the three metrics used: site energy, source energy, and site electric energy. As can be seen from this table, the ZNE status increases for each home by using the source energy or site electric energy ZNE calculation methods (instead of the site energy method). This is important because it would cost less to achieve ZNE status using this method, since homes would require a smaller solar PV array.

Table 21: Site versus Source versus Site Electric Energy ZNE Status for the ZNE Block Homes

ZNE Status (%)	ZNE 1	ZNE 2	ZNE 3	ZNE 4	ZNE 5	ZNE 6	ZNE 7	ZNE 8	ZNE 9
Site Energy	49	33	46	43	49	68	30	36	28
Source Energy	75	54	77	57	73	94	53	65	45
Site Electric Energy	101	81	121	70	97	118	84	108	66

CES Block Homes

The homes in the CES Block did not receive the full suite of energy efficient measures. However, these homes received ENERGY STAR smart appliances and a solar PV array with a nominal peak power DC of 3.6 kW.¹⁹

ZNE Site Energy Status for CES Homes

Figure 41 shows the current ZNE status for homes in the CES Block based on site energy for the twelve-month period that ended on October 31, 2014. This figure also shows each home's total site energy use (divided between its electricity and natural gas energy use), the solar PV generation, and the net site energy use.

Figure 41: ZNE Site Energy Status for CES Block Homes (November 1, 2013 to October 31, 2014)

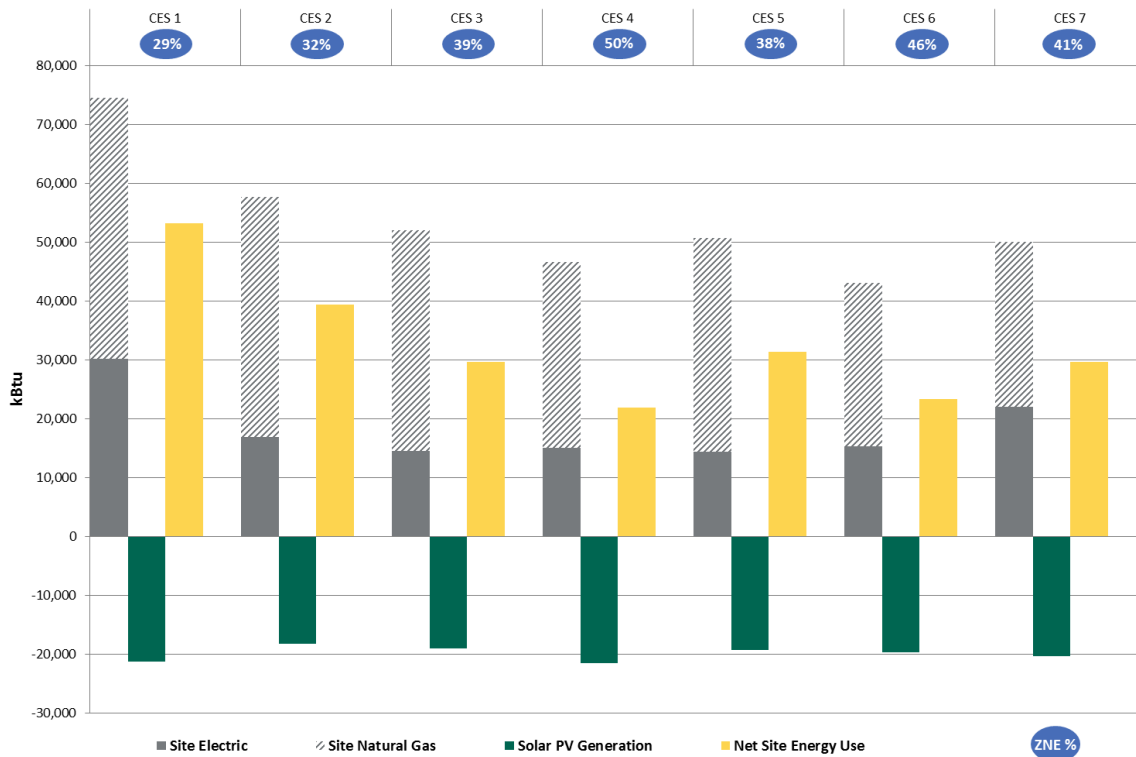

None of the homes in the CES Block achieved ZNE status based on site energy. However, it is not expected that these homes would achieve ZNE status as they did not receive a full suite of energy efficient measures. Similar to the homes in the ZNE Block, **Figure 41** shows that the CES homes have a greater consumption of natural gas than electricity when site energy metric is used.

ZNE Source Energy Status for CES Homes

Figure 42 shows the current ZNE status for homes in the CES Block based on source energy for a period of a year starting on November 1, 2013. This figure also shows each home's total source energy use (divided between its electricity and natural gas energy use), the solar PV generation, and the net source energy use.

¹⁹ Two exceptions are that CES 5 has 3.3 kW array and CES 4 has a 3.8 kW array.

Figure 42: ZNE Source Energy Status for CES Block Homes (November 1, 2013 to October 31, 2014)

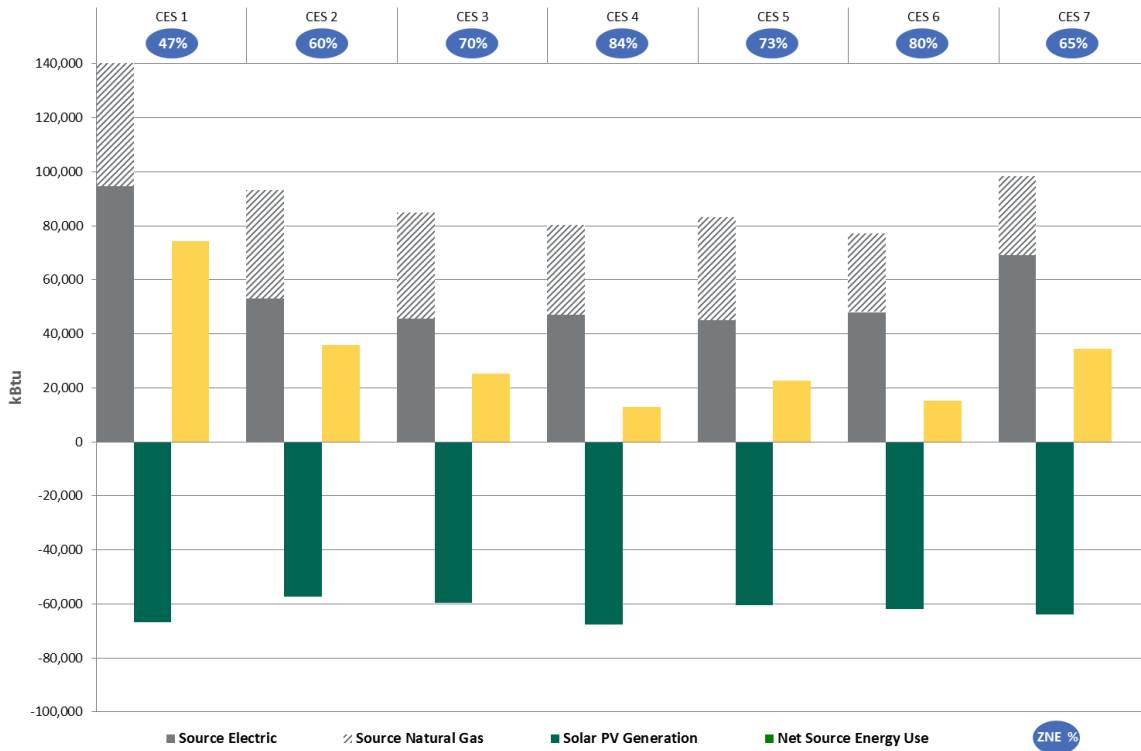

As it was the case with the site energy, none of the homes reached ZNE status based on source energy. However, using source energy, instead of site energy, resulted in an average percentage increase of reaching the ZNE status of 75% for the CES Block homes as shown in **Table 22**.

Table 22: Site Energy versus Source Energy ZNE Status for the CES Block Homes

ZNE Status (%)	CES 1	CES 2	CES 3	CES 4	CES 5	CES 6	CES 7
Site Energy	46	60	70	84	73	80	65
Source Energy	27	32	39	50	38	46	41
Increase from Site Energy to Source Energy	62	88	79	68	92	74	59

Figure 42 also shows that all CES homes use more electricity than gas, after applying the site to source energy conversion factors.

ZNE Site Electric Energy Status for CES Homes

Figure 43 shows the current ZNE status for homes in the CES Block based on site electric energy for a 12-month period ending October 31, 2014. This figure also shows each home’s total site electric energy use, the solar PV generation, and the net site electric energy use. Using the site electric energy metric, CES 2 through CES 6 achieved ZNE status, while CES 7 home was close at 93%.

Figure 43: ZNE Site Electric Energy Status for CES Block Homes (November 1, 2013 to October 31, 2014)

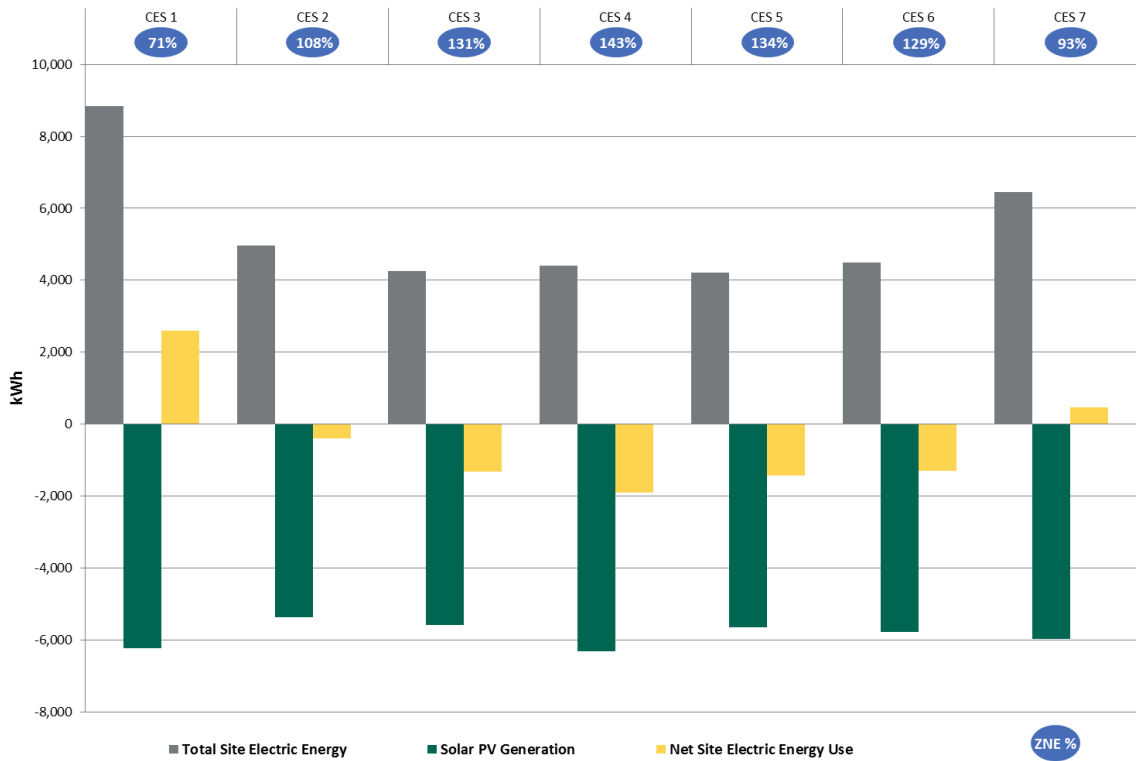

Using site electric energy instead of site energy as the method for assessing the home’s ZNE status increased the home’s ZNE status by an average of 195% for the CES Block homes. **Table 23** summarizes site energy to site electric energy average percentage increase of reaching the ZNE status for homes in the CES Block.

Table 23: Site Electric versus Site Energy ZNE Status for the CES Block Homes

ZNE Status (%)	CES 1	CES 2	CES 3	CES 4	CES 5	CES 6	CES 7
Site Energy	29	32	39	50	38	46	41
Site Electric Energy	71	108	131	143	134	129	93
Increase from Site Energy to Site Electric Energy	145	238	236	186	253	180	127

Table 24 shows the ZNE status achieved by the homes in the CES Block based on the three metrics used: site energy, source energy, and site electric energy. This table also reveals that the homes’ ZNE status improves when changing the ZNE method from site energy to source energy or to site electric. This is important because it would potentially cost less to achieve ZNE under these latter two methods, since it would require smaller solar PV arrays. This reduction in PV array size relates directly to the decrease in the weight given to natural gas use as site energy is replaced with either source energy or site electric energy.

Table 24: Site versus Source versus Site Electric Energy ZNE Status for the CES Block Homes

ZNE Status (%)	CES 1	CES 2	CES 3	CES 4	CES 5	CES 6	CES 7
Site Energy	29	32	39	50	38	46	41
Source Energy	47	60	70	84	73	80	65
Site Electric Energy	71	108	131	143	134	129	93

RESU Block Homes

As is with the CES Block, the homes in the RESU Block did not receive a full suite of energy efficiency measures. However, these homes received ENERGY STAR smart appliances and a solar PV array with a nominal peak DC power of 3.6 kW, except for RESU 1 home, which has nominal peak power DC of 3.8 kW.

ZNE Site Energy Status for RESU Homes

Figure 44 shows the current ZNE status for homes in the RESU Block based on site energy for a period of a year starting on November 1, 2013. This figure also shows each home's total site energy use (divided between its electricity and natural gas energy use), the solar PV generation, and the net site energy use.

Figure 44: ZNE Site Energy Status for RESU Block Homes (November 1, 2013 to October 31, 2014)

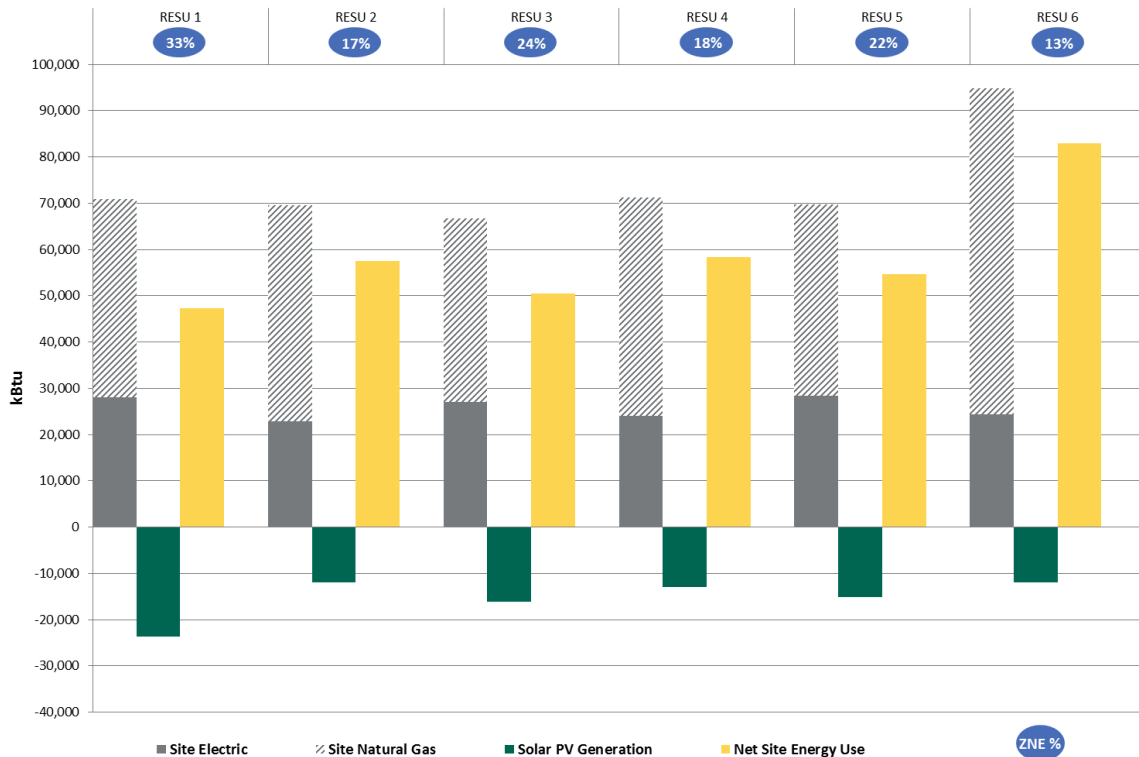

None of the homes in the RESU Block achieved ZNE status based on site energy. However, the team did not expect that these homes would achieve ZNE status since they did not receive a full suite of energy efficient measures. Consistent with the CES Block homes, using the site energy metric results in the RESU homes having higher consumption of natural gas than electricity as shown in **Figure 44**.

ZNE Source Energy Status for RESU Homes

Figure 45 shows the current ZNE status for homes in the RESU Block based on source energy for a period of a year starting on November 1, 2013. This figure also shows each home's total source energy use (divided between its electricity and natural gas energy use), the solar PV generation, and the net source energy use.

Figure 45: ZNE Source Energy Status for RESU Block Homes (November 1, 2013 to October 31, 2014)

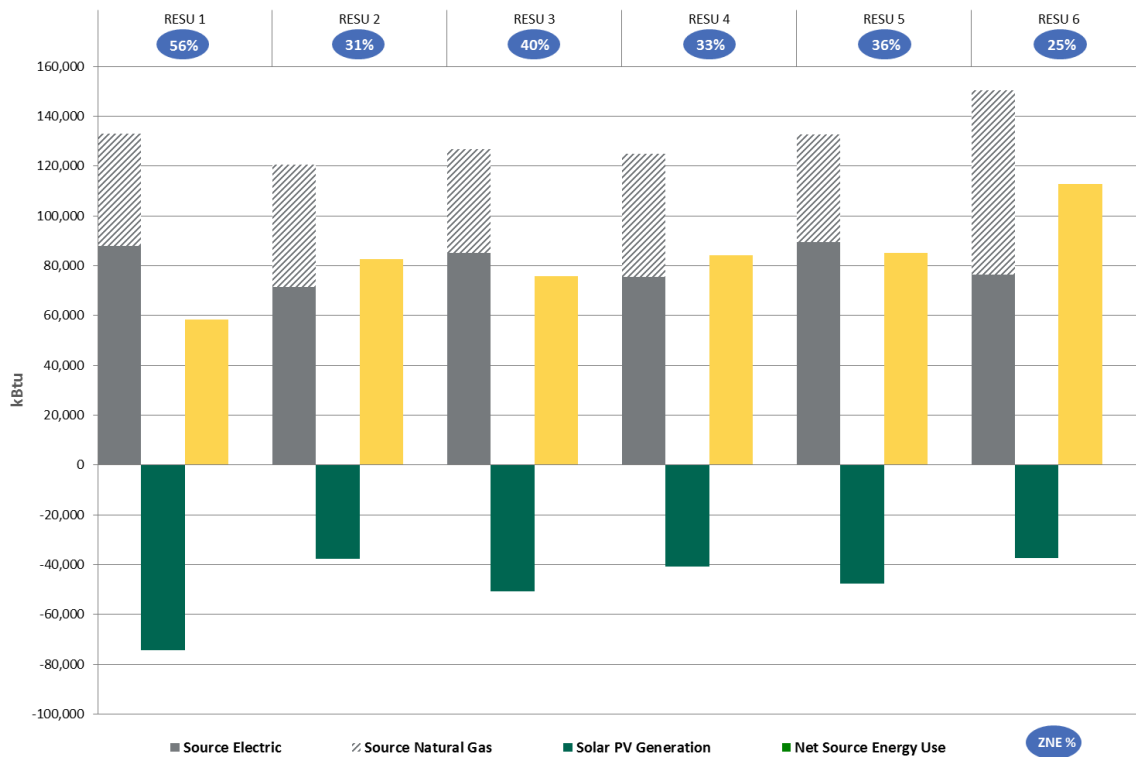

As it was the case with the site energy, none of the home reach ZNE status based on source energy. However, using source energy, instead of site energy, resulted in an average percentage increase of reaching the ZNE status of 76% for the RESU Block homes as shown in **Table 25**.

Table 25: Source versus Site Energy ZNE Status for the RESU Block Homes

ZNE Status (%)	RESU 1	RESU 2	RESU 3	RESU 4	RESU 5	RESU 6
Site Energy	33	17	24	18	22	13
Source Energy	56	31	40	33	36	25
Increase from Site Energy to Source Energy	70	82	67	83	64	92

Figure 45 also shows that all RESU homes use more energy in the form of electricity than in the form of gas, after applying the site to source energy conversion factors.

ZNE Site Electric Energy Status for RESU Homes

Figure 46 shows the current ZNE status for homes on the RESU Block based on site electric energy for the 12 months starting on November 1, 2013. This figure also shows each home’s total site electric energy use, the solar PV generation, and the net site electric energy use.

Figure 46: ZNE Site Electric Energy Status for RESU Block Homes (November 1, 2013 to October 31, 2014)

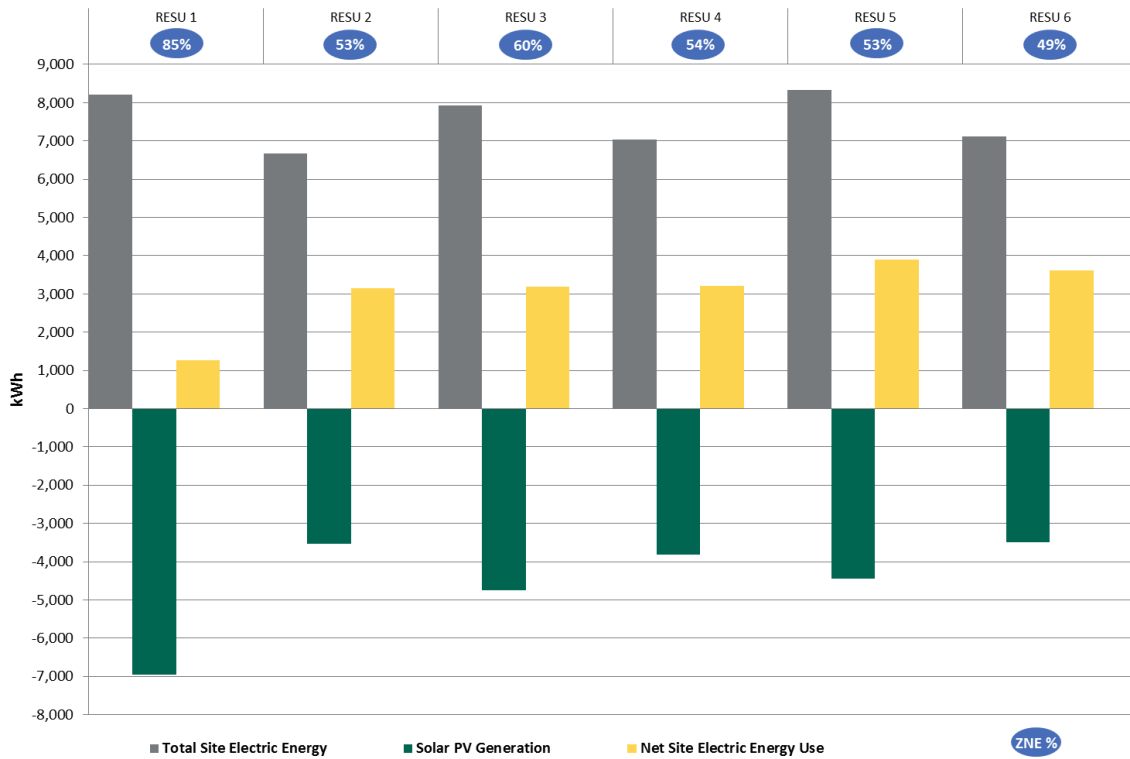

As it was the case with the site energy, none of the home reached ZNE status based on site electric energy. However, using site electric energy, instead of site energy, resulted in an average percentage increase of reaching the ZNE status of 202% for the RESU Block homes as shown in **Table 26**.

Table 26: Site Electric versus Site Energy ZNE Status for the RESU Block Homes

ZNE Status (%)	RESU 1	RESU 2	RESU 3	RESU 4	RESU 5	RESU 6
Site Energy	33	17	24	18	22	13
Site Electric Energy	85	53	60	54	53	59
Increase from Site Energy to Site Electric Energy	158	212	150	200	141	354

Table 27 shows the ZNE status achieved by the homes in the RESU Block based on the three metrics used: site energy, source energy, and site electric energy. This table also indicates that changing the ZNE method from site energy to source energy or to site electric improves the ZNE performance. This is important because it would potentially cost less to achieve ZNE status, as homes would require smaller solar PV arrays. This reduction in solar PV array size relates directly to the decrease in the weight given to natural gas use as site energy is replaced with either source energy or site electric energy.

Table 27: Site vs. Source vs. Site Electric Energy ZNE Status for the RESU Block Homes

ZNE Status (%)	RESU 1	RESU 2	RESU 3	RESU 4	RESU 5	RESU 6
Site Energy	33	17	24	18	22	13
Source Energy	56	31	40	33	36	25
Site Electric Energy	85	53	60	54	53	59

4.1.1.4.2 Field Experiment 1B: Impact of Demand Response Events on Smart Devices, Homes, and Grid

Test 1: Dual PCT-EVSE Demand Response Event (July 24, 2014)

The purpose of this experiment was to evaluate the ability of the project PCTs and EVSEs to simultaneously receive and respond to a duty cycle DR signal. This signal should cause the air conditioners (AC) and electric vehicle chargers to turn off, thereby reducing the homes' electricity loads. This experiment consisted of sending a 100% duty cycle signal from the ISGD Advanced Load Control System (ALCS) via the project smart meters to all 22 participating customer homes.²⁰

The team scheduled the DR event to take place between 3:00 pm and 6:00 pm. Since this was a 100% duty cycle event, the PCTs and EVSEs should have turned off for the entire duration of the three-hour event. Prior to conducting this event, the team adjusted the data collection settings to begin retrieving and storing data for each component in one-minute intervals. The tables below identify the AC units and EVSEs that operated between 2:00 pm and 7:00 pm (within one hour of the DR event period), and describes how they behaved during the DR event.

Out of the 22 homes included within this experiment, six operated their AC units during the DR event. Of these six homes, three responded properly. The AC units in ZNE 3 and ZNE 4 were both off before and during the event, and then turned on when the internal temperature of the homes reached 84° F, which the team verified through the wireless temperature sensors.²¹ ZNE 9 has two AC units. This customer verified that they overrode the DR event on their first AC unit (AC1), and that they allowed their second AC unit (AC2) to participate in the DR event. AC2 remained off throughout the DR event, and then began operating at 6:01 pm after the event ended.

Three homes had AC units that did not respond properly to the DR event. The AC unit in ZNE 7 was operating prior to the DR event and continued to run after the event began. Either the customer overrode this DR event or the PCT did not receive the event signal. The team was unable to confirm the cause, but suspects that the customer overrode the event. The AC units in the other two homes, CES 1 and RESU 5, both turned on during the DR event. The room temperatures in these two homes were below 84° F, so the AC units did not turn on due to their temperatures being above the duty cycle set point. The ISGD team later determined that these homes did not receive the DR event signals due to a loss of communications between the homes' GE Nucleus and the project meter. Since the Nucleus is used to route DR signals from each home's project meter to the home's respective smart appliances and PCTs, this loss of communications means that the team could not deliver DR signals to these devices. The Final Technical Report will address this communications challenge in more detail.

Table 28: PCT Behavior (July 24, 2014)

Home	Unit	On Time	Off Time	Proper Response?	Comments
CES 1	AC2	2:40 pm	3:04 pm	No	Unit ran through the event start
		3:34 pm	4:12 pm	No	Unit turned on during event
		4:35 pm	6:04 pm	No	Unit turned on during event
RESU 5	AC1	4:22 PM	5:04 pm	No	Unit turned on during event
		5:18 pm	6:57 pm	No	Unit turned on during event
ZNE 3	AC2	5:10 pm	6:01 pm	Yes	Unit turned on due to room temp.
ZNE 4	AC1	5:31 pm	6:59 pm	Yes	Unit turned on due to room temp.

²⁰ ALCS reported an error message after the team initiated the event. The team then initiated the same event using the NMS. The team contacted the ALCS help desk the following day and determined that the error was due to a power outage that occurred at the AT Labs in July 2014.

²¹ The ISGD PCTs have implemented the duty cycle DR function by adjusting the temperature setpoint to 84° F. This curtails the PCT until the room temperature rises to 84° F, when the AC unit turns on.

Home	Unit	On Time	Off Time	Proper Response?	Comments
ZNE 7	AC2	2:54 pm	3:49 pm	No	Unit ran through the event start
		4:16 pm	6:59 pm	No	Unit turned on during event
ZNE 9	AC1	2:13 pm	2:36 pm		Pre-event
		3:02 pm	3:19 pm	Yes	Customer override event
		3:45 pm	4:51 pm	Yes	Customer override event
		5:09 pm	6:24 pm	Yes	Customer override event
	AC2	6:01 pm	6:49 pm	Yes	Unit turned on after event finished

The team set up this DR event as a 100% duty cycle event. The team later discovered that the EVSEs interpret and respond to duty cycle signals differently than the PCTs. Whereas the PCTs interpret a 100% duty cycle event as a request to curtail operation, the EVSEs interpret the same signal as a request to charge at 100% of their operating capacity. As a result, none of the three EVSEs that were in use during this DR event responded as the team intended. They continued to operate throughout the event, or until the PEV batteries were fully charged.

Table 29: EVSE Behavior (July 24, 2014)

Home	On Time	Off Time	Power (watts)	Proper Response?	Comments
CES 7	2:34 pm	3:50 pm	3,400	Yes	100% duty cycle allows EVSE to run at full power
	4:02 pm	4:23 pm	3,390	Yes	100% duty cycle allows EVSE to run at full power
	4:24 pm	4:46 pm	640	Yes	Normal step down charge rate
RESU 5	4:34 pm	6:04 pm	3,196	Yes	100% duty cycle allows EVSE to run at full power
ZNE 5	4:47 pm	5:06 pm	3,200	Yes	100% duty cycle allows EVSE to run at full power
	5:07 pm	5:28 pm	680	Yes	Normal step down charge rate

Test 2: Dual PCT-EVSE Demand Response Event (July 28, 2014)

During the DR event on July 24, 2014, a number of homes did not respond as the team expected. Since the team initiated this event through the NMS, due to an error with ALCS, the team suspected that this could have contributed to the unexpected results. The team therefore conducted a similar DR event on July 28, 2014 using ALCS to verify whether the NMS contributed to the results of the previous DR event.

Consistent with the July 24, 2014 experiment, the purpose of this experiment was to evaluate the ability of the project PCTs and EVSEs to simultaneously receive and respond to a duty cycle DR signal. This signal should cause the AC and electric vehicle chargers to turn off, thereby reducing the homes' electricity loads. This experiment consisted of sending a 100% duty cycle signal from the ISGD ALCS via the project smart meters to all 22 participating customer homes.

The team scheduled the DR event to take place between 3:00 pm and 5:00 pm. Since this was a 100% duty cycle event, the PCTs and EVSEs should have turned off for the entire duration of the two-hour event. The tables below identify the AC units and EVSEs that operated between 2:00 pm and 7:00 pm (within one hour of the DR event period), and describes how they behaved during the DR event.

Out of the 22 homes included within this experiment, five operated their AC units during the demand response event. Of these five homes, three responded properly. The second AC unit in ZNE 3 turned on during the event when the room temperature reached 84° F, which the team verified through the wireless temperature sensors. The two AC units in ZNE 7 were both off before and during the event, and then turned on after the DR event was complete. ZNE 9 overrode the DR event on their first AC unit and allowed their second AC unit to participate in the DR event. ZNE 9's second AC unit remained turned off throughout out the DR event, then turned on at 5:02 pm after the event concluded.

Two homes had AC units that did not respond properly to the DR event. The second AC unit in CES 1 turned on at 3:19 pm, during the DR event, and remained on throughout the event. Either the customer overrode the event or the PCT did not receive the event signal. The first AC unit in RESU 5 turned on at 2:58 pm and continued to operate after the event began at 3:00 pm. The room temperature in this home was below 84° F, so the AC unit did not turn on due to the temperature being above the duty cycle set point. Similar to the test performed on July 24, 2014, the ISGD team later determined that these two homes did not receive the DR event signals due to a loss of communications between the homes' GE Nucleus and the project meter. Since the Nucleus is used to route DR signals from each home's project meter to the home's respective smart appliances and PCTs, this loss of communications means that the team could not deliver DR signals to these devices. The Final Technical Report will discuss this communications challenge in more detail.

Table 30: PCT Behavior (July 28, 2014)

Home	Unit	On Time	Off Time	Proper Response?	Comments
CES 1	AC2	3:19 pm	7:00 pm	No	Unit turned on during event
RESU 5	AC1	2:58 PM	4:05 pm	No	Unit ran through the event start
		4:49 pm	5:32 pm	No	Unit turned on during event
		5:18 pm	7:00 pm		Post-event
ZNE 3	AC1	1:21 pm	2:04 pm		Pre-event
	AC2	4:30 pm	5:22 pm	Yes	Unit turned on due to room temp.
		5:30 pm	6:00 pm		Post event
ZNE 7	AC1	2:14 pm	2:36 pm		Pre-event
		5:01 pm	5:37 pm	Yes	Unit turned on after event finished
	AC2	2:10 pm	2:41 pm		Pre-event
		5:01 pm	7:00 pm	Yes	Unit turned on after event finished
ZNE 9	AC1	3:07 pm	6:01 pm	Yes	Customer overrode event
	AC2	5:02 pm	6:01 pm	Yes	Unit turned on after event finished

The team set up this DR event as a 100% duty cycle. Similar to the test performed on July 24, 2014, the team later discovered that the EVSEs interpret and respond to duty cycle signals differently than the PCTs. Whereas the PCTs interpret a 100% duty cycle event as a request to curtail operation, the EVSEs interpret the same signal as a request to charge at 100% of their operating capacity. As a result, none of the three EVSEs that were in use during this DR event responded as the team intended. They continued to operate throughout the event, or until the PEV batteries were fully charged.

Table 31: EVSE Behavior (July 28, 2014)

Home	On Time	Off Time	Power (watts)	Proper Response?	Comments
CES 4	1:00 pm	3:19 pm	3,339	Yes	100% duty cycle allows EVSE to run at full power
	3:20 pm	3:40 pm	702	Yes	Normal step down charge rate
RESU 3	2:23 pm	3:17 pm	3,429	Yes	100% duty cycle allows EVSE to run at full power
	3:18 pm	3:39 pm	691	Yes	Normal step down charge rate
	4:37 pm	5:35 pm	3,433	Yes	100% duty cycle allows EVSE to run at full power
	5:36 pm	5:55 pm	690		Post-event
ZNE 6	6:33 pm	6:59 pm	3,389		Post-event
ZNE 8	2:43 pm	3:21 pm	3,301	Yes	100% duty cycle allows EVSE to run at full power
	5:58 pm	6:29 pm	3,300		Post-event
	6:30 pm	6:57 pm	600		Post-event

Test 3: Dual PCT-EVSE Demand Response Event (July 29, 2014)

The DR events on July 24, 2014 and July 28, 2014 both yielded unexpected results. When attempting to diagnose the communications problem with the PCTs on the CES and RESU blocks, none of which responded to the prior two DR events, the team used the Itron NMS tool to ping the Nucleus devices via the AMI project meters. None of the Nucleus devices on the RESU and CES blocks responded. Interestingly, all the Nucleus devices in the ZNE block homes could be pinged. Although the team has been unable to determine the cause of the loss of Nucleus communications on these two blocks, this explained why these homes’ PCTs did not respond to the DR event. Since the PCTs receive DR signals via the Nucleus, the loss of Nucleus communications means that the Nucleus was unable to pass the DR signals to the PCTs. The Final Technical Report will discuss this communications challenge in more detail.

The team also identified the cause of the unexpected EVSE behavior during the two previous events. The team had erred in assuming that the PCTs and EVSEs respond the same way to 100% duty cycle DR events. Whereas the PCTs interpret a 100% duty cycle event as a request to curtail operation, the EVSEs interpret a 100% duty cycle event as a request to charge at full power. To curtail EVSE charging, the DR event signal should have specified a 0% duty cycle.

The team initiated a duty cycle DR event to all homes on the ZNE block in order to verify that the EVSEs would respond as expected by reducing their charging levels. This test consisted of 25% duty cycle event with a one-hour duration from 4:30 pm to 5:30 pm. The purpose of the 25% duty cycle event was to “throttle” any EVSEs that operated during the event and cause them to charge at a reduced power level. AC units would interpret a 25% duty cycle event as a command to turn off completely, since the ISGD PCTs do not respond to duty cycle events. The tables below identify the AC units and EVSEs that operated between 3:30 pm and 6:30 pm (within one hour of the DR event period), and describes how they behaved during the DR event.

Out of the nine homes included within this experiment, three operated their AC units during the demand response event, and all behaved as expected. The second AC unit in ZNE 3 turned on during the event since the room temperature exceeded the DR set point. The first AC unit in ZNE 7 remained off for the duration of the event, and then turned on after the event ended, while the second AC unit turned off when the event began and turned back on when the event ended. The AC unit in ZNE 9 turned on during the event due to customer override.

Table 32: PCT Behavior (July 29, 2014)

Home	Unit	On Time	Off Time	Proper Response?	Comments
ZNE 3	AC2	4:57 pm	5:27 pm	Yes	Unit turned on due to room temp.
ZNE 7	AC1	3:23 pm	3:39 pm		Pre-event
		5:29 pm	5:55 pm	Yes	Unit turned on after event finished
	AC2	3:06 pm	3:36 pm		Pre-event
		4:19 pm	4:30 pm	Yes	Unit turned off at beginning of event
		5:29 pm	6:21 pm	Yes	Unit turned on after event finished
ZNE 9	AC1	3:25 pm	4:04 pm		Pre-event
		4:54 pm	6:01 pm	Yes	Customer overrode event

The team set up this DR event as a 25% duty cycle. When EVSEs receive DR event signals to reduce the charging level by a certain percentage (such as 25%), the EVSE reduces the charging level based on the maximum charging capacity of the EVSE, not by the current PEV charging rate. The maximum charge rate of the ISGD EVSEs is 7.2 kW, so a 25% duty cycle should reduce the charge rate to approximately 1.8 kW.

Three of the nine ZNE block homes operated their EVSEs during this test, and each of them responded properly. ZNE6 was charging before the event began and then reduced its charging rate once the event began. ZNE 7 began charging—at the proper power level—after the event had already commenced. ZNE 8 was charging at a stepped-down power level when the DR event began, since it was near the end of its charging event. Since this reduced rate is less than 25% of the EVSE maximum charge capacity, its rate of charge did not change once the event began.

Table 33: EVSE Behavior (July 29, 2014)

Home	On Time	Off Time	Power (watts)	Proper Response?	Comments
ZNE 6	4:00 pm	4:29 pm	3,390		Pre-event
	4:30 pm	5:29 pm	1,720	Yes	Charge rate dropped to 25% of EVSE capacity
	5:30 pm	6:41 pm	3,413	Yes	Charge rate returned to full power after event completed
ZNE 7	4:48 pm	5:28 pm	1,763	Yes	Began charging at 25% of EVSE capacity
	5:29 pm	7:06 pm	3,503	Yes	Charge rate returned to full power after event completed
ZNE 8	2:30 pm	4:22 pm	3,300		Pre-event
	4:23 pm	4:48 pm	616	Yes	Normal step down charge rate, below 25% of EVSE capacity

Test 4: Aggregated Demand Response Event using All HAN Devices (September 15, 2014)

The purpose of this experiment was to evaluate the ability of the project’s HAN devices to simultaneously receive and respond to DR signals. This should cause the RESU to discharge energy. It should also cause the AC units, EVSEs, and smart appliances to either turn off or reduce their energy use, depending on whether they are in use. This should result in substantial reductions in the homes’ net electricity loads. Such a capability could be useful for addressing overload conditions on hot weather days. This capability could also help reduce the impacts of the “duck curve” in which low or negative afternoon loads turn sharply higher in the late afternoon as the sun sets—

which reduces solar PV output—and as household energy use increases when customers arrive home. The team scheduled this experiment for September 15, 2014 between 4:00 pm and 9:00 pm, when household energy use is typically the highest.

To prepare the RESUs for the DR event, on the day preceding the event, the team scheduled the RESUs to charge to a 100% SOC, and to maintain this charge level until the event. The team specified a 20% energy reserve, leaving 80% available for the DR event. Since each RESU can store 10 kWh of energy, each RESU would have 8 kWh available for discharge. The RESUs determine their energy output level by dividing the available energy by the event duration. Since this DR event was to have a 5-hour duration and each RESU had 8 kWh of available energy, each RESU should have discharged at approximately 1.6 kW over the entire DR event.

The DR event for the AC units consisted of a “degree offset” event whereby the PCT set points are increased. This event changed the set points by 4° F. For example, if a customer had their AC set to turn on when the room temperature reaches 80° F, during the DR event the AC unit would only turn on if the room temperature reaches 84° F. In no case could the PCT be set to a temperature higher than 84° F.

The DR event for the EVSEs consisted of a 0% duty cycle between 4:00 pm and 9:00 pm, and a 25% duty cycle between 9:00 pm and 12:00 am. This should have caused the EVSEs to stop charging at 4:00 pm, or not begin charging between 4:00 pm and 9:00 pm. It should have also caused the EVSEs to charge at a reduced rate between 9:00 pm and midnight.

The DR event for smart appliances consisted of a “critical” DR event signal, which should have caused the appliances to either reduce their energy consumption—if they were already in use when the event began—or delay their start if a customer tried to use them after the event had already begun.

The following table summarizes the details of this DR experiment in terms of the DR resources, the number of homes, the DR event signals and the event durations.

Table 34: DR Event Details for September 15, 2014

DR Resource	Participant Homes	DR Event Type	Event Duration
RESU	ZNE Block and RESU Blocks (14 homes)	Discharge at constant rate over 5 hour period	4:00 pm to 9:00 pm
PCT	All Blocks (22 homes)	4 degree offset	4:00 pm to 9:00 pm
EVSE	All Blocks (22 homes)	1. 0% duty cycle 2. 25% duty cycle	1. 4:00 pm to 9:00 pm 2. 9:00 pm to midnight
Smart Appliances	All Blocks (22 homes)	Critical DR event	4:00 pm to 9:00 pm

At 4:00 pm, all 14 RESUs began discharging at approximately 1.6 kW, consistent with the team’s expectations. At 7:20 pm, RESU4 stopped discharging, although it had approximately 2.2 kWh of stored energy available for discharge. The homeowner confirmed that they inadvertently cancelled the event manually via the RESU touchscreen. The remaining 13 RESUs continued to discharge until the end of the event at 9:00 pm. **Figure 47** depicts the average power output and SOC of these 13 RESUs throughout the DR event.

Figure 47: Average RESU Power and State of Charge (September 15, 2014)

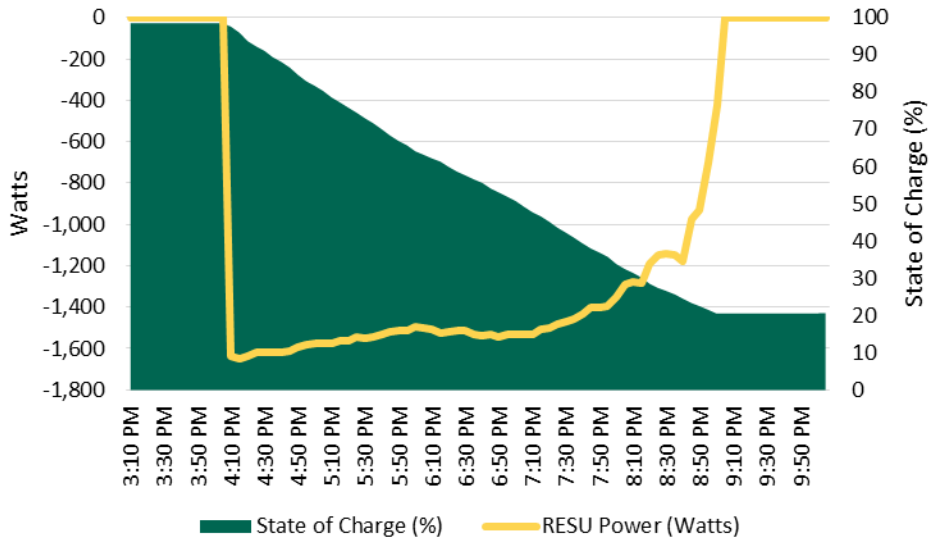

As the RESUs neared the end of the DR event, their rates of discharge declined more quickly than the team expected. These declines were greater than what the team observed during the initial lab testing prior to ISGD deployment, and resulted from the RESUs having less energy available than expected during the initial power calculation at the beginning of the DR event (i.e., when the RESU calculates the average rate of discharge over the course of the event). In order to continue discharging throughout the duration of the DR event, as the event progressed the RESUs’ internal control systems began reducing power to extend the discharge period of the remaining available energy. This behavior was due to the RESUs’ batteries having a lower capacity than during their initial lab tests, and the inability of the RESUs to adjust to the capacity degradation.

Out of the 22 homes included in this experiment, 12 operated their AC units during the DR event. Of these 12 homes, eight responded properly to the DR event signal and four did not. Of the eight homes that responded properly, five had AC units that shut down when the event began. These AC units then resumed operation later during the event when the room temperatures reached their DR event-adjusted set points. The other three homes that responded properly turned off when the event began, and then turned on during the event when the room temperatures reached their DR event-adjusted set points. The four homes that did not respond properly had a loss of communications between their project meter and Nucleus. The PCTs in these homes therefore did not receive the DR event signals.

Table 35: PCT Behavior (September 15, 2014)

Home	Unit	On Time	Off Time	Proper Response?	Comments
CES 1	AC2	3:00 pm	4:41 pm	No	Loss of communication with Nucleus
		4:49 pm	6:06 pm	No	Loss of communication with Nucleus
		6:22 pm	6:59 pm	No	Loss of communication with Nucleus
		7:06 pm	10:10 pm	No	Loss of communication with Nucleus
CES 7	AC2	4:51 pm	5:54 pm	Yes	Room temp reached 84° F
		6:01 pm	10:02 pm	Yes	Room temp reached 84° F
RESU 2	AC1	2:00 pm	6:01 pm	No	Loss of communication with Nucleus
		9:01 pm	10:01 pm	No	Unit turned on after event finished, but this was coincidental; there was no communication with the Nucleus

Home	Unit	On Time	Off Time	Proper Response?	Comments
RESU 5	AC1	3:00 pm	4:01 pm	Yes	Unit turned off at event start
		6:45 pm	7:01 pm	Yes	Room temperature (82°F) likely exceeded set point
		7:30 pm	9:22 pm	Yes	Room temperature (82°F) likely exceeded set point
RESU 6	AC1	8:50 pm	9:16 pm	No	Loss of communication with Nucleus
	AC2	2:04 pm	3:58 pm		Pre-event
		4:15 pm	6:02 pm	No	Loss of communication with Nucleus
		6:44 pm	7:07 pm	No	Loss of communication with Nucleus
ZNE 1	AC1	2:05 pm	3:17 pm		Pre-event
		3:31 pm	4:01 pm	Yes	Unit turned off at event start
		5:28 pm	5:37 pm	Yes	Room temp reached 82° F
		5:42 pm	5:55 pm	Yes	Room temp reached 82° F
ZNE 2	AC2	2:58 pm	7:01 pm	No	Loss of communication with Nucleus
		8:46 pm	11:00 pm	No	Loss of communication with Nucleus
ZNE 3	AC1	2:00 pm	4:01 pm	Yes	Unit turned off at event start
		5:24 pm	5:41 pm	Yes	Room temp reached 82° F
		6:03 pm	6:20 pm	Yes	Room temp reached 82° F
		7:22 pm	7:36 pm	Yes	Room temp reached 82° F
		8:55 pm	9:44 pm	Yes	Room temp reached 82° F
ZNE 4	AC1	2:00 pm	4:01 pm	Yes	Unit turned off at event start
		5:27 pm	6:32 pm	Yes	Room temp reached 88° F
		8:17 pm	8:56 pm	Yes	Room temp reached 88° F
ZNE 5	AC1	6:56 pm	7:01 pm	Yes	Room temp reached 88° F
		7:06 pm	10:53 pm	Yes	Room temp reached 88° F
ZNE 6	AC1	3:16 pm	3:37 pm		Pre-event
		3:51 pm	4:01 pm	Yes	Unit turned off at event start
		5:44 pm	6:02 pm	Yes	Room temp reached 86° F
		6:05 pm	6:17 pm	Yes	Room temp reached 86° F
		6:49 pm	7:10 pm	Yes	Room temp reached 86° F
ZNE 9	AC1	6:15 pm	9:20 pm	Yes	Room temp reached 83° F
	AC2	6:16 pm	7:57 pm	Yes	Room temp reached 83° F
		8:02 pm	8:16 pm	Yes	Customer override event

Seven of the 22 homes operated their EVSEs during this test, and each of them responded properly. Two homes, CES3 and ZNE5 were operating their EVSEs immediately prior to the event, and then curtailed their charging when the event began at 4:00 pm. The other five homes began charging immediately after the event completed at 9:00 pm. The original intent of this test event was to perform two separate DR events for the EVSEs: 0% duty cycle between 4:00 pm and 9:00 pm, and 25% duty cycle between 9:00 pm and 12:00 am. The team initiated both events using ALCS, but only the first event actually occurred. The team determined that sequential DR events require a gap of at least one minute in between. Since the second event occurred immediately after the first—with no time in between—ALCS ignored the second event. The team performed another set of sequential EVSE DR events on September 18, 2014 to verify that it could perform sequential DR events, but with a five-minute interval between the events.

Table 36: EVSE Behavior (September 15, 2014)

Home	On Time	Off Time	Power (watts)	Proper Response?	Comments
CES 3	3:00 pm	4:01 pm	730	Yes	Unit turned off at event start
	9:01 pm	9:57 pm	3,510	Yes	Unit returned to full power at event end
CES 7	9:01 pm	11:00 pm	3,386	Yes	Unit turned on at full power at event end
RESU 1	9:01 pm	11:00 pm	3,700	Yes	Unit turned on at full power at event end
RESU 5	9:00 pm	10:55 pm	3,237	Yes	Unit turned on at full power at event end
RESU 6	9:01 pm	10:57 pm	701	Yes	Unit turned on at ramp-down power at event end
ZNE 6	9:01 pm	10:11 pm	633	Yes	Unit turned on at ramp-down power at event end
ZNE 5	3:22 pm	4:01 pm	690	Yes	Unit turned off at event start

Figure 48 provides a decomposed view of RESU 5’s load and generation during the DR event. At 4:00 pm the total household load dropped to and remained at nearly zero throughout the DR event. The AC was the only major source of load prior to the event. Since the RESU discharged during the event, and since the home was also generating solar PV, the net household load (indicated by the black line), was negative. The household provided approximately 3 kW of negative load (generation) back the grid when the DR event began, and maintained negative load until around 7:30 pm, when the AC turned on because the room temperature exceeded 82°F. When the DR event concluded at 9:00 pm, the RESU stopped discharging and the EVSE began operating.

Figure 48: RESU 5 Load Summary (September 15, 2014)

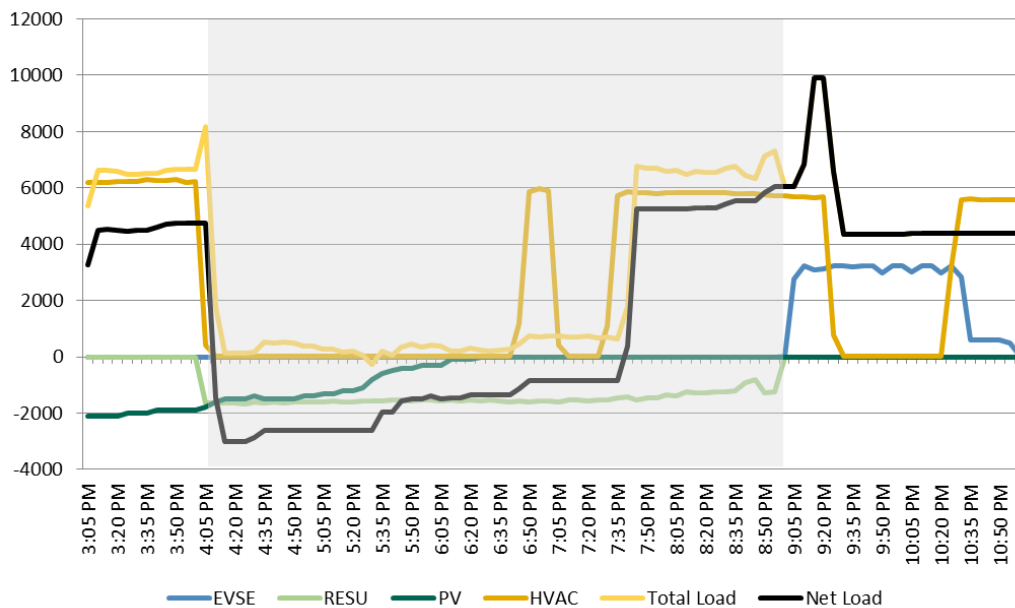

Although the team initiated a critical DR event for the smart appliances, only the nine homes on the ZNE Block and two homes on the RESU Block had Nucleus devices that were communicating with the project meters. The team was unable to identify any load reductions that resulted from the DR event. The team is performing additional laboratory testing on the three smart appliances to assess the DR capabilities of these devices.

Test 5: Sequential EVSE Demand Response Events (September 18, 2014)

The purpose of this experiment was to verify that the team could perform sequential DR events using the ISGD EVSEs. On September 15, 2014, the team attempted to perform two sequential DR events. All the EVSEs operating during the first DR event responded properly. However, no EVSEs responded during the second event. The team determined that sequential DR events require a gap of at least one minute in between. Since the second event occurred immediately after the first—with no time in between—ALCS ignored the second event.

On September 18, 2014, the team attempted to repeat the test performed on September 15, 2014. However, rather than scheduling the second event to begin immediately after the first, the second event would now begin five minutes after the end of the first event. This test therefore consisted of a 0% duty cycle between 4:00 pm and 9:00 pm, and a 25% duty cycle between 9:05 pm and 12:05 am. This should have caused the EVSEs to stop charging at 4:00 pm, or not begin charging between 4:00 pm and 9:00 pm. It should have also caused the EVSEs to charge at a reduced rate between 9:05 pm and 12:05 am. Each of the EVSEs that attempted to operate during the test event behaved properly, with one potential exception. CES 7 stopped charging completed at the beginning of the second event, when it should have reduced its charging level the 25% of the EVSE capacity. The team suspects that the EVSE tripped at the beginning of the second event at 9:05 pm, and that the customer turned it back on at 10:48 pm. At 10:48 pm, the EVSE properly resumed charging at the reduced power level. **Table 37** summarizes the EVSE activity during the test.

Table 37: EVSE Behavior (September 18, 2014)

Home	On Time	Off Time	Power (watts)	Proper Response?	Comments
CES 5	11:00 pm	0:04 am	1,730	Yes	Began charging at 25% of EVSE capacity during event 2
	0:05 am	0:32 am	3,490	Yes	Increased to full power after event #2
CES 7	3:41 pm	4:01 pm	3,310	Yes	Turned off at beginning of event #1
	9:01 pm	9:05 pm	3,340	Yes	Turned on at full power after event #1
	9:06 pm	10:47 pm	0	No	Turned off at beginning of event #2; should have decreased to 25% of EVSE capacity
	10:48 pm	0:05 am	1,720	Yes	Decreased to 25% of EVSE capacity during event #2
	0:06 am	1:16 am	3,434	Yes	Increased to full power after event #2
RESU 1	3:47 pm	4:00 pm	3,660	Yes	Turned off at beginning of event #1
	9:00 pm	9:04 pm	3,670	Yes	Turned on at full power after event #1
	9:05 pm	0:04 am	1,670	Yes	Decreased to 25% of EVSE capacity at beginning of event #2
	0:05 am	0:42 am	3,660	Yes	Increased to full power after event #2
RESU 3	9:01 pm	9:04 pm	3,420	Yes	Turned on at full power after event #1
	9:05 pm	10:37 pm	1,680	Yes	Decreased to 25% of EVSE capacity at beginning of event #2
	10:38 pm	10:53 pm	650	Yes	Normal step down charge rate, below 25% of EVSE capacity
RESU 5	9:00 pm	9:02 pm	3,040	Yes	Turned on at full power after event #1
	9:03 pm	9:19 pm	548	Yes	Normal step down charge rate, below

Home	On Time	Off Time	Power (watts)	Proper Response?	Comments
					25% of EVSE capacity
	10:19 pm	0:04 am	1,506	Yes	Turned on at 25% of EVSE capacity during event #2
	0:05 am	1:12 am	3,040	Yes	Increased to full power after event #2
RESU 6	9:00 pm	9:04 pm	3,500	Yes	Turned on at full power after event #1
	9:05 pm	0:03 am	1,740	Yes	Decreased to 25% of EVSE capacity at beginning of event #2
	0:04 am	0:15 am	670		Post-event; normal ramp down rate
ZNE 6	3:27 pm	3:42 am	3,440		Pre-event
	3:43 pm	4:00 pm	650	Yes	Turned off at beginning of event #1
ZNE 8	10:40 pm	0:04 am	1,680	Yes	Turned on at 25% of EVSE capacity during event #2
	0:05 am	0:17 am	3,400	Yes	Increased to full power after event #2

Test 6: Pre-Cool Homes Using PCT Demand Response (October 3, 2014)

The purpose of this experiment was to evaluate the viability of using the project PCTs as a load source. If the team could use DR event signals to turn on AC units to pre-cool a group of homes in the morning and midday periods, then it could potentially reduce the AC energy use in the afternoon peak-period. This capability could potentially be useful for load shifting and other applications such as absorbing surplus solar generation, which could help avoid curtailing renewable generation.

The team's approach was to pre-cool the homes between 9:00 am and 2:00 pm by gradually reducing the temperature set points by one degree each hour between 9:00 am and 12:00 pm. The team would then increase the set points by performing a four-degree temperature offset DR event between 2:00 pm and 6:00 pm. The test included the following sequence of distinct DR events:

- (1) 9:00 am to 10:00 am – temperature set point at 79°F
- (2) 10:00 am to 11:00 am – temperature set point at 78°F
- (3) 11:00 am to 12:00 pm – temperature set point at 77°F
- (4) 12:00 pm to 2:00 pm – temperature set point at 76°F
- (5) 2:00 pm to 6:00 pm – four-degree temperature offset

As the team executed the first DR event, they learned that the project PCTs do not allow pre-cooling. These PCTs ignore commands to reduce their temperature set point below their current temperature set point. The PCTs treat all DR events as “load shedding” events and, therefore, do not respond to DR signals that increases their energy use.

The failure of the PCTs to allow pre-cooling demonstrated the need for vendors to allow flexibility when designing DR capable devices. With changing loads in California resulting from the proliferation of renewable energy resources like rooftop solar, there may be times when the electrical grid can benefit from surplus renewable energy. Designing DR-capable equipment with the flexibility to either increase or reduce electricity use depending on the needs of the grid will best serve the future needs of the electric grid.

While the team could not execute the pre-cool part of this test, the load shedding by the AC units behaved as expected. Load shedding by the smart appliances did not appear to work correctly.

4.1.1.4.3 Field Experiment 1C: RESU Peak Load Shaving

Test 1: Secure Load Backup (July 8, 2014)

On July 8, 2014, a scheduled power outage occurred within the residential community where the ISGD project homes are located. This interrupted electric service between 9:40 am and 3:05 pm. Fourteen homes on the RESU and ZNE blocks are equipped with RESUs, which provided electricity to “secure loads” during the outage. The secure loads in these homes consist mainly of kitchen refrigerators and garage door openers. At least one home also has a garage refrigerator and a forced air unit on the secure load circuit. The RESUs also allowed the homes’ solar PV arrays to remain operational over much of the period. The RESUs would capture the PV energy generated over much of the period.

At the time of this outage, the RESUs were operating in “PV capture” mode. This mode causes the RESUs to capture the excess solar PV energy not consumed within the home and to discharge it to support the house load at night. This helps to minimize a home’s need to draw power from the electric grid. When the power outage began at 9:40 am, service was interrupted to all homes in the neighborhood. However, all 14 RESUs successfully detected this grid outage and immediately began providing backup power to the secure loads—for each respective home with a RESU. Most of the RESUs were at a 20% state of charge, the reserved capacity, since the PV Capture mode caused the RESUs to discharge to this level the prior evening. Two exceptions were ZNE 5 and ZNE 6, which were at 34% and 63%, respectively, due the homeowners’ low consumption the prior evening. Because these homes’ SOCs were higher when the outage occurred, they reached the max SOC at 1:00 pm and 11:35 am, respectively. The remaining RESUs reached a full charge between 1:20 pm and 2:45 pm. **Figure 49** summarizes the RESU SOCs throughout the day of the outage event.

Figure 49: RESU States of Charge (July 8, 2014)

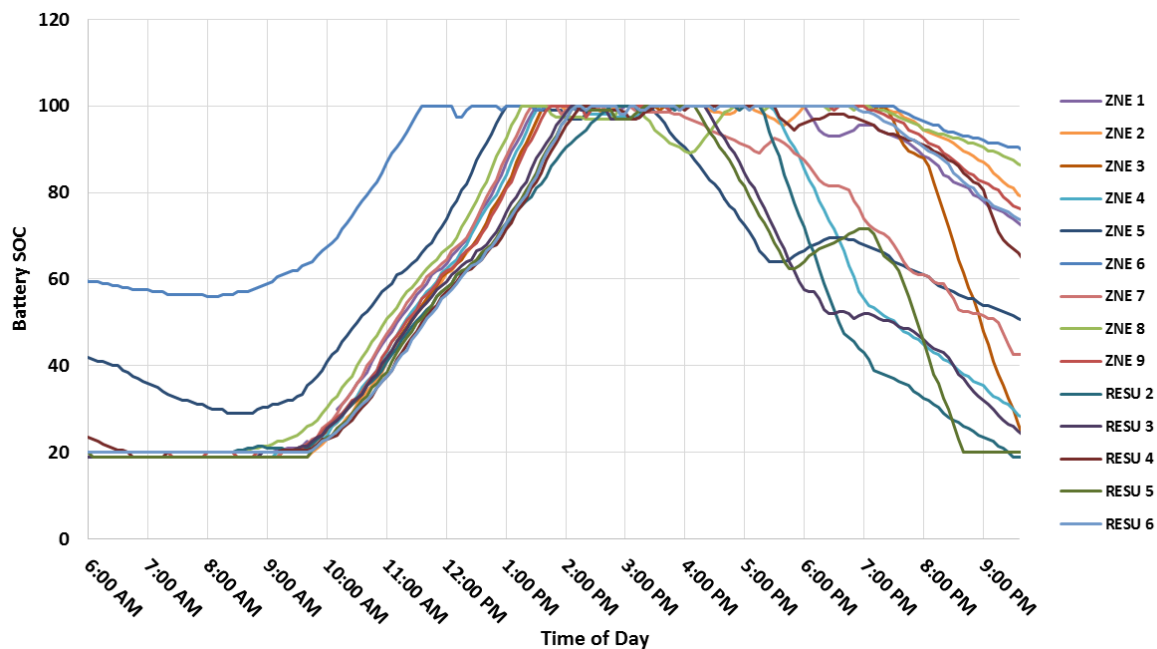

The solar PV output stopped briefly when the outage began, and then resumed operation in “backup” mode. The RESUs began charging their internal batteries with the excess solar PV generation. This excess energy equals the solar PV output less the energy required to operate the RESUs and to power the secure loads. During the outage, the 14 RESUs each stored substantial amounts of energy while also continuously powering the secure loads. As the

RESUs approached their maximum SOCs, the RESU inverters reduced the solar PV generation to provide only for the RESU system and secure loads. This internal RESU control prevents battery overcharging and system trips. When a RESU reached its maximum state of charge, the charge rate would drop to zero, then periodically increase in order to “top off” the battery. Once the outage event completed at 3:10 pm, all solar PV generation resumed within five minutes. **Figure 50** summarizes the solar PV output for each RESU home on the day of the outage event.

Figure 50: Solar PV Generation Output (July 8, 2014)

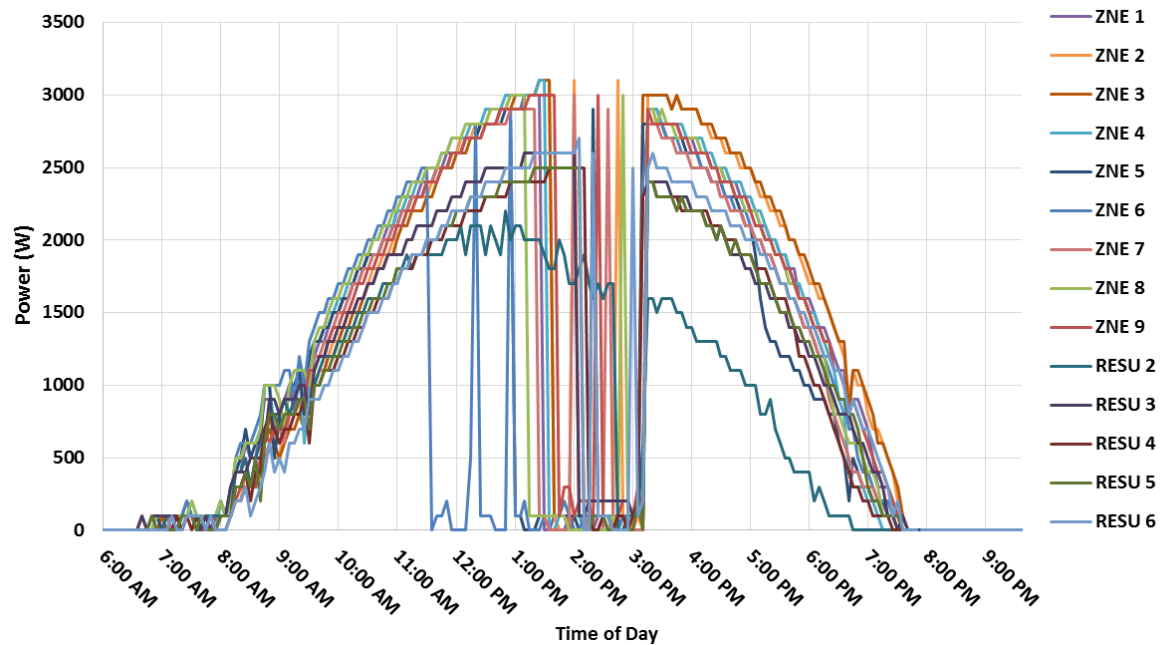

The secure loads within each of the 14 RESU homes received sufficient power to operate throughout the event. Since most loads consist of an ENERGY STAR refrigerator and a garage door opener, power levels and overall energy consumption remained low throughout the event. **Figure 51** summarizes the secure load power demands for each RESU home during the power outage.

Figure 51: RESU Secure Load Power Levels During Outage (July 8, 2014)

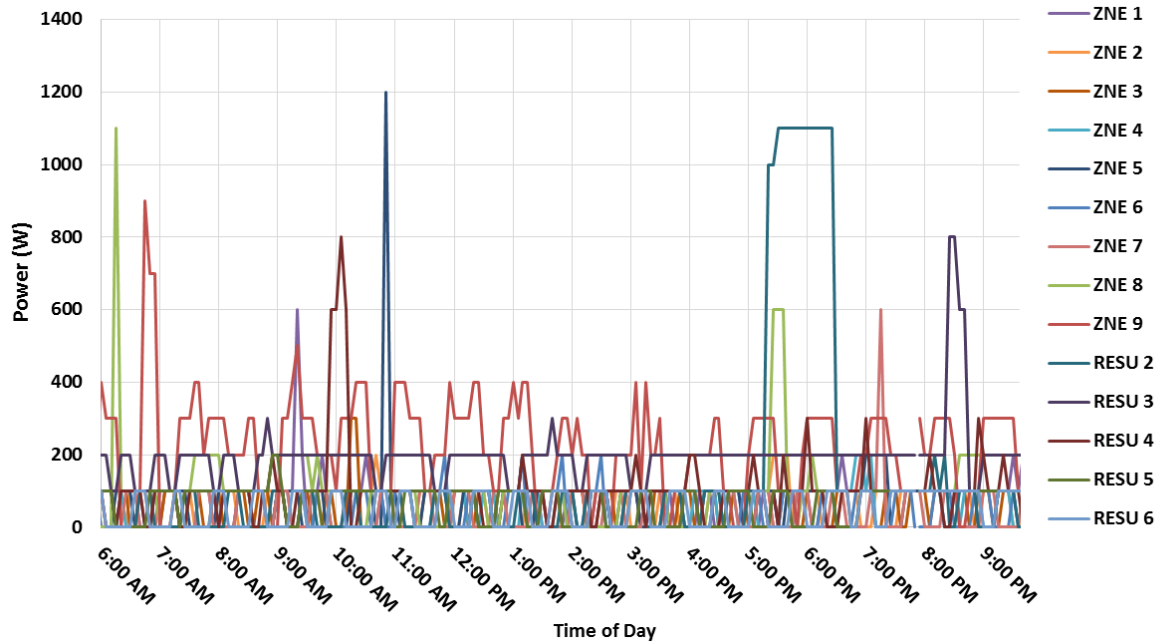

During the outage event, the ISGD project’s data acquisition system components and 4G radios turned off since they were not connected to the RESU secure load circuits. As a result, the team’s only data source during the event was the RESU internal data logs. The ISGD team recommends that data acquisition systems used for future projects should connect to a backup power source, where possible.

All 14 RESUs reached their maximum SOC during the outage due to a combination of low loading on the secure load circuits and high solar PV generation. Connecting additional loads to the secure load circuit could make additional use of solar PV generation during long-duration grid outages. However, during nighttime outages, a RESU would not receive any PV generation. The secure loads could therefore potentially consume all the RESU’s stored energy.

Test 2: Time-Based Permanent Load Shifting (October 10, 2014 to November 10, 2014)

The ISGD team had not completed this experiment as of October 31, 2014. The Final Technical Report will include the results of this experiment.

4.1.1.4.4 Field Experiment 1D: RESU Level Demand

Test 1: RESU PV Capture (February 25, 2014 to October 9, 2014)

The purpose of the RESU PV Capture experiment was to demonstrate how RESUs could help customers store surplus solar PV generation for later use. Such a mismatch occurs when solar PV generation exceeds a home’s current electricity demand. For example, solar PV output is highest during the midday hours, when customers are often not at home and electricity use is low. Operating the RESU in PV Capture mode would store this energy for later use, potentially during the evening. Customers participating in utility net energy metering (NEM) programs would not benefit from this RESU mode, since they receive credit for the surplus solar PV they feed back to the grid.

To operate the RESUs in PV Capture mode, the team first configured each of the 14 project RESUs to operate in the Cap Demand mode. The Cap Demand mode causes a RESU to either charge or discharge based on current

household demand (measured by each respective RESU). Since the intent of this experiment is to store excess solar PV generation, the team configured the Cap Demand set point to 0 kW. If household demand exceeds 0 kW (meaning the household demand is greater than the current solar PV generation), then the RESU discharges. If household demand is below 0 kW (meaning there is surplus PV feeding back to the grid), then the RESU charges. Each battery was allowed to operate between 20% and 100% state of charge.

During the experiment, which lasted 226 days, the solar PV arrays of the 14 RESU homes generated approximately 59.8 megawatt-hours (MWh) DC of solar PV energy. Of this amount, approximately 27% was exported to the grid immediately, 36% was used by the homes immediately, and 37% was stored in the RESUs for later use (either by home loads or by exporting to the grid).

The long duration of this experiment highlighted multiple RESU issues. While most homes were able to generate full solar PV power, two RESU homes had faulty solar PV electrical connections that resulted in lower solar PV output. Another home had shading issues that resulted in the home generating approximately 27% less solar PV energy than adjacent homes.

During the test period, several RESUs experienced operational failures of various durations. The team replaced two RESUs with spares. During the 226-day test period (5,424 hours), 16 RESU failures resulted in 2,191 hours of unscheduled downtime across the 14 RESUs. This equates to system uptime of approximately 97%. These RESU issues are described in more detail below.

Throughout the test period, each RESU received between 2,800 and 5,000 kWh DC. RESU 2 experienced significant shading, which affected its power production, while RESU 6 had a problem with its solar PV electrical connection, which the team resolved on June 20, 2014. **Figure 52** summarizes the cumulative solar PV generation for each RESU home over the course of this experiment. The slope for RESU 6 increases after the team fixed the electrical connection.

Figure 52: Cumulative Solar PV Generation

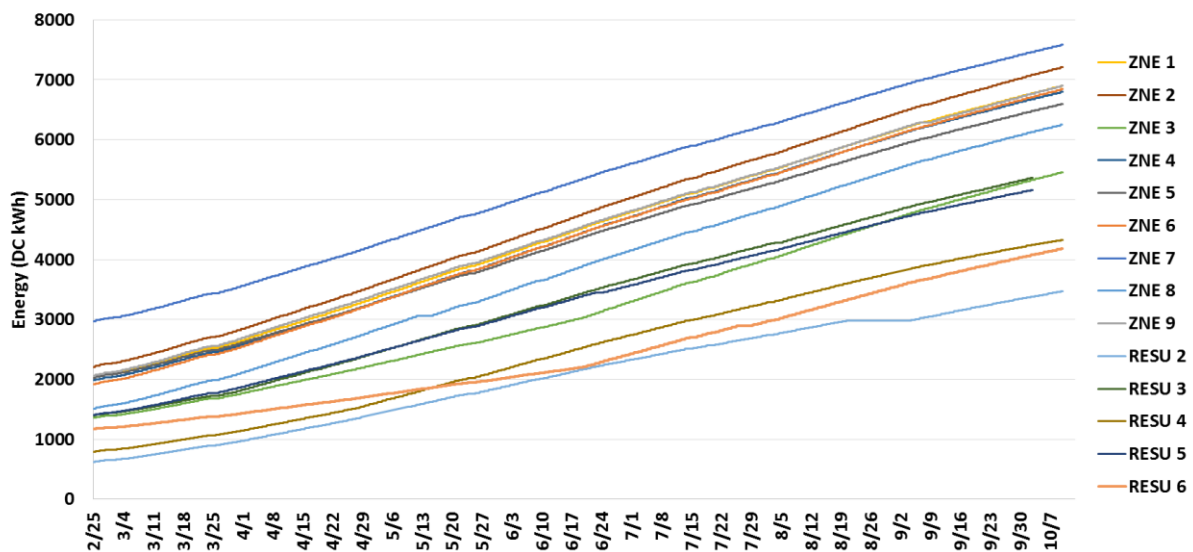

The intent of the PV Capture experiment is to use the RESU to absorb surplus solar PV energy and then discharge this energy when household electricity demand exceeds the solar PV output. **Figure 53** plots the household demand for each RESU home on July 4, 2014. Each of the homes' RESUs absorbed the surplus solar PV up until approximately 1:00 pm, as indicated by the relatively flat and positive demand levels. Beginning at approximately

1:00 pm the RESUs began to reach 100% state of charge and the RESUs started exporting the surplus solar PV to the grid. The RESUs continued to export the surplus solar PV to the grid until about 6:00 pm. Near the end of the solar PV generation period, the RESUs began discharging to make up for the solar PV shortfall to maintain household demand at 0 kW (for most homes).

Figure 53: RESU Home Demand (July 4, 2014)

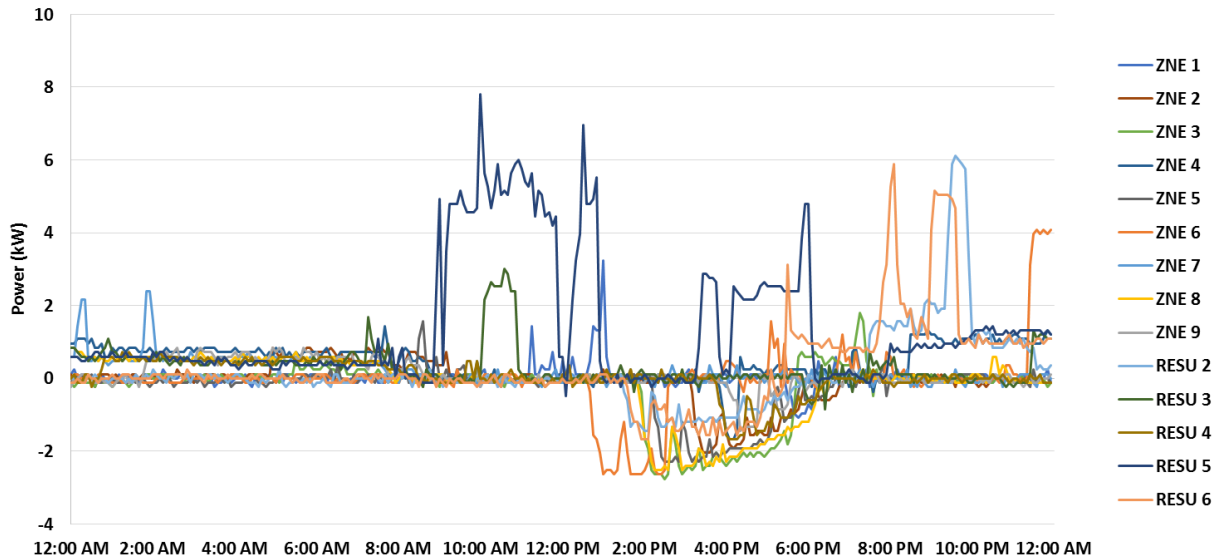

Since the objective of this experiment is to evaluate a method for limiting the amount of solar PV generation exported to the grid, a useful metric for evaluating the experiment's effectiveness is the percentage of solar PV generation exported. **Figure 54** summarizes the solar PV energy generated for each RESU home, the solar PV energy exported the grid, and the percentage of solar PV energy exported to the grid. The team adjusted the solar PV energy DC (measured by the RESUs) based on their 92% DC/AC efficiency metric to determine the AC energy amounts. This figure reveals that operating the RESUs in the PV Capture configuration allows the homes to consume between 60% and 88% of their solar PV energy. Interestingly, the ZNE Block homes exported approximately 9% more solar PV energy than the RESU Block homes. This is likely due to the ZNE Block homes generating more solar PV energy. These homes also received a series of energy efficiency upgrades, which help them to consume less energy.

Figure 54: Solar PV Generation and Export

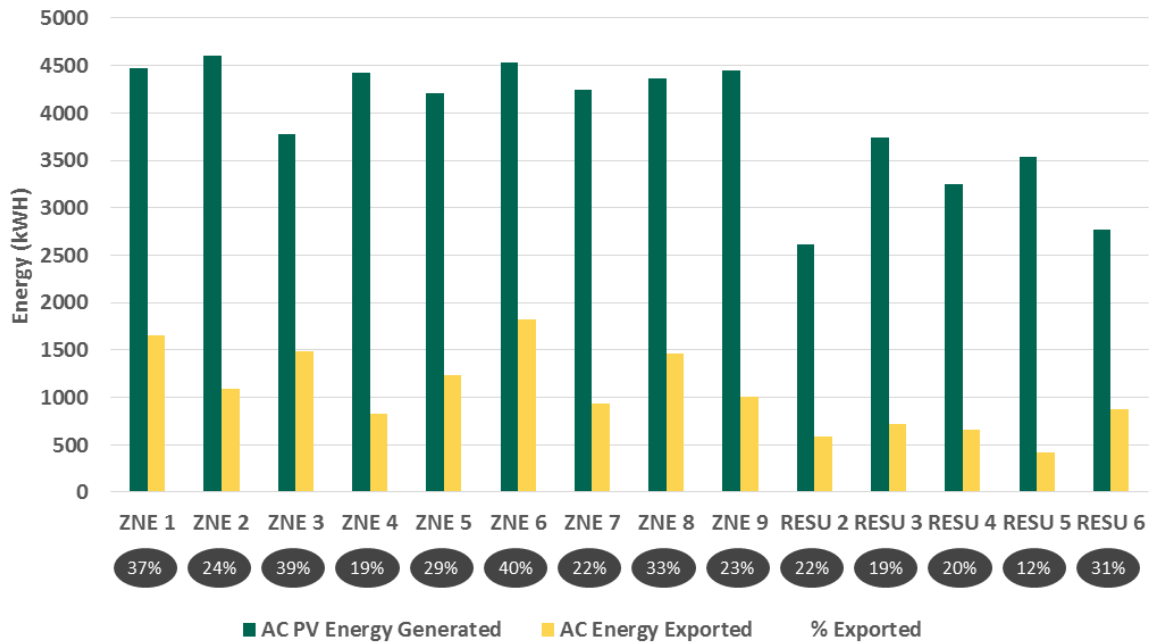

Between March 1, 2013 and October 31, 2015, the team identified five operational issues with the RESUs, four of which caused the RESUs not to operate in their intended mode. These five issues are described below. The team has worked closely with the vendor to identify the root causes and develop solutions. The first two issues have been resolved, and the ISGD team is working to identify solutions for the remaining three. The team continues to monitor the RESUs closely to identify and resolve any potential issues that arise in the future. The total downtime for the 14 RESUs over this eight-month period was approximately 2,000 hours, which means the RESUs were operational more than 97% of the time.

Battery Discharge Level: While operating the in the Cap Demand mode as part of the PV Capture experiment, three RESUs discharged below their minimum state of charge set points. This error prevents further battery charging and discharging. The team sent a remote reboot signal to each RESU to clear the error. The RESU vendor determined that this error resulted from an error with the program logic for the Cap Demand mode. The vendor provided a software update to fix this problem.

Electrical Noise: Random electrical noise on the internal communication wiring caused faults on two RESUs. On-site RESU reboots were required to clear the errors. The team has received, tested, and installed a software upgrade to improve system stability. The team updated all 14 RESUs with this software over a three-day period that ended on September 24, 2014. If a noise-induced communication fault occurs, the software upgrade will cause the RESU to log the fault, reset the system, and resume normal operation. Since the software upgrade, several RESUs have experience this error. The software upgrade functioned appropriately and the RESU cleared the error without any downtime.

Battery Charge Level: There was one incident where the battery charged beyond its operating limits. RESUs are designed to stop charging based on the average voltage of all the battery modules. Differences between the modules' SOC can result in a higher or lower voltage between modules, as the BMS programming allows some variation. One module's voltage significantly exceeded the average voltage, resulting in it being charged over its operating limits. The BMS ultimately protected the system by stopping RESU operation. The BMS should have "balanced" the module voltages to prevent this type of issue. However, the BMS for this particular RESU did not

function as intended in late February 2014. A failed battery module may have also caused this issue. The team replaced this RESU with a spare unit. The RESU vendor is continuing to investigate the root cause of this failure.

Weekly Automatic Reboot Failure: The RESUs reboot on a weekly basis in order to clear the memory of the Windows CE operating system used for the RESU touchscreen. Three RESU failed to reboot after a weekly automatic reboot. This RESU required an on-site power cycle to clear the error. The RESU vendor determined that the cause of this error is due to the operating system that controls the touchscreen. The RESU vendor could not obtain support from the software vendor, and will thus not provide a solution to this problem. Any future product release for consumer use would likely require a software redesign. The ISGD team continues to monitor the RESUs and plans to manually reboot any RESUs that experience this error again.

BMS Fault: One RESU indicated a BMS fault on its battery pack, which immediately caused the RESU to stop all battery and inverter operations. The team was unsuccessful in rebooting the RESU remotely. The team replaced this RESU with a spare unit, and is currently working with the RESU vendor to investigate the failure's root cause.

4.1.1.4.5 Field Experiment 1E: CES Permanent Load Shifting

Test 1: CES Traditional Permanent Load Shifting (January 13, 2014 to September 20, 2014)

The purpose of this test was to evaluate the ability of the CES to operate in a Traditional Permanent Load Shifting (PLS) capacity over an 8-month test period. The CES was programmed to follow a consistent schedule, charging during traditionally off-peak nighttime hours (between 12:15 am and 6:15 am) and discharging during traditionally on-peak afternoon hours (between 12:15 pm and 5:45 pm). This differed from the initial PLS test summarized in the first TPR. The initial PLS test was designed to charge the CES during periods when solar PV output was highest, and then discharge during periods of maximum home electricity use—typically in the late afternoon and early evening. Operating the CES using the Traditional PLS schedule should also impact the load profile of the CES Block transformer.

The team performed this test between January 13, 2014 and September 20, 2014. The load shifting profile was programmed into the Distributed Energy Manager (DEM), which controls the CES device via DNP3 using a 4G radio connection. Once the team programmed the profile in the DEM, the DEM automatically controlled the CES throughout the duration of the test.

Figure 55 summarizes the PLS profiles that the team designed and used for both PV PLS test (performed for the first TPR) and the Traditional PLS test.

Figure 55: CES Permanent Load Shifting Profiles

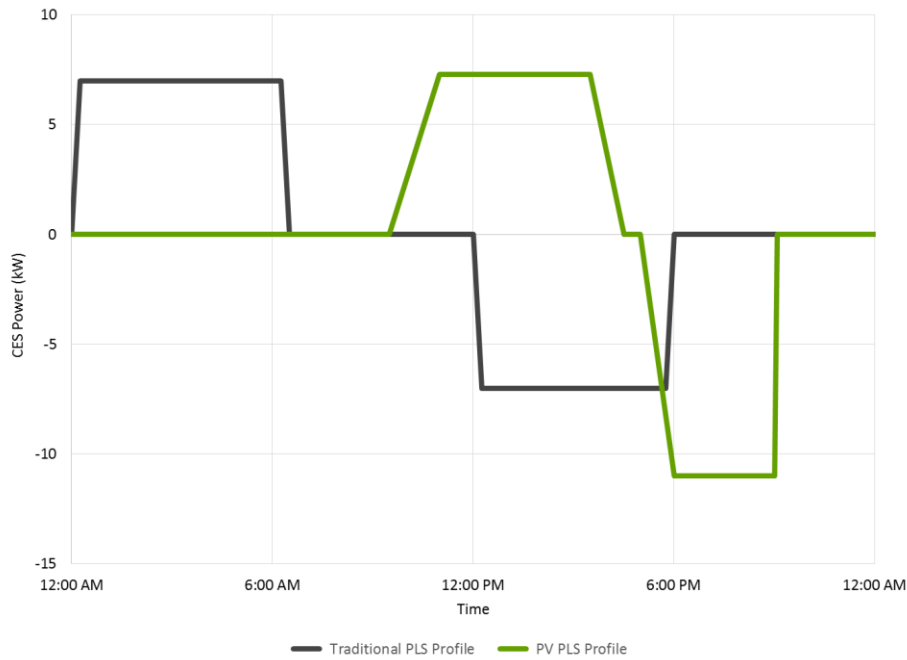

The CES charged and discharged in a manner consistent with the Traditional PLS schedule throughout the entire experiment period. The CES performed maintenance charges whenever it finished a discharge, and it performed maintenance discharges whenever it finished a charge. The purpose of the maintenance charges is to bring the CES SOC to within the thresholds configured within the CES. **Figure 56** summarizes the Traditional PLS schedule and the charge and discharge profiles for the week of September 15, 2014.

Figure 56: Measured CES Power Versus PLS Profile



The Traditional PLS profile actually added to the transformer loading both when the CES charged and when it discharged. By charging during the early morning hours, the CES added to the transformer loading, and by discharging in the afternoon hours, it added to the solar PV generation that was flowing back through the transformer. The Traditional PLS profile, therefore, caused the CES to place more strain on the distribution transformer. **Figure 57** summarizes the measured load of the CES, the CES Block transformer and CES Block load profiles for September 19, 2014. The first PLS test that the ISGD team performed (summarized in TPR #1) had the opposite impact on the distribution transformer. In that test, the CES charged when solar PV output was highest, which reduced the back feeding through the transformer. Likewise, the CES discharged when household energy use was highest, which also reduced transformer loading.

Figure 57: Load Profiles of CES, CES Block Transformer, and CES Block Load (September 19, 2014)

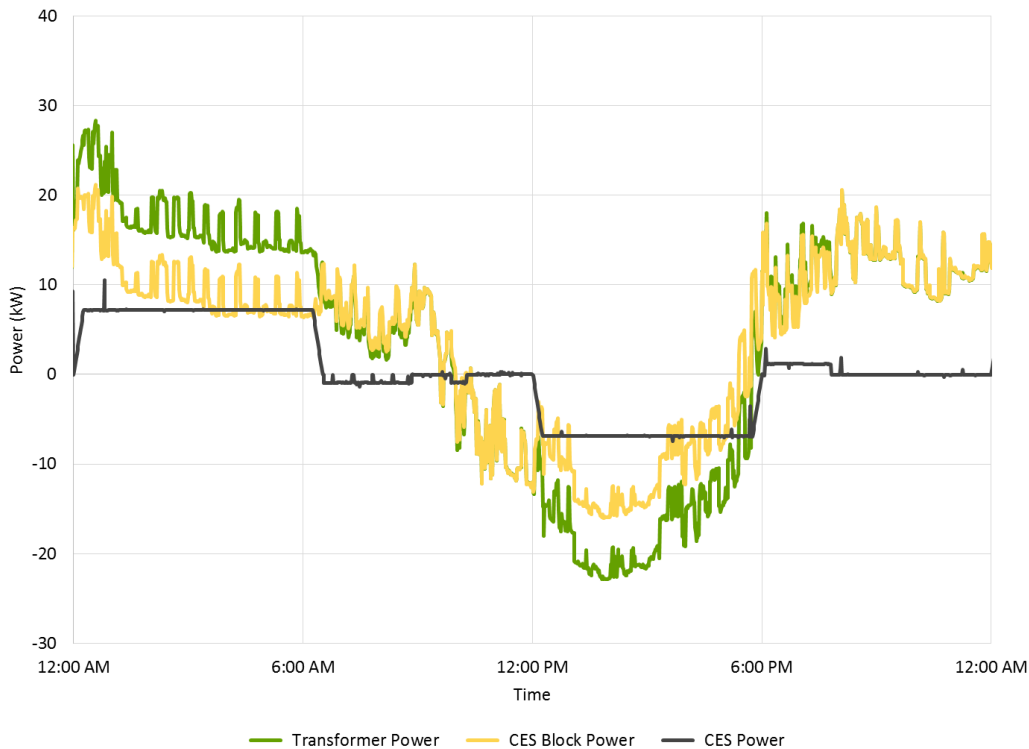

Test 2: Evaluation of CES’s Potential to Support Islanding

When the ISGD team commissioned the CES in June 2013, they configured it to operate in parallel with the distribution transformer by using a bypass switch for the CES. In this configuration, the distribution transformer would provide service to the customers residing on the CES block. In the event of an outage, these customers would experience a service interruption since the CES and bypass switch configuration would not support islanding. In this configuration, the CES would see and respond to grid outages by ceasing to charge or discharge, but it could not provide power to the homes in the neighborhood.

To allow the CES to service the neighborhood, the CES’s load connection switch would need to be closed and the bypass switch opened. **Figure 58** shows the electrical configuration of the CES. The CES would then be able to supply power to the homes in the neighborhood in the event of a grid outage. To avoid any unexpected issues that may arise when making these configuration changes, the ISGD team has been monitoring the load characteristics of the neighborhood and the CES’s behavior during grid events.

Figure 58: CES One Line Diagram

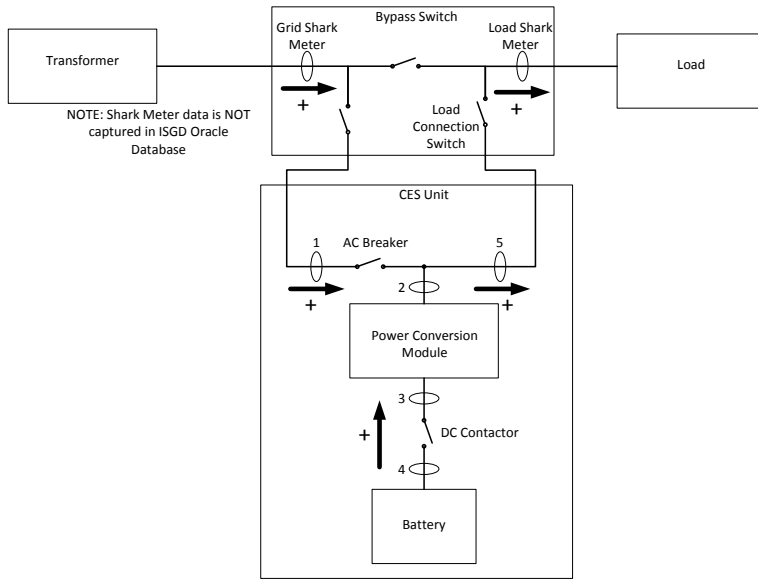

The CES Block load profile follows the same basic trend every week. In general, the neighborhood experiences loading that exceeds 10 kW between 4:00 pm and 1:00 am, and solar PV generation that exceeds 10 kW between 9:00 am and 4:00 pm. **Figure 59** summarizes this profile over a typical week.

Figure 59: CES Block Load Profile (Week of September 1, 2014)

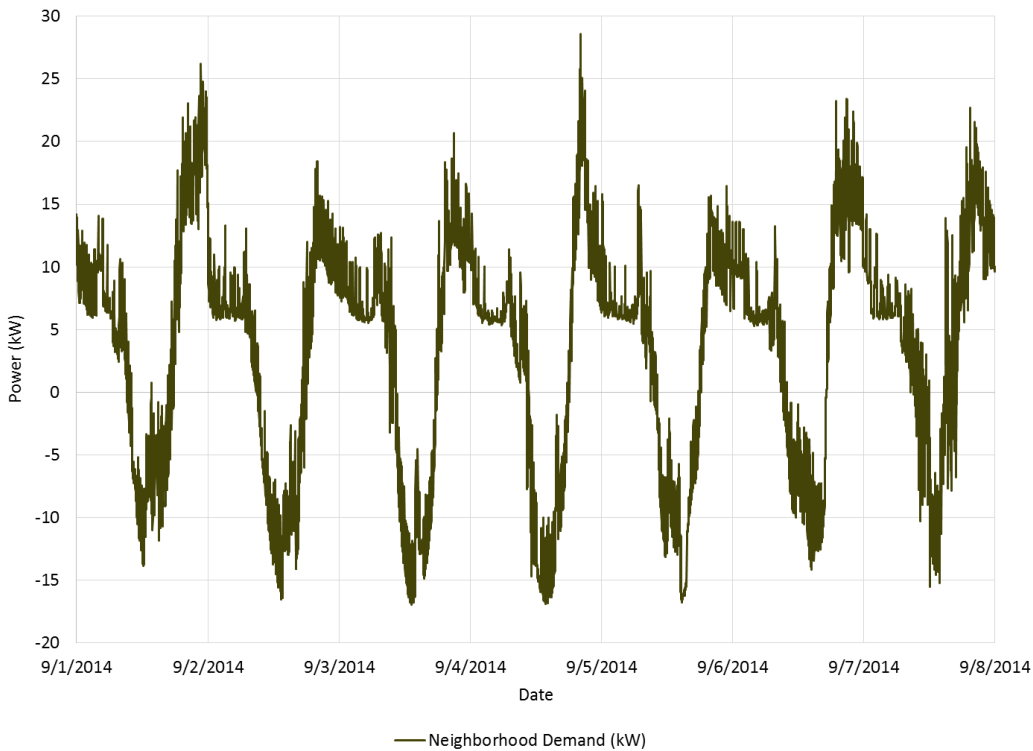

The CES can support loads as high as 100 kVA while grid connected. The neighborhood’s demand has never exceeded 50 kVA, so the CES should have sufficient load throughput capacity to serve this block when grid-

connected. If a grid outage causes the CES to initiate islanding, the CES can only support the neighborhood until the battery has discharged its available energy. A few conditions could cause the CES to trip while islanded, but it would resume normal operation once grid service returns. If the CES does trip during an outage, the customer impact would be the same with or without the CES—in both cases customers would experience the outage. The three potential conditions that would cause the CES to trip when operating in islanded mode are: (1) when the load exceeds 62.5 kVA, (2) when the load is between 25 kVA and 62.5 kVA for longer than three seconds, and (3) when the CES battery becomes fully discharged. The daily peak load of the CES Block is usually less than 25 kW, but it exceeds 25 kW at least twice a month. If the CES islands and one of these trip conditions are met, the CES will trip. It is therefore critical that the CES only islands during a real grid outage. Otherwise, if the CES islands unnecessarily and then trips, it would cause an outage that would not have occurred without the CES.

Over a period of several months, the ISGD team observed the CES’s grid connection behavior to verify that it only islanded during appropriate grid events. Prior to September 10, 2014, the CES islanded at least twice a month. According to the logs generated by the CES, in all but one of those islanding events the reason the CES islanded was quick (less than 160 ms) voltage sags. The ISGD team performed experiments using a replicate CES at EVTC to refine the CES’s islanding settings. The new settings made the CES less sensitive to normal grid disturbances, while still maintaining compliance with SCE’s Rule 21.²²

On September 10, 2014, the team performed a firmware update on the CES and applied the new islanding condition settings. Since applying these new settings, the team has detected two voltage sag events that would have caused the CES to island if the team had not updated the settings. Instead of islanding, the CES rode through these short voltage sag events. However, the CES has also islanded incorrectly on one occasion. The CES vendor has acknowledged that the CES does occasionally incorrectly detect grid outages, which causes it to island. The vendor is working on a solution. When this happened with the ISGD CES, it returned to grid-connected mode within two minutes of disconnecting.

The ISGD team will continue to monitor the CES alarms to determine whether it continues to incorrectly identify grid outages. Once the vendor provides a firmware solution to this improper islanding issue, the team will then close the load connection switch and open the bypass switch. The CES will then be capable of providing islanding support in the event of future grid outages.

4.1.1.4.6 Field Experiment 1F: Impact of Solar PV on the Grid

Test 1: RESU PV Grid Impact (March 1, 2014 to October 31, 2014)

Figure 60 summarizes the solar output for each ISGD home over the eight-month period between March 1, 2014 and October 31, 2014. The solar output showed considerable variation throughout the year, with lower amounts during the spring and fall months, and higher output during the summer. Variations also exist between the various project homes. The section below this table explores the potential sources of this variation.

Figure 60: Solar PV Generation by Month (March 2014 through October 2014)

Project Home	Solar PV Generation by Month (kWh)								
	Mar. '14	Apr. '14	May '14	Jun. '14	Jul. '14	Aug. '14	Sep. '14	Oct. '14	Total
ZNE 1	561	683	729	727	667	694	572	472	5,105
ZNE 2	577	701	743	746	688	712	596	503	5,266
ZNE 3	376	460	488	581	685	710	587	488	4,375
ZNE 4	545	677	729	730	666	688	558	458	5,051
ZNE 5	535	639	681	688	601	648	540	447	4,779
ZNE 6	577	697	737	726	661	706	585	489	5,178

²² Rule 21 specifies the disconnection time requirements for grid events such as under/over voltages and frequency excursions for generating facility interconnections to SCE’s distribution system.

Project Home	Solar PV Generation by Month (kWh)								
	Mar. '14	Apr. '14	May '14	Jun. '14	Jul. '14	Aug. '14	Sep. '14	Oct. '14	Total
ZNE 7	540	657	695	688	625	650	542	347	4,744
ZNE 8	550	680	651	711	664	694	568	465	4,983
ZNE 9	574	692	718	710	655	674	554	505	5,082
RESU 1	585	713	762	770	699	725	612	496	5,362
RESU 2	326	438	579	577	525	493	361	312	3,611
RESU 3	389	593	625	619	572	584	498	417	4,297
RESU 4	326	438	579	577	525	493	361	312	3,611
RESU 5	431	550	589	556	542	539	447	331	3,985
RESU 6	238	286	298	410	525	597	484	406	3,244
CES 1	489	630	673	666	608	652	570	479	4,767
CES 2	424	553	616	620	567	639	537	430	4,386
CES 3	482	581	623	600	537	568	482	395	4,268
CES 4	550	640	669	651	599	655	580	481	4,825
CES 5	493	623	674	666	609	647	518	355	4,585
CES 6	469	630	674	673	611	649	548	435	4,689
CES 7	527	632	664	666	609	646	560	468	4,772
Totals	10,564	13,193	14,196	14,358	13,440	14,063	11,660	9,491	100,965

In June 2013, the ISGD team performed an analysis of the solar PV output of on the ZNE and RESU blocks. The solar PV on these two blocks share an inverter with the RESUs at each respective home. The purpose of this analysis was to assess the homes' solar PV output over time and across all the project homes. **Figure 61** summarizes the solar PV output for each home between October 2013 and May 2014. The chart reveals considerable variation in output between the homes, and between the months—with lower output during the winter months.

Figure 61: Average Solar PV Output (October 2013 to May 2014)

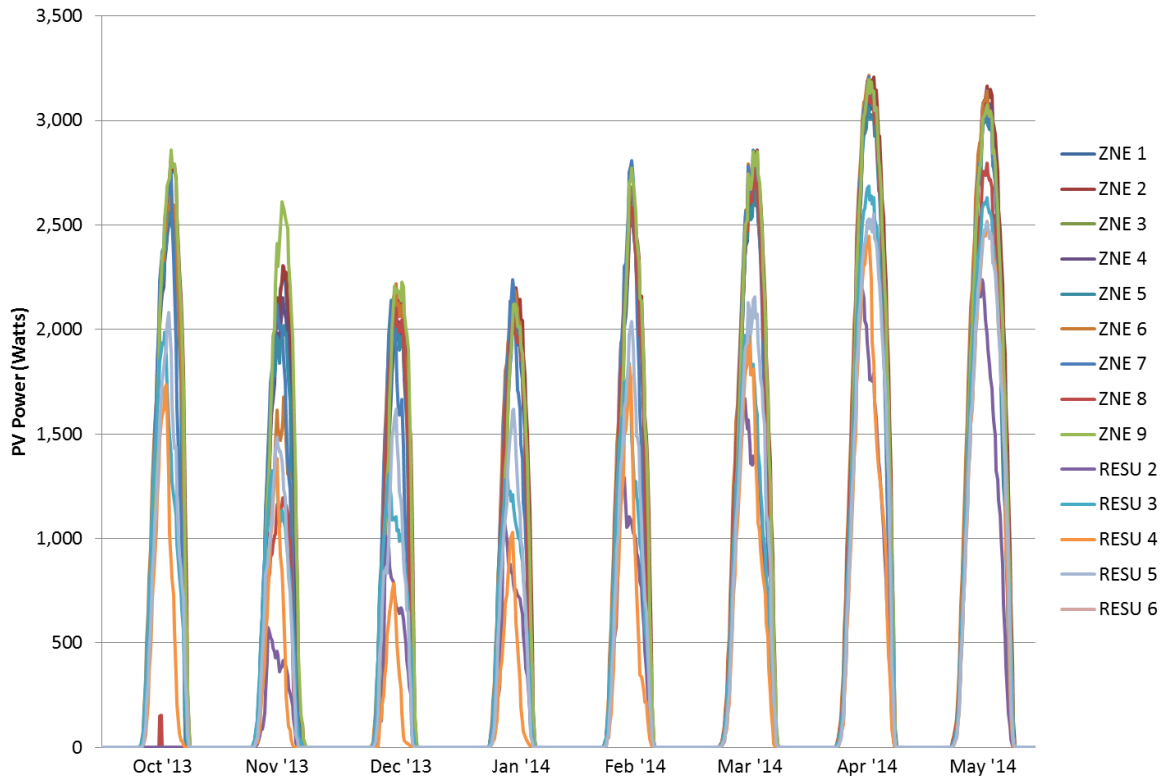

While performing this analysis of the PV output, the team discovered that three of the solar installations were generating less than their peak design capacities. By May 2014, shading that had limited the solar PV output in the winter months had disappeared. However, the output of ZNE 3, RESU 2, and RESU 6 remained well below their expected production levels. **Figure 62** summarizes the output of each homes on June 17, 2014. The output of these three homes is well below the other homes. The team suspected that the reduced RESU 2 output was due to afternoon shading. Its output peaked at around noon and then declined more sharply than the other homes in the afternoon. This suggested that perhaps the problem with RESU 2 was not due to wiring or other technical issues. The team suspected there might be technical issues with the other two homes, ZNE 3 and RESU 6.

Figure 62: Solar PV Generation (June 17, 2014)

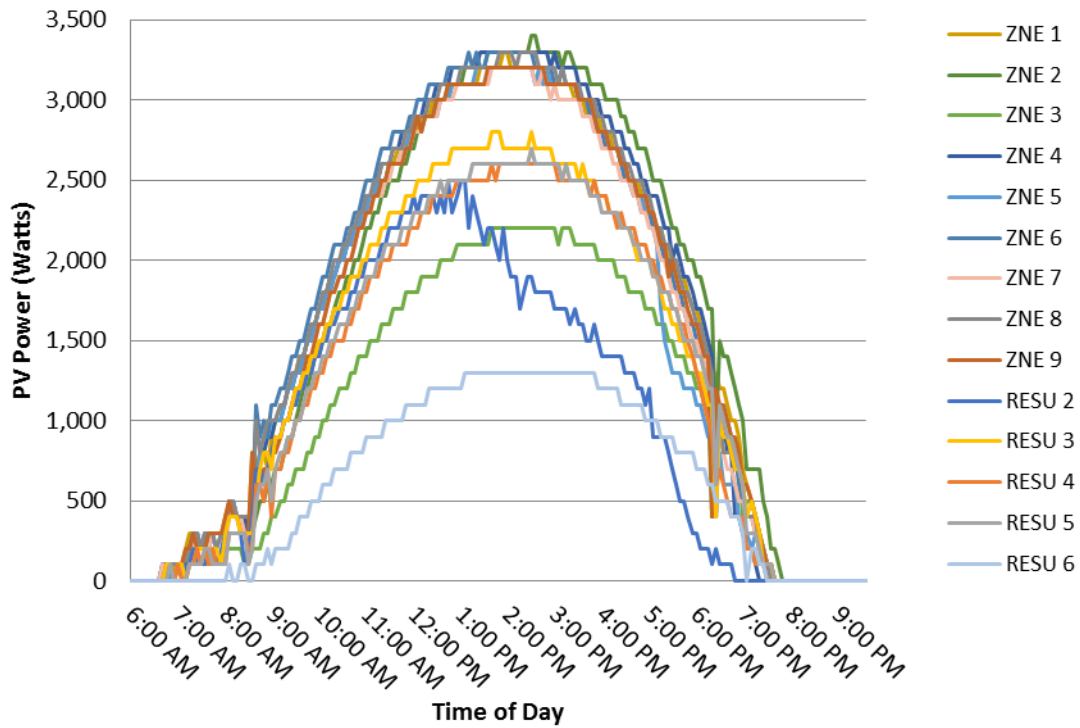

The team conducted an on-site visit to ZNE 3 and RESU 6 on June 20, 2014, and discovered problems with the electrical connections of the homes' PV equipment. ZNE 3 had a bad electrical connector, which the team replaced. At RESU 6, the team discovered fuses inside the PV combiner box were not properly placed in service during the installation process. The solar PV output of both of these homes immediately improved after fixing these two installations. **Figure 63** shows that the output of these two homes was consistent with the other homes following the repairs.

Figure 63: Solar PV Generation (July 22, 2014)

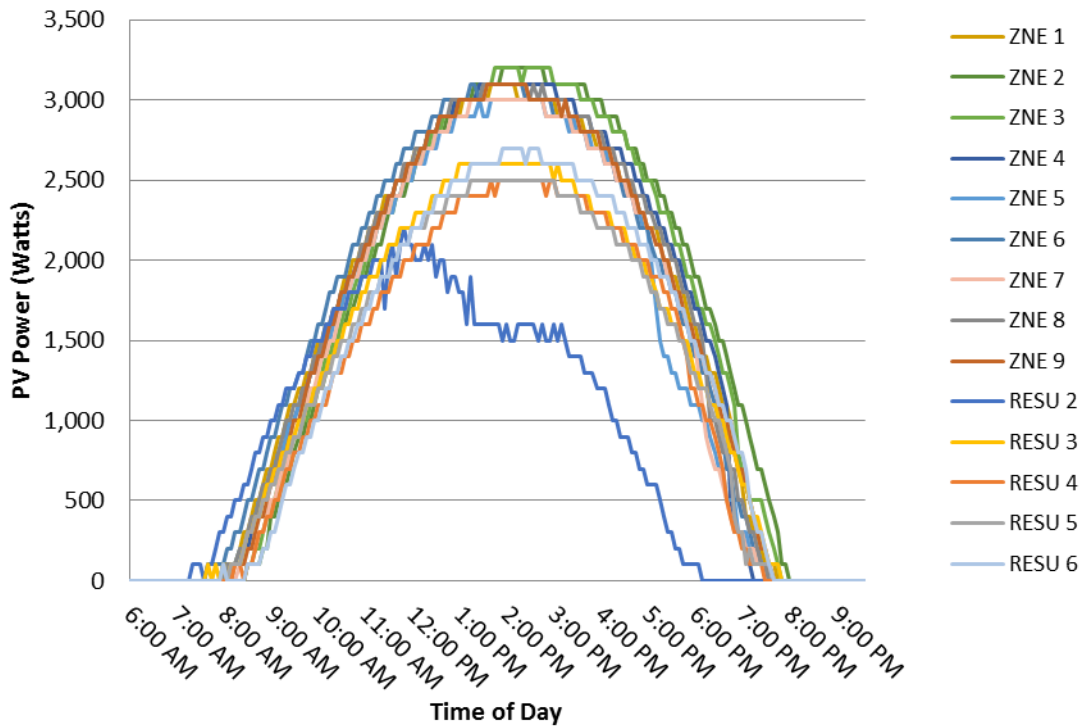

The solar output of RESU 2 remained poor in the summer season. The ISGD team verified that this was due to shading of the solar array. This home had been producing 20-30% less energy than its neighboring systems before this issue was resolved.

4.1.1.4.7 Field Experiment 1G: EVSE Demand Response Applications

The team performed five DR events using EVSEs during the timeframe covered by this report. Each of these DR events used multiple HAN devices including the PCTs, RESUs, and smart appliances. The results of these tests are summarized in section 4.1.1.4.2 above.

Over the past several months, the ISGD team has worked with BTC Power, the project’s EVSE vendor, to resolve more than 20 software and hardware problems with the units used in both sub-project 1 and sub-project 2. Although most of these issues related to EVSE operation, in three instances the EVSEs have posed an electrical hazard by demonstrating excessive heat buildup that resulted in heat damage on both wires and terminal blocks. These three cases occurred with three different EVSEs, all located within the parking structure. These events occurred on June 2, 2014, October 14, 2014, and October 21, 2014. The team determined the cause of the first event and resolved it within a few days. Following the third event, the manufacturer performed a root cause analysis and determined that the cause was likely due to over-torqueing the wires (i.e., tightening the wires too tightly). The manufacturer has stated that this over-torqueing was due to a discrepancy between the torqueing specification listed on the contactor specification sheet and the specification printed on the contactor device.

Based on the continued problems with these devices, and the fact that three of these incidents had the potential to impact safety, the ISGD team decided to disable all the ISGD EVSEs and to replace them with different EVSEs. The team has selected two new replacement models, one for the ISGD homes (sub-project 1) and another for the parking structure (sub-project 2). The team completed all the EVSE replacements in December 2014.

Field Experiment 1H: EVSE Sub-metering

The project team monitored and collected PEV charging activity through separately metered EVSE usage. **Table 38** summarizes the aggregate PEV charging activity for the 8 months covered by this report.

Table 38: Sub-metered PEV Charging Activity

Usage Metric	EVSE Charging Activity by Month (kWh)								
	Mar. '14	Apr. '14	May '14	Jun. '14	Jul. '14	Aug. '14	Sep. '14	Oct. '14	Total
Average Home	85.6	86.0	87.9	89.7	85.4	80.1	91.0	94.8	700.5
High Home	324.9	385.7	383.7	288.4	339.6	317.4	307.8	365.6	
Low Home	10.8	11.2	11.0	10.8	11.4	11.3	10.9	11.0	
All Homes	1,882.8	1,891.5	1,934.5	1,973.2	1,878.9	1,762.5	2,003.0	2,084.6	15,410.9

4.1.1.5 Impact Metrics and Benefits Analysis

The Final Technical Report will address the impact metrics and benefits, to allow sufficient time for the project team to accumulate sufficient data and perform the necessary analyses.

4.1.2 Sub-project 2: Solar Car Shade

The solar car shade consists of an array of solar panels on the roof of a parking structure on the UCI campus, a BESS, and 20 electric vehicle chargers. The various system components were deployed between July and November 2013, and field experimentation began in December 2013. This section summarizes the lab testing, commissioning tests and field experiments used to assess this system.

4.1.2.1 Laboratory Tests

The first TPR summarizes the results of the BESS and EVSE laboratory testing.

4.1.2.2 Commissioning Tests

The first TPR summarizes the results of the BESS commissioning testing.

4.1.2.3 Field Experiments

Figure 64 depicts the configuration of the various solar car shade components. The 20 EVSEs are at the lower right, while the converter, battery, and PV systems are at the lower left (collectively referred to as the BESS). The EVSEs and BESS components connect to the grid at the top. Dedicated 480 V 3-phase meters measure each of these three connections (indicated by the red dots).

Figure 64: Solar Car Shade System Overview

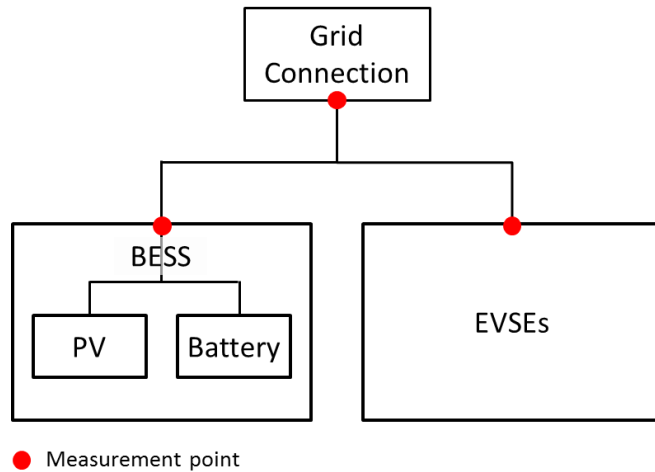

Table 39 summarizes the measurement points and sign conventions.

Table 39: Solar Car Shade System Measurement Points

Measurement Point	Measurement Source	Sign Convention
Grid Connection	Dedicated 480 V 3-phase meter (1 for each measurement point)	(-) generation (+) load
BESS		
EVSE		
Battery	Inverter internal dc (one for each measurement point)	(-) discharging (+) charging
PV		

The field experiments are discussed below. In addition to those experiments, the team is also monitoring the overall performance of the entire Solar Car Shade system in terms of the energy used for electric vehicle charging and the electricity production of the solar PV arrays. **Table 40** summarizes the Solar Car Shade performance from deployment through October 31, 2014.

The battery system was installed and operational in September 2013, the PV was installed in early November 2013, and the EVSEs were made available to the public for PEV charging in December 2013. Electric vehicle charging varied depending on the school schedule (summer session versus fall, winter, and spring quarters), and it increased noticeably at the beginning of the fall 2014 quarter. Similarly, the values measured at the BESS connection to the grid changed with the season due to the effects of sun angles and weather on the solar PV generation. Finally, the values in all three columns of **Table 40** are measured by three separate meters, so the sum of the first two columns does not precisely equal the third column.

The total row indicates that from September 2013 through October 2014, electric vehicle charging consumed 43 MWh while the BESS supplied 45 MWh from PV energy, for a net surplus of 2 MWh supplied back to the UCI grid. This surplus is expected to turn into a deficit as electric vehicle charging increases and PV generation decreases over the winter.

Table 40: Solar Car Shade System Performance

<ul style="list-style-type: none"> • Values are in ac kWh • Negative values indicate generation, positive values load 		EVSE	BESS	Solar Car Shade Grid Connection
2013	September	0	1,398	1,382
	October	0	1,669	1,690

<ul style="list-style-type: none"> • Values are in ac kWh • Negative values indicate generation, positive values load 		EVSE	BESS	Solar Car Shade Grid Connection
	November	289	(424)	(116)
	December	1,539	(1,023)	571
2014	January	2,977	(1,356)	1,662
	February	2,893	(2,973)	(45)
	March	3,164	(3,405)	(306)
	April	4,363	(4,464)	12
	May	3,946	(5,935)	(1,964)
	June	3,779	(6,731)	(2,994)
	July	3,624	(6,234)	(2,572)
	August	4,237	(6,711)	(2,414)
	September	4,942	(5,232)	(397)
	October	7,097	(3,805)	3,520
Totals		42,850	(45,226)	(1,971)

As discussed above in section 4.1.1.4.7, the team disconnected these EVSEs in October and replaced them with EVSEs from a different manufacturer during December 2014.

4.1.2.3.1 Field Experiment 2A: Minimize Peak Period Impact of PEV Charging

The solar car shade did not operate in this mode during the timeframe covered by this report. It will likely operate in this mode during the final reporting period. The Final Technical Report will summarize the results of this field experiment.

4.1.2.3.2 Field Experiment 2B: Cap Demand of PEV Charging System

The solar car shade did not operate in this mode during the timeframe covered by this report. It will likely operate in this mode during the final reporting period. The Final Technical Report will summarize the results of this field experiment.

4.1.2.3.3 Field Experiment 2C: BESS Load Shifting

Test 1: April 23, 2014 to October 31, 2014

To perform this experiment the team operated the BESS in a permanent load shift mode in conjunction with PV generation, and quantified the ability of the system to shift energy between on and off-peak periods. The team configured the system to charge at night and discharge during the day using constant power charge/discharge set points. This schedule effectively offset on-peak load with off-peak energy. This operation did not address the dynamic nature of EV charging, but it reduced the overall energy consumption of the charging station from the grid (through PV generation) and it also reduced on-peak demand. The BESS was operational and the EVSEs were available for use by the UCI general population throughout the experiment period, excluding occasional maintenance, troubleshooting, and tour activities. These troubleshooting issues are described in more detail below.

The team programmed the BESS's Site Controller with the following schedule to carry out this experiment:

- Monday through Saturday starting at 12:00 am, charge the BESS from the grid at a power level of approximately 20 kW. This includes 2 kW to operate the BESS, so the net power used to charge the battery is 18 kW. Charge the battery until the charge tapers back and reaches 100% SOC, then continue to draw grid power to operate the BESS.

- Every day starting at 6:00 am, supply all available solar PV output to the main BESS connection, where the power will either power the EVSEs (if there are electric vehicles charging), or feed back to the grid. This solar PV output will also power the BESS (2 kW). If the solar PV is insufficient, the BESS will operate using grid power.
- Monday through Friday starting at 12:00 pm, provide approximately 45 kW of combined power from the solar PV and BESS to power the EVSEs. If the EVSE load is less than 45 kW, the excess power will feed back to the grid. The BESS will modulate its discharge rate based on the solar PV output in order to maintain a combined power level of 45 kW between the BESS and solar PV.

EVSE loads do not affect the BESS discharge rate. However, solar PV generation does affect the BESS discharge rate. The BESS discharge rate changes based on solar incidence (sun angles and weather) and the efficiency of the solar PV array (temperature and dirt buildup). Greater levels of solar PV generation decreases the BESS's discharge rate after 6:00 am, and extends the discharge time of the battery past 12:00 pm on weekdays—since more solar PV generation reduces the battery rate of discharge in order to maintain 45 kW of combined solar PV and BESS power.

Figure 65 presents the BESS power profile on October 28, 2014. This represents the typical weekday power profile as measured at the Solar Car Shade, main BESS (including battery and PV), and EVSE ac connections. This profile includes the 20 kW load/charge starting at 12:00 am, PV generation starting at 6:00 am, and the constant 45 kW output starting at 12:00 pm. This figure also includes solar PV generation (measured in DC) and battery SOC.

Figure 65: BESS Weekday Power Profile (October 28, 2014)

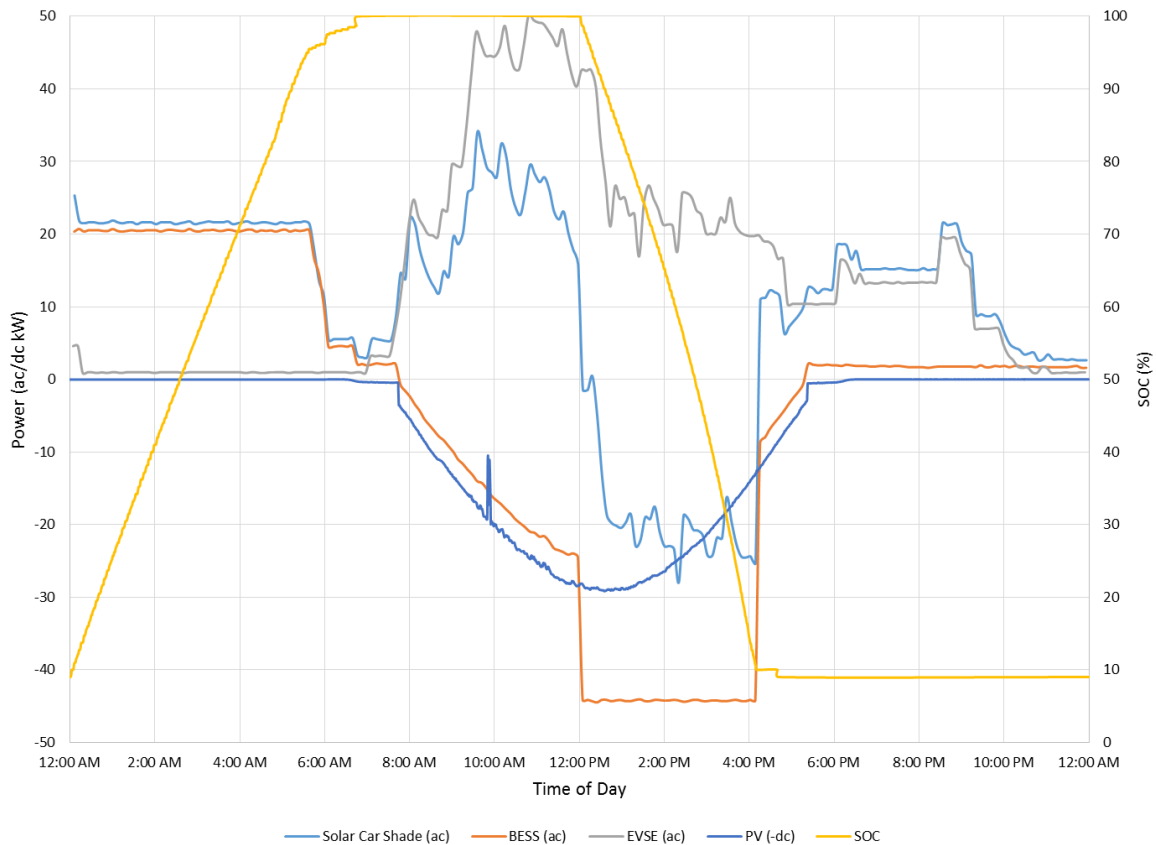

In general, the Solar Car Shade is the sum of the BESS and EVSE. However, since the actual values come from three separate meters, this relationship is approximate. **Figure 65** demonstrates the system's ability to shift energy by

charging the battery during an off-peak period (from 12:00 am to approximately 6:00 am at 20 kW), and discharging during an on-peak period (from 12:00 pm to approximately 4:00 pm). The solar PV generation during the discharge period has the effect of extending the discharge time. At 45 kW, the 100 kWh battery takes a little over two hours to discharge. However, the solar PV generation causes the battery's rate of discharge to decrease, which extends the discharge duration. In this example, the solar car shade's solar PV generation varies from 12 kW to 29 kW during the discharge, and extends the battery by approximately two hours.

This figure also demonstrates the system's ability to decrease on-peak demand. Without the BESS (including the solar PV), the Solar Car Shade would have the same load profile as the EVSE. However, the BESS's daytime solar PV generation reduces the morning peak of the Solar Car Shade, while the afternoon solar PV generation and battery discharge creates a net surplus of generation, which feeds back to the grid. Only after the battery is discharged does the constant 45 kW generation stop. Once the battery stops discharging, the solar PV generation continues for approximately one more hour, helping to offset the Solar Car Shade load. Once the PV generation stops, the Solar Car Shade load profile matches the EVSE plus BESS auxiliary loads.

Figure 65 demonstrates the limitations of a constant power-based schedule, which does not address the dynamic nature of EVSE load. Even though the system reduced peak demand and shifted energy from on to off-peak periods, the overall Solar Car Shade load profile continued to vary with EVSE load. Similarly, the constant power, time-based discharge, in addition to the finite battery capacity, resulted in the Solar Car Shade generating power between 12:00 pm and 4:00 pm, but then consuming power for the rest of the evening and night. If the battery capacity was larger or the schedule was adjusted to decrease the afternoon discharge power to more closely match EVSE load, the discharge period would have been longer and further reduced the demand of the Solar Car Shade on the grid. More sophisticated control strategies such as load smoothing or cap demand (which will be evaluated as part of this demonstration)—or more intelligent algorithms capable of adjusting timing and thresholds based on past behavior—would help to improve the overall performance and value of the BESS in supporting the Solar Car Shade.

Over the course of this experiment, which lasted more than six months, the BESS experienced four failures and had 244 hours of down time and nine hours of maintenance time. Two of the failures related to internal safety faults designed to protect the system when inverter/battery exceeds operational thresholds. In both cases, the fault conditions were transient and the team had seen them before. Based on experience operating the system and recommendations from the integrator, the team reset the inverter and battery, which then resumed operation. Together, these failures resulted in 108 hours of down time, reflecting the time it took an engineer to schedule a visit to the BESS, confirm the issue, and restart the system. These types of failures relate to the integration of the various system components, and highlight the importance of ensuring subsystem compatibility and safety through integrator experience and extensive pre-deployment testing.

Another failure related to incorrect instantaneous trip settings on the main AC circuit breaker feeding the BESS. The team was aware of this issue before the start of the experiment, as it had previously caused multiple nuisance trips. However, the team believed they could perform the experiment with the existing trip settings due to the specific operating schedule of the BESS and associated current inrush during daily inverter startup. This allowed the experiment to proceed while the team performed a coordination study to determine new trip settings. Once the new trip settings are in-place, this type of failure should not reoccur. This failure resulted in 50 hours of down time, reflecting the time it took an engineer to schedule a visit to the BESS, confirm the issue, and restart the system. This failure demonstrates the importance of ensuring all protective devices (e.g., circuit breakers) are coordinated and adjusted appropriately for the load during installation, rather than retaining their manufacturer default settings.

The final failure was a loss of communication with the BESS, preventing remote status checks, control, or data transfer. Throughout the communication loss, the BESS continued to operate as programmed, so this failure did not contribute to the hours of down time metric. The team resolved this issue by visiting the BESS and restarting the system's internal 4G cellular radio and router.

The remaining down time was due to an engineer incorrectly logging off from the BESS's Site Controller computer during a routine status check. This caused the control software to close, and a subsequent BESS trip. The system remained in this state over the weekend, and then another engineer remotely reset and restarted the system 66 hours later. This issue demonstrates a disadvantage of using a consumer/commercial-off-the-shelf approach to system integration. In this case, the manufacturer chose to run their system control software on an embedded computer running a standard version of Windows 7. This approach makes it simple to inadvertently log off from the embedded computer rather than disconnecting from remote desktop sessions. If the system integrator had customized Windows to prevent logging off, or had used an always-on industrial embedded control system to operate the BESS, this type of issue would be less likely to occur.

The nine hours of maintenance time was due to safety tours and checks of the BESS, as well as short pauses in the experiment to manually operate the BESS as part of power quality testing. The power quality testing resulted from issues with the EVSEs, where certain PEV makes/models were unable to charge. This behavior was due to electrical noise on the EVSE pilot signal (a form of communication between the PEV and EVSE), originally thought to originate from the BESS inverter's power electronics. This issue was investigated over multiple trips to the site, including engineers, power quality experts, and the EVSE manufacturer. Finally, the power quality expert discovered that the two transformers feeding the EVSEs from the Solar Car Shade System's main panel had been grounded incorrectly during installation. This resulted in high levels of electrical noise on the secondary side of the transformers, which was carrying over to the EVSE pilot signal. While most PEVs could charge with the noise present, some PEVs were more sensitive and refused to charge. Once the team properly grounded the transformers, the electrical noise diminished and all PEVs could charge normally.

4.1.2.4 Impact Metrics and Benefits Analysis

The Final Technical Report will address the impact metrics and benefits, to allow sufficient time for the project team has accumulate sufficient data and perform the necessary analyses.

4.2 Next-Generation Distribution System

4.2.1 Sub-project 3: Distribution Circuit Constraint Management Using Energy Storage

This sub-project is demonstrating a mobile, containerized DBESS that will be used to help prevent load on the distribution circuits from exceeding a set limit. The DBESS will also be used to mitigate overheating of the substation getaway. The team moved the DBESS from its original location at one of SCE's energy storage laboratories to the field in March 2014, and first connected it to the grid on April 15, 2014. This section summarizes the laboratory testing performed on the DBESS prior to field deployment, as well as the commissioning activities after its move to the field. The Final Technical Report will summarize the results of the field experiment activities for Sub-Project 3. Since the DBESS's commissioning, the team has operated it to support Sub-project 6: Deep Grid Situational Awareness (see section 4.2.4).

4.2.1.1 Laboratory Testing

In December 2009, SCE acquired two 2-MW/0.5 MWh grid battery systems to gain firsthand experience with the operation and performance of large transportable energy storage devices. One of these battery systems was later relocated to Irvine to be used for the ISGD DBESS experiments. SCE intended to use the DBESS for various applications on its distribution system, including distribution feeder relief.

SCE performed an extensive evaluation under a tightly controlled environment at its facilities in Westminster, California. Based on these evaluations, the system was effective in reducing circuit overloads by automatically and

continuously injecting or absorbing energy. The monitoring equipment and control algorithm used to implement the feeder relief function performed as expected.

4.2.1.2 Commissioning Tests

The team relocated the DBESS to the field in March 2014. Between March and April, the DBESS's battery and battery management system trays were inspected and reinstalled in the battery racks (originally removed for transportation), and the mechanical and electrical connections between the auxiliary equipment skid and battery/inverter container were reconnected. The auxiliary skid was also connected to the new interconnection equipment installed at the site, which serves as the interface between the utility distribution circuit and the DBESS.

The team first connected the system's auxiliary skid to the grid on April 15, 2014. Project engineers then energized the DBESS's auxiliary power circuits and verified the operation of all supporting systems throughout the auxiliary skid and battery/power conversion system (PCS) container, including the chiller, in-row air conditioners, dehumidifier, control system HMI, control system PLC, battery management system, control system uninterruptible power supplies, fire suppression system, primary lighting system, and emergency lighting system. After checking all auxiliary systems against manufacturer installation, operation, and maintenance manuals, the team closed the DBESS's primary power circuit disconnects and circuit breakers. The team then started the DBESS, including closing the battery rack contactors and synchronizing the PCS with the grid.

Over the following several weeks, the team operated the system manually through several charge/discharge cycles to help balance the battery racks and verify the overall operation of the system. During this time, the team installed a power quality monitoring (PQM) system between the interconnection equipment and auxiliary skid to locally record the system's actual real and reactive power dispatches in support of sub-projects 3 and 6. The team also installed an industrial 4G cellular radio to connect the PQM with the project's pilot production network and allow for remote data access.

Other commissioning activities included the installation of a mobile office for local operation and maintenance visits, development of a site-specific safety policy, and a PCS output calibration by the manufacturer (which increased the real power dispatch accuracy of the control system). The DBESS was ready for experimentation by September 18, 2014.

4.2.1.3 Field Experiments

4.2.1.3.1 Field Experiment 3A: Peak Load Shaving/Feeder Relief

The DBESS did not operate during the timeframe covered by this report. It will operate in this mode during the final reporting periods. The Final Technical Report will summarize the testing results.

4.2.1.4 Impact Metrics and Benefits Analysis

The Final Technical Report will address the impact metrics and benefits, to allow sufficient time for the project team to accumulate data and perform the necessary analyses.

4.2.2 Sub-project 4: Distribution Volt/VAR Control

During the period covered by TPR 1, the team completed the simulations, laboratory testing and system integration activities, leading to the successful implementation of DVVC on the ISGD DMS in January 2014.

During the period covered by this second TPR—March 1, 2014 through October 31, 2014—the team successfully operated the system. A number of issues involving the electric system under DVVC control arose during this period. For example, SCE Grid Operations inadvertently transferred some circuits to a different substation operating bus, and some circuit capacitors were temporarily out of service. These issues brought the early field

experiment results into question. The last of these issues was not resolved until early October 2014. Nevertheless, the qualitative performance of the DVVC met the team's expectations, with the system producing lower overall voltages of approximately 1.5 to 2 volts (on a 120 volt base) while operating in CVR mode. An average reduction of 1.75 volts (or 1.45%) and a CVR factor of 1.0 translates into energy savings of approximately 1.45%. The team will refine its analysis over the remainder of the project.

4.2.2.1 Simulations

The team performed simulations of the substation operating bus and seven circuits under DVVC control using a representative set of circuit loading conditions. The simulation results confirmed the DVVC design.

4.2.2.2 Laboratory Testing

The team performed both factory and site acceptance testing, as reported in the first TPR, confirming the successful integration of DVVC, ISGD Distribution Management System, and all field components.

4.2.2.3 Commissioning Tests

The DVVC application became operational at MacArthur Substation in January 2014 for the team to experiment with the volt/VAR control set points. The team monitored the distribution system's behavior closely, and adjusted the set points when appropriate. To assess the reliability of radio communications for the DVVC algorithm's control signals, the team also monitored the Netcomm Radio system. The DVVC application's logic was determined to be successful during these field tests. The overall impact on average system voltage was also consistent with the team's expectations.

4.2.2.4 Field Experiments

The ISGD team began operating the DVVC algorithm in January 2014. The first TPR stated that the preliminary results indicated that it was performing as expected.

This second TPR covers the period from March 1, 2014 through October 31, 2014. The team operated the DVVC application throughout this period and it performed as expected. However, a number of unexpected issues arose that affected the testing. These issues included the loss of the substation current transformer (CT) from March 21 through May 30, the unavailability of the substation and some field capacitors for much of the period, and periods in which one or more of the circuits under DVVC control were mistakenly transferred to the bus not under DVVC control. As a result, the system operated in its intended configuration for only four weeks, between October 3 and October 31, 2014.

Despite these difficulties, the system performed largely as expected. The DVVC application was turned on and off for alternate weeks throughout the eight month period, always in the CVR mode. Voltages both at the substation bus and on a sample of customer AMI meters were approximately two volts lower (and with fewer fluctuations) when DVVC was operating.

4.2.2.4.1 Field Experiment 4A: DVVC VAR Support

The VAR support mode of operation is an abnormal mode that would only be useful under limited circumstances. The team would only operate DVVC in this mode if the sub-transmission system's reactive power needs are urgent enough to have the distribution system supply VARs to it. This would require having more capacitors on line, which would in turn require operating the distribution system near the upper range of ANSI C84.1 voltages. **Figure 66** shows the VAR and voltage levels on one of the MacArthur Substation busses on February 7, 2014, when DVVC operated in the VAR support mode. For this test, the maximum voltage was set at 125 volts on a 120 volt nominal basis. As voltage is raised from 122.5 to 125 volts, the reactive power flow changed from 4 megavolt-amperes reactive (MVAR) flowing into the substation to 5 MVAR flowing out of the substation into the sub-transmission

system. Owing to the electric system configuration issues mentioned in section 4.2.2, the team will provide more quantitative analysis in the Final Technical Report.

Figure 66: VAR Support Mode (February 7, 2014)

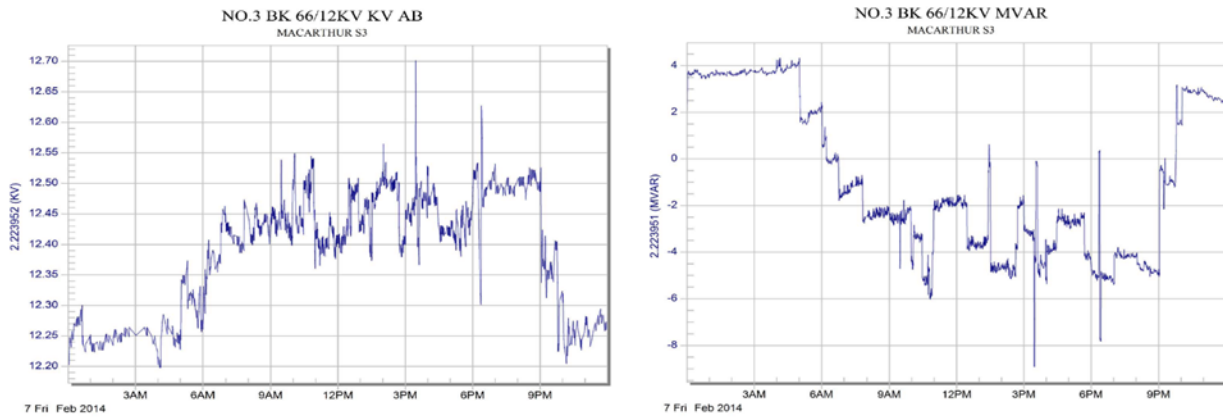

4.2.2.4.2 Field Experiment 4B: DVVC Conservation Voltage Reduction

DVVC began operating in CVR mode on alternate weeks beginning in January 2014. During the weeks when DVVC was off, the individual capacitors were set to operate autonomously with appropriate settings. When DVVC was on, the individual capacitor voltage settings were set to not interfere with DVVC operation, but to act as backups if voltage became too high or low. **Figure 67** shows the voltage on a MacArthur Substation bus over approximately four weeks. DVVC operated in CVR mode on periods between February 17, 2014 and March 21, 2014, resulting in a clear voltage reduction compared with the weeks immediately before and after (when DVVC did not operate). The SCADA system used for this graph takes data at four-second intervals. Fluctuations also seem to decline when DVVC is on. Owing to the electric system configuration issues addresses in 4.2.2, the Final Technical Report will provide more detailed quantitative analysis of DVVC’s CVR capability.

Figure 67: Substation Bus Voltages with DVVC in CVR Mode (February 15, 2014 to March 15, 2014)

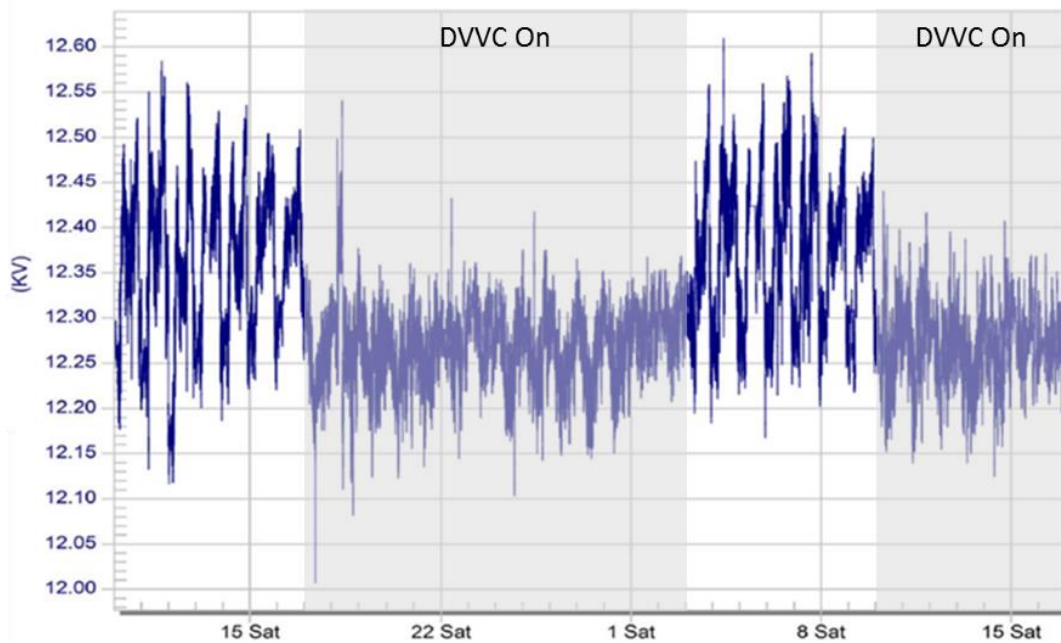
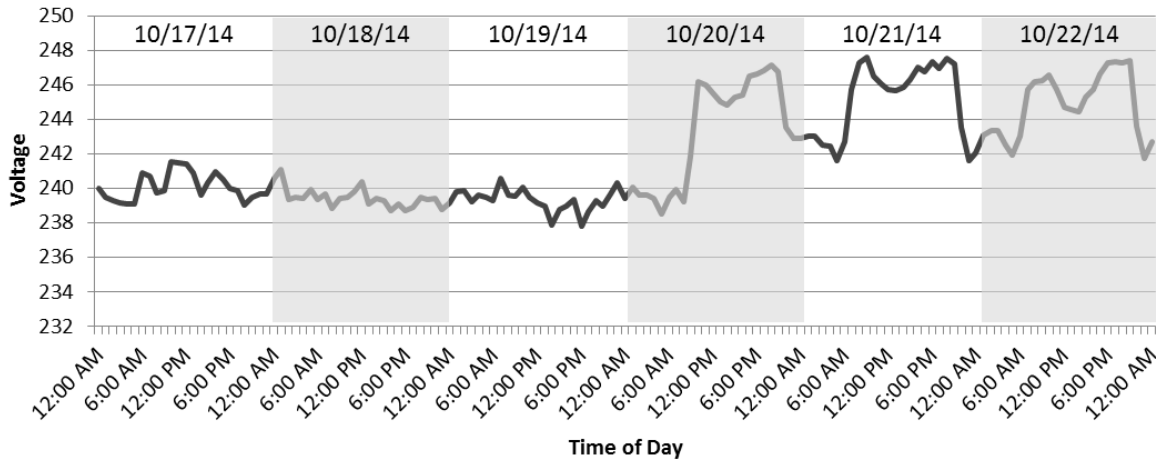

Figure 68 provides the voltages from an AMI meter over a six-day period. DVVC was turned on for three days (October 17, 2014 to October 19, 2014), and turned off for three days (October 20, 2014 to October 22, 2014). These meters are capable of capturing the average voltage value for each hour. This figure reveals material reductions in both the absolute voltage levels and voltage variability.

Figure 68: Customer Voltages with and without DVVC (October 17, 2014 to October 22, 2014)



Once the circuit anomalies mentioned in section 4.2.2 were rectified in early October 2014, the team obtained voltage and energy consumption data for two sets of alternate on-off weeks. For each week, the team averaged all of the voltage readings from the 14 field capacitors (one capacitor was out of service) and the substation bus. **Table 41** summarizes the results of these on/off periods.

Table 41: DVVC CVR Results (October 6, 2014 to November 10, 2014)

Time Period	DVVC	Average Voltage	Energy kWh	CVR ($\Delta\text{kWh\%}/\Delta\text{V\%}$)
Oct 6 – Oct 13	Off	121.8	4,009,010	5.7/1.5=3.6
Oct 13 – Oct 20	On	120.0	3,780,000	
Oct 28 – Nov 3	On	119.8	3,068,990	3.2/1.96=1.6
Nov 4 – Nov 10	Off	122.2	3,172,990	

The average CVR factor for these two test periods is 2.6, which is much higher than the team’s expected 1.0 (based on SCE’s results with DCAP), as well as the 0.4 to 1.0 range mentioned in the EPRI survey of 52 utilities²³. The team did not perform weather adjustments for the weekly comparisons, and two periods on only seven circuits is a small sample compared to the 172 circuits measured in the DCAP program. The team has not reached any conclusions about the impacts of DVVC. The above information for information purposes only.

The team made a few observations during this initial period of operating DVVC. A system such as DVVC is operates on a substation bus and all of the circuits connected to that bus. If one circuit has chronically low voltage near its end, that low voltage point acts as a constraint on what the DVVC can do for the rest of the system. Actions to correct such weak spots could free the DVVC to achieve greater overall results. For example, siting a line regulator or smaller capacitor bank closer to the end of the line could increase end-of-line voltages without increasing voltage levels on the rest of the circuit.

²³ Volt-VAR Optimization Survey Summary presentation, March 15, 2012.

The configuration of circuits in the MacArthur Substation in support of the ISGD project is maintained manually. There is no automatic updating of the DVVC when operators switch a circuit from one bus to another. Inevitably, required notifications will sometimes fail when human action is required. A full implementation should link the DVVC to the substation EMS-SCADA system so that DVVC is aware of configuration changes when they occur.

VVO schemes such as DVVC and IVVC can result in significant energy savings. They work best when careful attention has been given to establishing proper voltage schedules, transformer tap settings, and circuit design.

4.2.2.5 Impact Metrics and Benefits Analysis

The Final Technical Report will address the impact metrics and benefits, to allow sufficient time for the project team has accumulate sufficient data and perform the necessary analyses.

4.2.3 Sub-project 5: Self-healing Distribution Circuits

This project is demonstrating a self-healing, looped distribution circuit that uses low-latency radio communications to locate and isolate a fault on a specific circuit segment, and then restore service once the fault is removed. This protection scheme is designed to isolate the faulted circuit section before the substation breaker opens (typically 670 milliseconds after a fault). This functionality should lead to improved distribution circuit reliability by reducing the number of customers exposed to momentary outages and easing the circuit restoration burden on system operators.

4.2.3.1 Simulations

The team performed simulations to determine the maximum load levels for which looped operation is appropriate. Additional simulations helped to verify the fault isolation logic and timing for a wide range of operating conditions. The simulations included various fault scenarios at different locations on the Arnold and Rommel 12 kV distribution circuits. They also included different types of faults at each location (all combinations of phase to ground, phase to phase, double phase to ground, and a three-phase fault). Faults were simulated at each section of load between the protection relays to verify that they operate correctly. The team performed these simulations using SCE's RTDS with the actual protective relay inputs and outputs attached to the simulator for closed loop testing. Outputs from the RTDS were physically connected to four Schweitzer Engineering Laboratories (SEL) 651Rs and two GE F60 relays.

The team reviewed all event files and oscillography files when the simulations produced an undesired outcome. These files helped the team to troubleshoot the protection logic. When changes were required for the protection settings, the team repeated all the testing.

The simulation testing was successful in validating the system protection scheme, and helped the team identify the need for a few modifications to the protection settings. The biggest issues were false tripping under heavy-load conditions, box loops around URCl (which effectively bypasses the URCl), and clearing end-of-line faults. To address the heavy-load issue, the team decided that if the circuit loading exceeds 600 amps (i.e., the combined loading of the two looped circuits), then the Arnold and Rommel circuits would be de-looped to prevent both circuits from tripping. In the event that a box loop forms around a URCl, the two circuits would be de-looped to minimize the number of customers affected by the fault. The last issue related to end-of-line faults. The protection scheme required six seconds to clear a three-phase fault at the end of the line. To resolve this issue the team reduced the trip settings on two of the URCl.

4.2.3.2 Laboratory Testing

The team assembled and tested the relays and radios as a system prior to field installation to verify that they function and perform properly. They imposed actual circuit fault conditions (derived from simulation tests) on the assembled laboratory test setup, and recorded the protection scheme responses. High-speed communications

system performance was also verified in the laboratory. The team also evaluated the SA-3 system's ability to coordinate with the URCI protection scheme.

The team did not test the URCI protection scheme by inducing actual faults on live circuits since this would require a service interruption for SCE customers. The team conducted laboratory testing in lieu of field testing. The team also installed instrumentation in the field to record actual faults that might occur during the demonstration period. Any actual faults would provide additional verification of the design and operation of this advanced protection system.

The team performed laboratory testing to verify that the ISGD DMS could monitor and control the URCIs. For SCADA data messages, the URCI relays communicate using IEC 61850 MMS protocol, while the ISGD DMS communicates using DNP 3.0 protocol. ISGD DMS receives DNP 3.0 messages via the substation gateway, which translates the messages from IEC 61850 to DNP 3.0. Laboratory testing validated that this translation works effectively and that the ISGD DMS is capable of receiving and responding to the URCI communications appropriately.

4.2.3.3 Commissioning Tests

Commissioning tests consisted of verifying the effectiveness of the radio network communications. The two critical factors that the team evaluated were reliability and latency. The commissioning tests took longer than the team originally expected due to multiple communications challenges with the field radios and substation gateway.

A number of repeater radios were necessary to allow the URCI radios to communicate with each other and with the substation gateway at MacArthur Substation. The first step for commissioning the URCIs was to confirm that the URCI radio repeater locations would be sufficient for the URCI radio communications. When selecting the radio repeater locations, the team had to limit the number of repeaters, since adding repeaters increases the communications latency. Where possible, the team tried to use streetlights for repeater locations since they are higher off the ground. Licenses were required for all repeater locations since they are located on UCI property. The repeater locations also required reliable 120 VAC to power the radios.

There are multiple ways to assess the health of the URCI radio communications. The first and most rudimentary method is to watch the LED lights on the front of the radios. These LEDs indicate whether the unit is powered on, its health status, whether it is able to communicate, whether it is communicating with its neighbors, and whether it has a valid Ethernet cable connection. The mesh LED light remains on if it has a valid communication link. An LED that turns on and off sporadically means that the communications link is unreliable.

Another method for evaluating communications reliability and latency is to use software from the radio vendor that can generate statistics on communications link strength. One of these statistics is RSSI. RSSI measures the power received in a radio signal. The software can also ping the other radios that it is communicating with in order to evaluate latency. Pinging another radio provides an indication of how reliable the link is and how fast the radios can communicate with each other. The ISGD team used these two tools to identify valid radio repeater locations.

The team used the following acceptance criteria for evaluating the URCI radio communications.

- Reliable communications links with RSSI readings greater than -80 dBm and an 80% ping success rate
- URCI to URCI communications latency of less than 100 ms
- Constant 120 VAC power supply availability

The team encountered a number of challenges when performing the URCI radio commissioning tests that required troubleshooting of the radio equipment and the substation gateway. These challenges involved both the communications reliability and latency.

The team completed the URCI radio and radio repeater installations in April 2014, which allowed the team to begin thoroughly testing all the communications links. The team immediately determined that the original installation plans were not sufficient to achieve effective and reliable communication. For example, the MacArthur Substation head-end radio required two sectional antennae to communicate with two adjacent radio repeaters (rather than a single omnidirectional antenna). Each of these antennae required two 40-foot cable and connectors, which negatively impacted the RSSI. **Table 42** lists the various challenges the team encountered while commissioning the URCI system as well as the resolution of these challenges.

Table 42: URCI Commissioning Challenges

Challenge	Resolution
1. Challenges obtaining licenses for repeater radio locations limited the team’s options for repeater radio siting	a. Radios were installed on the UCI campus (private property), eliminating the need for city licenses, but still required licenses from the university
2. Unreliable communication from MacArthur Substation to adjacent repeater radios	a. Increased antenna heights at MacArthur Substation and Repeater 1 b. Improved the antenna alignment
3. Unreliable communications between URCIs and omni-directional antenna due to tree growth	a. Switched from omni-directional antenna to panel antenna, which improved the radio signal transmission strength b. Moved the antenna location to inside a fake vent pipe, which improved the line of sight with the repeater radio
4. Unreliable communications at a number of radio installation sites	a. Changed to antennas with greater gain b. Changed to different radio channels c. Improved the antenna alignment d. Removed physical obstacles (e.g., a temporary construction fence)
5. Different voltages for streetlights and UPS equipment	a. Installed instrument transformers for locations with 240 VAC (since all UPS equipment was rated up to 130 VDC)
6. Streetlights were not always on due to the use of photocells to only turn the lights on after dark	a. Worked with the Irvine Campus Housing Authority (ICHA) to bypass the street light photocell controllers
7. Universal protection settings are not realistic in the field environment	a. Used different protection settings for each URCI based on protection criteria and circuit configuration
8. Substation gateway latency was too long, increasing the chance that, during a fault, the substation circuit breaker would trip when it should not	a. Worked with the substation gateway vendor to reduce the latency to an acceptable level

The team has concluded all initial field testing of the radio network communications. In January 2015, the team will verify that the ISGD DMS is able to monitor and control the URCIs. The team will also perform an “end point test” to test all the functionalities of the URCI protection scheme. Once these two tests are complete, the team will verify that the URCIs perform the correct operations when a fault occurs. While the URCIs are in a bypass condition, the team will use Doble Simulators to inject voltage and current into the relays. This testing will rely on COMTRADE files created from the RTDS simulations, which the team will replay through the Doble Test sets to simulate fault conditions. The team will simulate faults on each section of load between each protection device

and verify that the correct devices operate. The team expects to conclude these final commissioning tests and to begin operating the URCl system in January 2015.

4.2.3.4 Field Experiments

4.2.3.4.1 *Field Experiment 5A: Self-healing Circuit*

This consists of a passive experiment whereby the team will verify self-healing circuit capability on an energized circuit only if a fault occurs on the circuit. Although the team will not induce a fault to test this capability, it has been tested using lab simulations. It will also be tested by isolating the URCl from the circuit using the bypass switches, and then injecting fault currents into the field devices. This testing will not interrupt any customers' service. The team currently expects the URClS to be in service by January 2015. Once they are in service, the team will be able to assess their effectiveness if a fault occurs on the circuit during the demonstration period.

4.2.3.4.2 *Field Experiment 5B: De-looped Circuits*

The team also plans to evaluate the effectiveness of the URCl capability when the two circuits are de-looped. There are a number of scenarios where the two circuits cannot operate in a looped configuration, including when the circuit loading exceeds 600 A, when additional circuits need to be tied to Arnold or Rommel (to deal with a temporary issue), or if box loops occur.

4.2.3.5 Impact Metrics and Benefits Analysis

The Final Technical Report will address the impact metrics and benefits, to allow sufficient time for the project team to accumulate sufficient data and perform the necessary analyses.

4.2.4 Sub-project 6: Deep Grid Situational Awareness

The objective of this sub-project is to demonstrate how high-resolution power monitoring data captured at a transmission-level substation can detect changes in circuit load from a DER such as demand response resources, energy storage, or renewables. Phasor measurement units (PMUs) are used to capture this data. Such a capability could help enable aggregators of such resources to participate in energy markets by providing a means of verifying resource performance. The 2 MW DBESS from sub-project 3 will support this testing. The team will operate the DBESS to produce load changes of various magnitudes and durations, and at various ramp rates, to simulate the behaviors of DERs. The team relocated the DBESS to the field in March 2014, and first connected it to the grid on April 15, 2014. The team completed various commissioning activities between April 15 and September 18, 2014 (see section 4.2.1.2). Testing in support of sub-project 6 commenced on September 19, 2014. This section describes testing activities conducted between September 19 and October 31, 2014. The Final Technical Report will summarize the remaining testing activities.

4.2.4.1 Pre-deployment Testing

Section 4.2.1.2 summarizes the pre-deployment testing that the team performed on the DBESS to support the sub-project 6 testing. In addition, Appendix 7 provides a detailed explanation of how the UCI team designed the adaptive filter and ANN to support the PMU data analysis.

4.2.4.2 Field Experiments

4.2.4.2.1 *Field Experiment 6A: Verification of Distributed Energy Resources*

The lead UCI researchers for this sub-project divided the field experiment into two phases. Phase 1 consists of dispatching the DBESS to follow a variety of different real power charge/discharge profiles, including step, ramp, impulse, and saw tooth functions at magnitudes covering the extent of the system's capabilities (-2 to 2 MW), and

at different on- and off-peak periods throughout the day. The purpose of phase 1 testing is to determine the characteristics of the system (DBESS and grid) and refine the algorithms for PMU data analysis. Phase 2 consists of dispatching the DBESS to follow additional charge/discharge profiles developed based on the phase 1 results. Phase 2 will include the actual PMU data analysis and results of this field experiment.

Phase 1 testing began on September 19, 2014, and consisted of a simple charge/discharge step profile with a +/- 2 MW amplitude. The charge/discharge sequence was as follows:

1. Maintenance charge(s) prior to 8:00 am
2. Discharge at 2 MW at 8:00 am until the battery is discharged and the system output reduces to 0 MW, then go to idle mode
3. Charge at 2 MW at 10:30 am until the battery is fully charged and the system input reduces to less than 500 kW, then perform a maintenance charge(s), then go to idle mode
4. Discharge at 2 MW at 12:00 pm until the battery is discharged and the system output reduces to 0 MW, then go to idle mode
5. Charge at 2 MW at 2:00 pm until the battery is fully charged and the system input reduces to less than 500 kW, then perform a maintenance charge(s), then go to idle mode
6. Discharge at 2 MW at 5:00 pm until the battery is fully discharged and the system output reduces to 0 MW, then go to idle mode
7. Charge at 2 MW at 7:00 pm until the battery is fully charged and the system input reduces to less than 500 kW, then perform a maintenance charge(s), then go to idle mode
8. Discharge at 2 MW at 9:00 pm until the battery is fully discharged and the system output reduces to 0 MW, then go to idle mode
9. Perform maintenance charge(s) after completion of item 8

The DBESS operator was able to perform the 8:00 am, 10:30 am, and 12:00 pm charges and discharges per the sequence above, but had to stop testing due to several related issues, including chiller alert, inverter temperature climb, and rack temperature differential error messages in the control system. The inverter temperature climb also caused the operator to manually reduce the 10:30 am charge power from 2 MW to 1 MW approximately 13 minutes into the charge in order to keep the inverter from overheating and tripping. All of these issues were cooling-related and indicative of a problem with the chiller. The DBESS operator shut down the device and paused testing until the chiller could be serviced.

On September 26, the chiller experienced a mechanical failure before it could be serviced, resulting in a complete cooling system failure for the battery/PCS container. Since the system was already shut down when this happened, it did not pose an immediate safety or integrity concern. However, without cooling, the auxiliary systems in the container (including controls and fan motors) increased the interior temperature of the container to nearly 100 degrees Fahrenheit during the day.

On September 29, the chiller was inspected by an HVAC contractor, who found a faulty cold water flow sensor which prevented the chiller's water circulation pumps from turning on. The contractor ordered a replacement part and then installed it on October 9, restoring the cooling system to full functionality.

On October 24, 2014, the original 2 MW step profile test was successfully repeated in its entirety. The system was capable of following the test sequence, but still exhibited some minor failures. One of the in-row air conditioners had an intermittent temperature and humidity sensor fault, which resulted in that unit running at full air volume capacity. This behavior did not decrease the performance the battery system, and only had the effect of locally decreasing the container's interior temperature a few degrees below normal. Also, one of the container's 18 battery racks reported a "module cell voltage sum error," which indicated a battery module was out-of-balance with the rest of the rack. The team observed this type of error during lab testing and commissioning. It is more prevalent as the system ages and/or operates at maximum power for an entire charge/discharge cycle (which increases cell/module imbalance). Again, this error did not significantly affect the performance of the system.

Figure 69 summarizes the complete charge/discharge profile as recorded by the local PQM at the point of interconnection. The UCI research team used this data in conjunction with PMU data to support system characterization and refinement of algorithms for future PMU data analysis. The Final Technical Report will describe this PMU data analysis.

Figure 69: DBESS Charge/Discharge Profile (October 24, 2014)



The gradual tapering of the maximum charge/discharge amplitude over the course of the day is representative of the system’s normal output degradation due to heat buildup in the batteries and PCS, which affects the capabilities of the system. Also, the current control system is open-loop and uses calibration constants to achieve a particular power output for a given set point. The team will replace the control system in early 2015 to include closed-loop monitoring of the PCS output, which will decrease reliance on calibration constants and more tightly regulate the output. Other charges and discharges (significantly less than 2 MW) relate to auxiliary loads (such as the chiller turning on and off to regulate temperature) and maintenance charges to balance and top off the batteries after a full charge.

4.3 Interoperability & Cybersecurity

4.3.1 Sub-project 7: Secure Energy Net

Smart grid capabilities typically require electronic communications between field devices and utility back office systems. Creating SENet was one of ISGD’s most technically demanding and resource intensive sub-projects. Its development had to address diverse communications and security requirements for back office services, including data collection and control functions for a variety of applications involving field equipment. Although the SENet design was mindful of interoperability and cybersecurity needs, it also had to accommodate legacy SCE systems. Using a rigorous systems engineering approach, SCE designed, developed, integrated, and tested several communication networks and back office software systems. SENet operated as planned since deployment. It

represents a solid baseline for future SCE distribution system back office automation. The Final Technical Report will provide a review of SENet's performance over the project.

4.3.2 Sub-project 7: Substation Automation 3

The goal of SA-3 is to transition substations to standards-based, automated configuration of communications, interfaces, control, and an enhanced protection design. Achieving these goals will provide enhanced system interoperability and enable advanced functionalities such as automatic device configuration while introducing integration compatibility with legacy systems. The Final Technical Report will provide a review of SA-3's performance over the project.

4.4 Workforce of the Future

This project area does not include any field experimentation or performance testing. The results of the organizational assessment will be included in the Final Technical Report.

5. Conclusions

This chapter draws upon the results documented in chapter 4 to summarize the key conclusions and learnings of the ISGD project team. These conclusions include lessons learned, organized around the four ISGD domains, an evaluation of the commercial readiness of the various ISGD capabilities, and specific “calls to action” for the various industry stakeholders.

5.1 Lessons Learned

Over the course of the design, deployment, and demonstration periods, the team has accumulated a series of insights that may be useful to the project stakeholders and to the utility industry more broadly. This section provides a summary of these lessons. This first TPR includes lessons from the first eight months of field experimentation. This second TPR adds to the initial list of lessons learned, while the Final Technical Report will provide additional lessons learned.

5.1.1 Smart Energy Customer Solutions

5.1.1.1 Smart Inverter Standards Are Too Immature to Support Product Development and Market Adoption

The ISGD project originally intended to use smart inverters to support DVVC and the integration of rooftop PV solar panels and energy storage devices. The project has been unable to use smart inverters due to the absence of standards and UL certification of these devices. The IEEE 1547 standard (standard for interconnecting distributed resources with electric power systems) has been modified to include provisions for smart inverters. UL needs to update the relevant testing standard (UL 1741) to meet the revised interconnection standard and certify devices for home and business installations. SCE and other utilities are also modifying interconnection procedures to understand, verify, and possibly control these advanced inverter functions.

5.1.1.2 Proper Integration of Components from Multiple Vendors is Critical to the Successful Operation of Energy Storage Systems

Many energy storage systems use components from multiple manufacturers. The two most significant components, the battery and inverter, are not produced by the same manufacturer. For example, the CES unit used in sub-project 1 uses a lithium ion battery and BMS from one vendor, and a power conversion system from another vendor. When integrating these devices, careful evaluations must be performed to verify that the systems’ control mechanisms are compatible. In the case of the Solar Car Shade BESS, the inverter draws energy from the battery at a level that the BMS cannot detect. Since the BMS does not detect the low level of current drawn by the inverter, it cannot consider this lost energy when determining the BESS’s state of health. More detailed testing by the vendors could have identified and resolved this issue before deployment.

Customers or device end-users typically do not choose a battery or BMS vendor and a PCS vendor, and then perform the integration themselves. Instead, the battery/BMS vendor, PCS vendor, or an independent integrator chooses the components and performs the final integration. Whichever entity performs the integration should conduct a final system evaluation prior to selling the device to customers. The integrator should be responsible for ensuring the various subsystems in their final product are compatible. In the case of the emergent technologies and integration techniques used in energy storage systems, it may also be wise for the customer (if technically capable) to work with the integrator to perform their own customized system acceptance testing on the completed product prior to final acceptance and payment.

5.1.1.3 Improved Battery System Diagnostic Capabilities Are Required to Help Identify the Causes of Failures

In October 2013, the sub-project 2 BESS tripped, causing the battery to shut itself down using protections built into the system. The ISGD team immediately downloaded the diagnostic data collected by the BESS and investigated the issue with the manufacturer. However, the manufacturer was unable to identify the cause of the trip. The system had followed a self-protection scheme designed and implemented by the manufacturer, but it did not record enough diagnostic information for the manufacturer to understand exactly what happened. Although the system returned to normal operation, the manufacturer made no changes that would prevent a similar trip in the future since they could not determine the cause of the trip. In the event of failures or unexpected events, battery systems need to capture detailed information to properly identify the cause of the event. This type of issue is not limited to this device or manufacturer, and is characteristic of emerging technologies and applications where manufacturers' design and integration techniques are still maturing.

5.1.1.4 Manufacturer Implementations of the SAE J1772 EVSE Standard Limit the Usefulness of Electric Vehicle Demand Response

PEVs have the potential to increase customer electricity demand substantially during peak periods. Peak periods include times of high electricity demand on the entire electric system or on particular distribution circuits. To help mitigate the potential impacts of PEV charging activity, ISGD is evaluating DR functions that specifically target PEV load. The eventual development of utility load management programs for PEVs may be helpful in empowering customers to better manage their PEV charging costs while also helping to preserve grid stability.

One of the prerequisites for conducting effective PEV load management is being able to send DR signals that reduce PEV load on a consistent and reliable basis. For example, if a vehicle is currently charging at 7.2 kW, a 50% duty cycle DR event should reduce the charging rate to 3.6 kW. During ISGD's commissioning tests, SCE determined that EVSE manufacturers have implemented the DR function in a way that may limit the effectiveness of PEV load management. Currently, when a DR event signal²⁴ is sent to an EVSE to reduce the charging level by a certain percentage (e.g., 75% of current output), the EVSE reduces the charging level based on the maximum charging capacity of the EVSE, not by the actual PEV charging level. The project EVSE has a maximum capacity of 7.2 kW, so a 75% duty cycle DR event signal would cause the EVSE to reduce its charge level to 5.4 kW (75% of the 7.2 kW maximum charge level).

Meanwhile, PEV charging levels are also constrained by the vehicles themselves. For example, the Chevrolet Volt's maximum charging level is 3.3 kW, while the BMW ActiveE's is 6.6 kW. To illustrate why this matters, suppose both vehicles are charged using an EVSE with a maximum charging capacity of 7.2 kW. A 75% duty cycling DR event signal would reduce the current charging level to 5.4 kW for both vehicles. This would reduce the BMW Active E charge level from 6.6 kW to 5.4 kW, but the Volt would continue to charge at 3.3 kW (since the Volt's maximum charge level is below the 75% duty cycle level of 5.4 kW). The inconsistency and unpredictability of the impact of this type of DR event limits its usefulness as a tool for managing PEV load.

DR signals that reduce PEV charging levels based on the current charging rate would make PEV load management more effective for managing grid conditions in real-time. Using the example above, a 75% duty cycle DR signal would reduce the charging levels of both vehicles to 75% of their current charging levels. To accomplish this objective, the EVSE or PEV should actively monitor the charging load and use the SAE J1772 and the relevant Smart Energy Profile (SEP) communications standards to determine the desired charging rate.

EVSE manufacturers can enable DR on a "percentage of load" basis by incorporating a meter to provide the real-time charging level and a microcontroller to convert DR event signals into a demand setpoint that corresponding to

²⁴ SCE uses SEP duty cycle messaging to perform PEV demand response.

the setpoint defined by the SAE J1772 standard. The EVSE can then use its “pilot wire” to reduce the charging level to the desired rate.²⁵

PEV manufacturers could also leverage their existing vehicle metrology to implement this capability in the same manner. In this case, the meter and microcontroller would be located within the vehicle. Upon receiving a utility DR signal (via a smart meter or an internet connection to the vehicle), the vehicle would read the current vehicle load, use a microcontroller to convert the DR signal into the desired power level, and then modify the vehicle charging to the desired level. The Smart Grid Interoperability Panel (SGIP) and the ANSI Electric Vehicle Standards Panel are two standards organizations that could facilitate PEV and EVSE manufacturer efforts to develop these solutions. The industry would also benefit from a service bulletin from SAE that clarifies the terminology used in the J1772 standard (e.g., the duty cycle of the pulse width modulation versus the PEV charging rate), and explains the limits of the standard for constructing demand response capabilities within EVSEs and PEVs.

5.1.1.5 Distributed Energy Resources Should Be Designed and Tested to Ensure Communications and Operations Compatibility with Utility Control Systems

During a demand response event using a group of RESUs, two RESUs that should not have responded to the DR event signal did so by exporting PV power to the grid. Following a battery error in October 2013, the two RESUs turned off their internal battery chargers and inverters. These RESUs did not charge or discharge for several weeks. However, both of these RESUs received the DR event signal on November 7, 2013. When the event began, the RESUs began outputting PV power to the grid. This was unexpected, since the team believed that the battery error would prevent the inverter from operating. Based on discussions with the manufacturer, the team determined that the manufacturer had incorrectly programmed the RESUs to allow PV operation during the battery error. The manufacturer addressed this programming bug in a subsequent software release that was installed in all the RESUs. This experience highlights an important issue with respect to the potential future development of utility programs for managing DERs. Device manufacturers must design and test their products to ensure that any utility-provided signals do not lead to erroneous device behavior. This is the manufacturer’s responsibility, since certifications (including UL standards, communication protocol specifications, etc.) cannot address the wide range of functionality of the various devices. This is true for energy storage, DERs, smart inverters, smart appliances, electric vehicles, and other equipment that may interact with the electric grid in the future.

5.1.1.6 Remotely Monitoring New Technologies after Field Deployment Is Critical to Timely Identification and Resolution of Unknown Issues

Technology components that have undergone laboratory, commissioning, and other forms of testing may still encounter operational issues following field deployment. This may be due to environmental or other factors. For example, ISGD is demonstrating multiple HAN devices in an integrated environment using multiple communications networks. It is thus important to continue monitoring these devices following deployment to assess their interoperability and potential for interference with each other. Refer to the RESU Battery Error discussion in section 4.1.1.3.3 of the first TPR.

5.1.1.7 Targeted “Behind the Meter” Data Collection Will Help Future Demonstration Analytics

The team implemented an approach for monitoring energy usage in the project homes to measure the potential impacts of the energy efficiency measures and demand response events. This data acquisition system allows the team to monitor up to 21 individual circuits in each home (watts, watt-hours, amps, and voltage), the total household energy usage, and the RESU loads. The system also measures loads plugged into the wall, and temperatures on each floor and within the air conditioning duct system. Over the course of the design, installation,

²⁵ SCE has leveraged this ISGD finding by working with an EVSE manufacturer to implement this capability with EVSEs used for the “Smart Charging Pilot,” a CPUC-funded DR pilot project. This is outside of the ISGD project.

commissioning, and operation of this system, the ISGD team identified a number of lessons for how to improve such a system in future demonstrations. These findings are summarized in Appendix 3.

5.1.1.8 Consistent Implementation of Smart Energy Profile Demand Response Messaging Across Customer Device Types Would Simplify Aggregated Demand Response

During the ISGD team's DR testing of the EVSEs and PCTs, it discovered that these devices interpret duty cycle percentages differently. For example, PCTs typically interpret a 100% duty cycle event as a command to shut down the AC operation completely. Conversely, the EVSEs used on ISGD would interpret the same signal as a request to charge at 100% of their operating capacity. Thus, these two devices would have the opposite reactions to the same duty cycle signal. The PCTs and EVSEs used on ISGD are SEP 1.x compliant. This standard provides discretion to the manufacturer in implementing DR duty cycle communications. This flexibility has led to inconsistent implementation of this standard among the ISGD devices.

For utilities to perform DR events using multiple sources of customer load—such as PCTs and EVSEs—signals should be interpreted consistently across all DR-capable customer devices. Inconsistent interpretations of DR signals would result in some devices responding properly and other devices not responding properly. For example, a 100% duty cycle using the ISGD devices would result in the PCTs shutting down the AC units, but also commanding the EVSEs to charge at their maximum capacity. For utilities to maximize the resources available for demand response within a simultaneous DR event, the utility and device manufacturer community should agree on a common interpretation of duty cycle percentages. This challenge should be addressed by the ZigBee Alliance, the organization responsible for developing the SEP 1.x standards, and IEEE, the organization responsible for the SEP 2.0 standards.

5.1.1.9 Assessing the Impacts of Energy Efficiency Measures Requires Isolating Customer Behavioral Changes

The primary benefit of installing EEMs at a customer premises is improved energy efficiency. This reduces the energy required to perform a specific function, such as lighting a customer home. It also reduces a customer's energy costs. To evaluate the impact of an EEM on a home's energy consumption, it is necessary to isolate the effects of the technology from any changes in customer behavior that may occur over time. For example, the homes in sub-project 1 received rooftop solar PV panels as part of the ISGD project. Some homeowners have acknowledged that they have increased their AC usage because they now have "free energy" available during the day. Therefore, simple comparisons of these homes' energy usage before and after installing the EEMS mask these types of potential behavioral changes. Other changes may include changes in occupancy, vacation or work schedules, and weather-driven changes.

The ISGD team has addressed this challenge by comparing the ZNE simulation results to the actual energy consumed within each home. The simulations estimated how much energy each home would consume after installing the EEMs, under similar conditions (e.g., weather and customer behavior). The difference between the simulation results and the actual ZNE performance should explain some of the changes in customer behavior. Another potential method for evaluating EEMs that isolates the impacts of human behavior involves installing the EEMs in a test home with no occupants. Scheduled on/off cycles for various appliances, lighting, heating and cooling could allow experimenters to compare the energy usage patterns with a comparable test home without the EEMs.

This lesson also reveals the impact of cost on how customers use electricity. Installing free solar PV on customer homes created an incentive for these customers to increase their energy use. This finding reinforces the notion that customers respond to price incentives.

5.1.1.10 When Deploying Systems with Components from Multiple Vendors, a Careful Commissioning Plan Should Be Constructed

Several months after completing the rooftop solar PV installations on the sub-project 1 homes, the ISGD team performed an analysis of the solar PV output on the ZNE and RESU block homes. The purpose of this analysis was to assess the homes' solar PV output over time and across all the project homes. This analysis revealed that three homes (out of the 14 homes on the ZNE and RESU blocks) were generating substantially less solar PV than their peers. During a subsequent on-site visit to two of these homes, the team identified and resolved issues from the original solar PV installations. The solar PV output of both of these homes immediately improved after fixing these two installations. The problem with the third home resulted from shading.

The problems with these solar PV installations revealed several important issues. Because the solar PV was from one manufacturer and the RESU units, which contained the solar PV inverters, were from another manufacturer, it was unclear which company was responsible for the performance of the solar PV system. When the ISGD team found issues with the solar PV performance on a home, it had to identify the source of the problem and then work with the vendor to fix the problem. Commissioning the PV in this multi-vendor environment fell to the project team. With this knowledge, the team would design a more rigorous commissioning process for similar future projects to help ensure greater performance of the overall system.

5.1.1.11 Energy Storage Degradation Should Be Factored into Device Control Algorithms and Relevant Utility Load Management Tools

Since the ISGD project commissioned the RESUs more than a year ago, the amount of energy these devices can store has decreased. The team first noticed a side effect of this decline during a demand response experiment on September 15, 2014, in which the RESUs discharged over a five-hour period during the afternoon peak period. As the RESUs neared the end of the DR event, their rates of discharge declined more quickly than the team expected. These discharge rates were lower than what the team observed during the initial lab testing prior to ISGD deployment, and resulted from the RESUs having less energy available than expected during the initial power calculation at the beginning of the DR event (i.e., when the RESU calculates the average rate of discharge over the course of the event). In order to continue discharging throughout the duration of the DR event, as the event progressed the RESUs' internal control systems began reducing power to extend the discharge period of the remaining available energy. This behavior was due to the RESUs' batteries having a lower capacity than during their initial lab tests.

Energy storage manufacturers should ensure that their batteries' control algorithms properly understand that battery degradation will occur and adjust their operation accordingly. The ISGD RESUs have some limited information about battery state of health, including the current battery capacity, which they use to control their discharge rates. Utilities should also be aware that performance does not remain constant over the life of battery products, and they should factor this battery degradation into their load management tools. Failure to account for the actual capacity available in an energy storage device may result in ineffective load management planning and execution.

5.1.1.12 Demand Response Devices Should Be Capable of Decreasing and Increasing Energy Demand

Utilities have traditionally used demand response resources to reduce energy demand during periods of peak energy use, such as hot summer afternoons when AC use is highest. This helps to lower the critical generation peaks, which normally occur only a few days per year. However, DR resources may be useful in helping grid operators manage other types of challenges and opportunities. For example, DR could provide relief to local distribution circuit peaks—such as when demand climbs above the capacity of a distribution transformer. DR resources could also absorb surplus solar PV through pre-heating, pre-cooling, or by charging electric vehicles or stationary energy storage devices. To provide these types of services to grid operators, DR resources need to

become more flexible. They should be able to both reduce energy demand (their traditional function) and increase energy demand.

The ISGD team attempted to perform a pre-cooling DR event with the PCTs in the project homes. The purpose of this experiment was to evaluate the viability of using the project PCTs as a load source. If the team could use DR event signals to turn on AC units to pre-cool a group of homes in the morning and midday periods, then it could potentially reduce the AC energy use in the afternoon peak-period. This capability could potentially be useful for load shifting and other applications such as absorbing surplus solar generation, which could help avoid curtailing renewable generation.

Unfortunately, the project PCTs do not allow pre-cooling. These PCTs ignore commands to reduce their temperature set point below their current set point. The PCTs treat all DR events as “load shedding” events and, therefore, do not respond to DR signals that increases their energy use.

The failure of the PCTs to allow pre-cooling demonstrated the need for vendors to build flexibility into their DR-capable devices. With changing loads in California resulting from the proliferation of renewable energy resources like rooftop solar, there may be times when the electrical grid can benefit from surplus renewable energy. Designing DR-capable equipment with the flexibility to either increase or reduce electricity use depending on the needs of the grid will best serve the future needs of the electric grid.

5.1.1.13 Energy Storage that Supports Islanding Should be Sized Appropriately and Should Only Island During Actual Grid Outages

One source of potential value for energy storage is to use it to provide energy to customers during grid outages. However, it is important that the energy storage device be sized to support the expected maximum customer load. For example, the CES can support loads as high as 100 kVA while grid connected, but will trip under the following conditions when operating in islanded mode: (1) when the load exceeds 62.5 kVA, (2) when the load is between 25 kVA and 62.5 kVA for longer than three seconds, and (3) when the CES battery becomes fully discharged. The daily peak load of the CES Block is usually less than 25 kW, but it exceeds 25 kW at least twice per month. If the CES islands and one of these trip conditions is met, then the CES will trip. If an energy storage device has power capacity that is less than the typical demand that it is expected to serve during an islanding event, then it would likely trip right away following a grid outage.

Another consideration when deploying energy storage to support islanding is to make sure the energy storage device only islands during actual grid outages. If the device identifies grid outages incorrectly and islands itself, this increases the risk of service interruptions to customers. Since energy storage devices trip under certain conditions while islanded—such as when demand is too high—it is possible that energy storage could cause a customer outage even when a grid outage has not occurred. Thus, it is important that the energy storage device’s islanding settings are set correctly such that it only causes the device to island during actual grid outages.

5.1.1.14 Back Up Power for Data Acquisition Systems Should Be Provided When Data Collection is Needed during Power Outages

During a grid outage event on July 8, 2014, the RESUs provided secure load back up using both the stored energy and the solar PV output. However, during this event the ISGD project's data acquisition system components and 4G radios turned off since they were not connected to the RESU secure load circuits. As a result, the team's only data source during the event was the RESU internal data logs. If data collection is necessary during grid outages, then backup power should be provided for the relevant data acquisition systems.

5.1.2 Next-Generation Distribution System

5.1.2.1 Low-latency Radios Are in an Early Stage of Commercial Development

During the design and engineering phase of the project, only one radio vendor partially satisfied the project's requirements for sub-project 5 (the self-healing distribution circuit). This limited the team's procurement flexibility. The team would like to see the vendor community develop radios with latency low enough to satisfy SCE's protection requirements, operate at a radio frequency with sufficient propagation characteristics to obtain adequate coverage (e.g., 900 MHz), and which communicate using the IEC 61850 standard. For the ISGD project, SCE is using 2.4 MHz radios that satisfy SCE's latency requirements, but do not have sufficient coverage. As a result, the project team is using multiple radio repeaters to obtain the coverage needed to satisfy the project requirements. This was particularly challenging due to the terrain, distance, and permitting requirements. The radios are located in an area with a high concentration of hills, buildings, and trees. The team had to install more radio repeaters than originally planned.

5.1.2.2 Permitting Is a Significant Challenge for Siting Smart Grid Field Equipment Outside of Utility Rights-of-Way

The most substantial challenge faced by the sub-project 5 team involved obtaining the necessary permits for siting and installing field equipment (e.g., the pad-mounted cabinets for the URCLs and bypass switches, and the radio repeaters). The URCL field installation was delayed by several months as the team navigated the permitting process with the City of Irvine. The team originally planned to affix all the repeater radios installed on SCE light poles. After finalizing the repeater radio network design, the team met with the City of Irvine, which denied the installation of all the radios on the SCE light poles. The final design consisted of installing radios only on Irvine Campus Housing Authority and UCI property, since the project team was able to obtain permission to perform these installations. This required a larger number of radio repeaters than the original design, since the optimal locations on City of Irvine property were not available.

Permitting represents a potential challenge to the broad scale deployment of smart grid technologies. As municipalities increase their permitting requirements for siting field components, utilities will have less flexibility and fewer options for deploying smart grid capabilities that require field equipment.

5.1.2.3 Radio Communications-assisted Distribution Circuit Protection Schemes are Difficult to Implement

Advanced communications-assisted distribution protection schemes require reliable communications links between distribution protection elements to shield equipment from damage. Several years ago, SCE demonstrated advanced communications-assisted protection using fiber optic links to the field elements, but found it to be costly and difficult to implement. As part of the ISGD project, the team is demonstrating wireless communications for this purpose. Wireless has many potential benefits over fiber in terms of cost and installation time, but it also has challenges. During the process of installing and commissioning the wireless links for the URCLs, the team encountered several challenges. These included finding locations for radios and repeaters, obtaining permission for radio repeater installation (antenna aesthetics are important), unreliable communications links due to

interference and obstructions and design of the network's topology so sufficiently low message latency can be assured. Unless the team can overcome these challenges, the more expensive fiber optic communications might be the only way to put these advanced distribution protection schemes into operation.

5.1.2.4 Distribution Volt/VAR Control Applications Should Be Aware of System Configuration Changes to maximize CVR benefits

During this reporting period, there were instances of circuits being switched from the DVVC controlled bus to the other operating bus in the substation for load balancing. Because the voltage readings continued to be as expected with DVVC on and off, it was some time before the project team discovered this configuration issue. The lesson learned is to design the DVVC system to automatically track configuration of the substation and its circuits.

5.1.2.5 Distribution Volt/VAR Control Capabilities Can Achieve Greater Benefits When Combined with Management of Transmission Substation Voltage Schedules

The team discovered that some transmission substation voltage schedules and transformer tap settings created voltages at the high end of the C84.1 range. Changing these transformer settings allowed the DVVC to achieve better results. Utilities need to consider transmission substation voltage schedules even after installing a system such as DVVC.

5.1.3 Interoperability & Cybersecurity

5.1.3.1 Continued Development of the IEC 61850 Standard and Vendor Implementations of This Standard Are Required to Achieve a Mature State of Interoperability

SCE has implemented an IEC 61850 standard based substation automation system at MacArthur Substation. During this implementation, SCE had to develop temporary workarounds to overcome vendors' design decisions. For example, configuring a substation IED requires both a CID file to configure IEC 61850-related settings and a proprietary file to configure all other settings. Each file typically requires a separate configuration tool provided by the manufacturer. This makes the configuration process cumbersome, especially when a substation uses IEDs from multiple manufacturers. The IEC 61850 standard allows manufacturer-specific data to be included in the CID file. However, manufacturers are using these vendor-specific fields on a limited basis, instead including this information within a proprietary configuration file.

To overcome the challenge of using multiple configuration files, SCE embedded the proprietary configuration files into the manufacturer's CID file. This allows the IED configuration to be managed using a single CID file. A long-term solution is to require that manufacturers adopt the CID file as their configuration format for all settings, and for the standard to further define the structure of the CID file to eliminate incompatibilities between device CIDs. Incompatibilities can result from different interpretations of the IEC 61850 standard.

Another challenge SCE encountered with the IEC 61850 implementation involved configuring the IEDs for sending GOOSE messages. Since GOOSE messages are sent between IEDs, each IED pair/GOOSE message combination must be configured. This configuration process requires that the IEDs' CID files be imported into the manufacturers' IEC 61850 configuration tools. This process must be performed for each GOOSE message, resulting in several iterations of importing and exporting CID files between manufacturers' configuration tools. This process becomes nearly impossible to perform when there are incompatibilities between the manufacturers' CID files.

The IEC 61850 standard also includes many optional features covering many types of IEDs. In practice, these optional fields limit the interoperability between devices from different manufacturers. Since each manufacturer chooses which optional fields to implement, manufacturers may implement different optional fields, restricting interoperability to a very basic level. Greater consistency in the implementation of optional features between manufacturers would improve interoperability.

SCE intends to share its learnings with the Utility Communications Architecture (UCA) International Users Group to help influence the future standard updates.

5.1.3.2 Achieving Interoperability Requires Concentrated Market-Based Development and Enforcement of Industry Standards

Interoperability among devices and systems from different manufacturers requires industry standards. The development of standards requires the guidance and enforcement of either a centralized governance body or the market. It appears that the market is currently driving the industry's slow move toward interoperability.

Although various interoperability standards are emerging, the overwhelming majority of vendor offerings use proprietary network infrastructure that must be integrated one at a time. Although vendor implementations may claim CIM conformance or compliance, their API deployments vary enough that simple integration is not currently possible. Profiles against the CIM (such as the ESPI/Green Button standard) are required to ensure multi-vendor interoperability. The emergence of these standards will depend on the market coalescing around certain products and solutions.

One of the lessons from the ISGD team's experience with SA-3 is that utilities could provide more leadership in bringing third parties (other utilities and the vendor community) together to develop and enforce interoperability standards. The following recommendations to other electric utilities, if acted upon, would help promote the development of interoperable products:

- Demand that vendors design interoperability within their devices by adhering to the IEC 61850 standard; utilities could enforce this by only purchasing devices that are interoperable
- Use relevant electric utility industry forums to promote the idea that standards be implemented in a manner consistent with their intent, which is that products should be vendor agnostic
- Encourage or require vendors to provide a single configuration tool which produces a single IEC 61850-compliant configuration file
- Encourage IED vendors to support the IEC 61850 standard by developing logical nodes that are compliant, thereby reducing the level of propriety configuration workarounds
- Obtain electric utility representation on recognized organizations such as IEEE and the IEC Technical Committee Working Group (IEC TC WG 10 and WG 14)

In the interim, utilities should establish procedures for verifying and validating equipment interoperability prior to deployments. The ISGS team used SCE's substation automation lab to build the entire SA-3 system remotely and commission the functionality of the system prior to deployment. Although this process may not be efficient for every deployment, it allowed the team to thoroughly evaluate and debug the SA-3 system prior to deployment to MacArthur Substation.

5.1.3.3 An Enterprise Service Bus Can Simplify the Development and Operation of Visualization Capabilities

ISGD coupled SSI with the STI visualization capability to design a situational awareness capability that presents major ISGD elements on a geospatial map in near-real time and on a historical basis. This capability provides grid operators with a greater understanding of the state of the distribution network, distribution circuits, and behind-the-meter devices and applications. This enhanced situational awareness has the potential to diagnose and correct grid events with greater accuracy and speed than what is available today. Key functions of the visualization system include the ability to replay historical events to perform root-cause analysis, drill down to obtain device-level information, and aggregate data into summary information at the circuit or substation levels. This system also eases integration by allowing data to reside within the "system of record," and then being able to retrieve it for presentation when requested by a user.

It is important to use an iterative approach to solicit feedback from end-users when developing and integrating visualization tools. SCE used SSI and STI to develop its visualization capabilities in six to eight week sprints. Initial attempts to gather requirements and deliver the visualization screens provided the end-user with unsatisfactory results. The subsequent adoption of an iterative approach provided a path for end-user buy in.

5.1.3.4 Utilities Need to Perform a System Integrator Role to Realize Smart Grid Objectives

One of ISGD's key interoperability goals is to implement service definitions (i.e., APIs) in an ESB to ensure that CIM compliant interfaces are explicit, testable, and broadly available to the industry. Standardization of the service definitions, together with standardization of the data (i.e., Common Information Model), would create an interoperable grid control environment for smart grid applications.

SCE had some significant success incorporating GE's SSI, an ESB, into ISGD's SENet architecture. Specifically, SSI helped SCE break down system and operational barriers so that a grid control operator can see information from substations, distribution circuits, energy storage devices, and even beyond the meter applications such as smart appliances, solar panels, and plug in electric vehicles. This yields a level of situational awareness not available historically. This could become valuable to grid operators as larger amounts of DERs interconnect with the distribution system.

The ESB is a concept that requires careful consideration when choosing smart grid implementation partners. For utilities to realize their smart grid objectives while maintaining an open architecture using standards, utilities must become the systems integrator (or be able to take on at least some of the systems integrator role). The utility as the systems integrator requires certain key elements:

- Developing a core competency of programming APIs, where necessary (this is crucial since relying on third-party vendors can become cost prohibitive as requirements change or are updated as the architecture matures)
- Understanding the standards at a detailed level with the ability to identify conflicts and gaps early can avoid development pitfalls
- Dedication to working within a CIM framework across the utility can be a long adoption process among internal utility stakeholders
- Demand that vendors use standard service definitions when they have flexibility in their design (although this is difficult to enforce when managing multiple vendors)
- Understanding the utility architecture at a low enough level to anticipate and budget for the level of integration is necessary to manage costs and expectations

5.1.3.5 Effective Communication with Software Vendors Is Critical for Smart Grid Deployments

Software vendors often lack a detailed understanding of the electric utility business. Likewise, utilities often do not understand the software development business. Problems often arise when utilities attempt to communicate their requirements to software vendors. Utilities and software vendors (or other industries) can understand or interpret identical words differently. This results in a false sense of mutual understanding, creating flawed expectations, and incomplete or misunderstood assumptions.

Utilities can accelerate or improve their smart grid deployment efforts by becoming more effective communicating with software vendors. Specifically, utilities should capture and articulate all assumptions made during the design and architecture phases of the software development lifecycle. Since different industries often assign different meanings to identical words, it is important to reach a common and complete understanding of how software should function. This understanding should also include the required capabilities, and interoperability and cyber security features.

Since the electric utility industry is challenging to understand and design software for, larger utilities should prepare themselves to become the systems integrator. This requires a commitment to develop the necessary project management and software development lifecycle skills. These skills would need to be paired with a detailed understanding of the electric grid in order to deploy sophisticated, integrated smart grid capabilities. Smaller utilities may find this integrator role burdensome, and could benefit from waiting until the market for complex smart grid systems and integration services is more mature. This would allow them to adopt smart grid software at a lower cost and with less implementation complexity and risk.

5.1.3.6 Acceptance Testing Should Include Integrated Testing of Software Products and Field Devices in a Lab Environment

One of the standard practices used by utility software developers is to validate system functionality with hardware simulators. This practice is extremely common for many reasons, including the fact that hardware is expensive, bulky, and varies significantly across utilities. Unfortunately, simulators do not realistically represent actual hardware, which often leads to erroneous factory acceptance testing. Simulation testing places the burden on the utility to validate software performance using real hardware during site acceptance testing.

Vendors that develop distribution substation software that controls field equipment should conduct simulations using these field devices. These simulations should be part of the development and factory acceptance testing procedures.

Equipment vendors should also conduct lab testing with actual fixed devices (e.g., relays, programmable logic controllers, and gateways). This testing should include voltage and current injection testing equipment. Real-time digital simulator controlled injection testing, although expensive, would also improve the simulation quality.

Utilities should use a real-time digital simulator to build a model of the distribution grid to conduct “closed loop” testing as part of a more thorough acceptance testing process. This simulator should connect to the actual devices in order to perform test scripts prior to field deployment. SCE uses the RTDS product for this purpose and it is a powerful tool for system acceptance testing.

5.1.4 Workforce of the Future

5.1.4.1 Impacts to Department Boundaries and Worker Roles and Responsibilities that Result from Smart Grid Deployments Need To Be Identified and Resolved

Deploying smart grid capabilities has the potential to create new roles and responsibilities for utility workers, especially related to high-speed, secure communications, and advanced field applications and devices. For example, field devices that are monitored and controlled using high-speed communications would require that field personnel have additional IT and communications skills (that they do not currently possess) Sometimes these new requirements impact multiple departments, so it is important to resolve inter-departmental boundary issues early. Some of these new requirements may be difficult to identify, and may not be apparent until installation. These changes may be met with resistance, and they may result in skill gaps. Utilities should address these changing requirements and any potential skill gaps during the design phase, prior to commissioning.

5.1.4.2 Build Training Development Time into Smart Grid Deployment Planning

The most significant challenge the team encountered while developing training materials for the smart grid technologies deployed on ISGD is that the materials were developed in parallel with the design and deployment of the technologies themselves. This was particularly difficult for software components with graphical user interfaces. Training best practices helped the team overcome this challenge. Such best practices include:

- Engaging the workers and their supervisors early on in the process

- Building awareness among the stakeholders
- Involving the stakeholders in the technology development/deployments
- Conducting training sessions that allow participants to touch and feel the technologies
- Providing easy access to training materials for workers

It is highly recommended that time buffers for training development activities be built into project plans between technology stabilization and deployment to ensure that content development is based on as complete a product as possible.

5.2 Commercial Readiness of ISGD Technologies

The Final Technical Report will include a discussion of the commercial readiness of the various technologies demonstrated on the ISGD project.

5.3 Calls to Action

The Final Technical Report will include a list of specific recommendations to various electric utility stakeholders. These recommendations will address the gaps and opportunities identified in 5.1 (Lessons Learned), and will be directed toward the following industry stakeholders:

- Policy makers (federal and state)
- Regulators (e.g., DOE and CPUC)
- Standards Developing Organizations (SDO)
- Industry research organizations (e.g., EPRI and universities)
- Equipment/product vendors
- Service providers
- Utility executives

Appendices

Appendix 1: Abbreviations

AC	Air Conditioner or Alternating Current
ACM	Appliance Control Module
ALCS	Advanced Load Control System
AMI	Advanced Metering Infrastructure
ANN	Artificial Neural Network
ANSI	American National Standards Institute
API	Application Programming Interface
ATP	Acceptance Test Procedures
BESS	Battery Energy Storage System
BMS	Battery Management System
BTC	Broadband TelCom Power, Inc.
Btu	British thermal unit
CAD	Computer Aided Drafting
CCS	Common Cybersecurity Services
CES	Community Energy Storage
CIM	Common Information Model
CLT	Contingency Load Transfer
CMS	Central Management Services
CPUC	California Public Utilities Commission
CT	Current Transformer
CVR	Conservation Voltage Reduction
DBESS	Distribution-level Battery Energy Storage System
DC	Direct Current
DCAP	Distribution Capacitor Automation Project
DEM	Distributed Energy Manager
DER	Distributed Energy Resource
DHCP	Dynamic Host Configuration Protocol
DHW	Domestic Hot Water
DMS	Distribution Management System
DMZ	Demilitarized Zone
DNP3	Distributed Network Protocol
DOE	Department of Energy
DR	Demand Response
DVVC	Distribution Volt/VAR Control
eDNA	Enterprise Distributed Network Architecture
EEM	Energy Efficiency Measure
EMS	Energy Management System
EPRI	Electric Power Research Institute
ESB	Enterprise Service Bus
ESP	Encapsulating Secure Payload
EVCS	Electric Vehicle Charging Station
EVSE	Electric Vehicle Supply Equipment
EVTC	Electric Vehicle Technical Center
FAN	Field Area Network
FAU	Forced Air Unit

FDIR	Fault Detection, Isolation and Restoration
FLISR	Fault Location, Isolation, and Service Restoration
GBS	Grid Battery System
GE	General Electric
GHz	Gigahertz
HAN	Home Area Network
HMI	Human-Machine Interface
HVAC	Heating, Ventilation and Air Conditioning
ICHA	Irvine Campus Housing Authority
IDSM	Integrated Demand Side Management
IEC	International Electrotechnical Commission
IED	Intelligent Electronic Device
IEEE	Institute of Electrical and Electronics Engineers
IETF RFC	Internet Engineering Task Force Request for Comment
IHD	In-home Display
IKE	Internet Key Exchange
IPSec	Internet Protocol Security
ISGD	Irvine Smart Grid Demonstration
IVVC	Integrated Volt/VAR Control
kBtu	Thousand British thermal units
kVA	Kilovolt-amps
kW	Kilowatt
kWh	Kilowatt-hour
LAN	Local Area Network
LED	Light Emitting Diode
LL	Low-latency
LMS	Least Mean Square
LTC	Load Tap Changer
LTE	Long Term Evolution
MBRP	Metric and Benefits Reporting Plan
MHz	Megahertz
MPLS	Multiprotocol Label Switching
ms	Millisecond
MVAR	Megavolt-ampere Reactive
MW	Megawatt
MWh	Megawatt-hours
NEM	Net Energy Metering
NERC CIP	North American Electric Reliability Corporation Critical Infrastructure Protection
NETL	National Energy Technology Laboratory
NIST	National Institute of Standards and Technology
NMS	Network Management System
PCC	Programmable Capacitor Controller
PCT	Programmable Communicating Thermostat
PDC	Phasor Data Concentrator
PEV	Plug-in Electric Vehicle
PLC	Programmable Logic Controller
PLM	Plug Load Monitor
PLS	Permanent Load Shifting
PQM	Power Quality Monitoring
PSLF	Positive Sequence Load Flow

PV	Photovoltaic
QA/UAT	Quality Assurance/User Acceptance Test
RDP	Remote Desktop Protocol
RESU	Residential Energy Storage Unit
RF	Radio Frequency
RLS	Recursive Least Square
RSSI	Received Signal Strength Indicator
RTDS	Real Time Digital Simulator
SAE	Society of Automotive Engineers
SAN	Storage Area Network
SA-3	Substation Automation 3
SCE	Southern California Edison
SCEP	Simple Certificate Enrollment Protocol
SDO	Standards Developing Organization
SEL	Schweitzer Engineering Laboratories
SEMT	Substation Engineering Modeling Tool
SENet	Secure Energy Network
SEP	Smart Energy Profile
SME	Subject Matter Expert
SNMP	Simple Network Management Protocol
SOAP	Simple Object Access Protocol
SOC	State of Charge
SOH	State of Health
SQL	Structured Query Language
SSI	Smart Grid Software Services Infrastructure
STI	Space-Time Insight
TLS	Transport Layer Security
TPR	Technology Performance Report
T&D	Transmission and Distribution
UCA	Utility Communications Architecture
UCI	University of California, Irvine
UL	Underwriters Laboratories
URCI	Universal Remote Circuit Interrupter
VAR	Volt-ampere Reactive
VRT	Voltage Rise Table
WAN	Wide Area Network
XML	Extensible Markup Language
ZNE	Zero Net Energy
ZNEE	Zero Net Electric Energy

Appendix 2: Build Metrics

Over the course of the project, the ISGD team files “build metrics” with NETL on a quarterly basis. The tables in this appendix summarize the ISGD build metrics as of September 30, 2014. Interested parties can obtain future updates to these metrics on the smartgrid.gov website:

https://www.smartgrid.gov/project/southern_california_edison_company_irvine_smart_grid_demonstration/latest_data

AMI smart meters installed and operational	Quantity	Cost
Total	38	\$59,559
Residential	38	
Commercial	0	
Industrial	0	
AMI smart meter features operational	Feature enabled	# of meters with feature
Interval reads	Yes	38
Remote connection/disconnection	Yes	38
Outage detection/reporting	Yes	38
Tamper detection	Yes	38
AMI communication networks and data systems	Description	Cost
Backhaul communications	The backhaul from the collector meters (cell relays) to SCE back office uses 4G cellular services employing the CDMA protocol	\$0
Meter communications network	Meter to meter and meter to collector (cell relays) use 900 MHz communications in the ISM band and uses Itron’s RF Mesh protocol	
Head end server	The head end system consists of Itron’s OpenWay system. The primary component is the Network Management System (NMS). The function of the NMS is to pass through meter data (e.g., consumption), events, and two-way communications between the meters and MDMS. Other tasks performed by the NMS include managing meter configurations, managing groups of meters, and supporting reads of individual meters for diagnostics.	\$1,075,244
Meter data analysis system	All meter data are collected through the Network Management System and stored in an Oracle relational database	
Other IT systems and applications	Not applicable	
Web portal deployed and operational	Quantity	Description
Customers with access to web portal	0	The gateway that each home has received is capable of displaying a web portal
Customers enrolled in web portal	0	

Customer systems installed and operational	Quantity	Description	Cost
Communication networks and home area networks	N/A	A HAN is a network established in the home to enable access, control, and operation of devices such as appliances and air conditioners. ISGD uses the Zigbee Smart Energy Profile 1.X protocol for the HAN network.	N/A
In home displays	22	Most IHDs provide consumers with comprehensive information about their energy consumption, including: current household energy use in both kilowatts and dollars per hour, daily energy cost, including a comparison to the prior day's cost, the real time cost of electricity, monthly bill tracking with up-to-date billing information and an estimated end – of-month bill, and demand response event messages.	\$7,020
Energy management devices	22	Energy management systems control loads in the home and centralize operation and control of other HAN devices. They typically function as a gateway or hub and can be accessed locally in the HAN or remotely through the meter of the internet.	N/A
Direct load control devices	0	Not applicable	\$0
Programmable communicating thermostats	31	PCTs are capable of communicating wirelessly with the HAN and enable customers to take advantage of AC DR pricing programs.	\$9,610
Smart appliances	64	Smart appliances are capable of receiving signals from the AMI HAN and can react to DR commands from an AMI load control system. The smart appliances being evaluated on ISGD include refrigerators, dishwashers and clothes washers.	\$137,428
Customer system communication networks		Description	
Network characteristics within the customer premises		A HAN is a network established in the home to enable access, control and operation devices such as appliances and air conditioners. ISGD uses the Zigbee Smart Energy Profile 1.X protocol for the HAN network.	

Distributed energy resources	Quantity	Capacity	Description	Cost
Distributed generation	23	108 kW		\$390,288
Energy storage	16	181 kW		\$1,850,130
Plug-in electric vehicle charging points	44	158 kW		\$234,022
Distributed energy resource interface	Not applicable	Not applicable	RESUs connect via internet connection to a server accessible on the network. A utility interface is hosted on this server showing detailed information regarding both current status and history of each of RESUs activity. This interface is a web page accessible in a standard browser. Some of the information viewable includes: the power being dispatched or drawn from or to the grid, the PV power passing through each unit, the energy available in each RESU, the reactive power of each unit and a log of errors and events on each system. This interface allows the utility to group the RESUs and control them in bulk. From this interface, the utility can send Demand Response events specifically to a group of RESUs, set up a specific charging or discharging schedule, enter any of the Smart Modes built in to the devices, and enable or disable Reactive Power Support. The Community Energy Storage (CES) is controllable and accessible through a SCADA interface utilizing DNP3 communication. A Distributed Energy Management (DEM) server communicates with the CES via this SCADA connection to log data and allow remote control of the system. The DEM displays voltages, power (real and reactive), battery energy, and monitors CES system alarms. ISGD CES operators use the DEM to send operating commands, including setting up a daily charge and discharge schedule. The DEM also allows control over the islanding behavior of the CES; this can be inhibited or manually triggered as desired.	\$0
Electric distribution system			%	Description
Portion of distribution system with SCADA due to SGIG/SGD program			0%	Not applicable to project
Portion of distribution system with SCADA due to SGIG/SGD program			0%	Not applicable to project
DA devices installed and operational		Quantity	Description	Cost
Automated feeder switches		0	Not applicable to project	\$0
Automated capacitors		0		\$0

Automated regulators	0		\$0
Feeder monitors	0		\$0
Remote fault indicators	0		\$0
Transformer monitors (line)	0		\$782,755
Smart relays	0		\$0
Fault current limiter	0		\$0
Other devices	0		\$0
SCADA and DA communications network			Cost
Communications equipment and SCADA			\$0
Distribution management systems integration		Integrated	Description
AMI		No	DMS is used by system operators to monitor and control the distribution system. DMS will also be used to monitor and display to the system operator the status of the URCLs and provide manual override capabilities. DMS is also being used to control distribution capacitors and provide capacitor readings to DVVC.
Outage management system		No	Not applicable to project
Distributed energy resource interface		No	
Other		No	Not applicable to project
Distribution automation features/functionality		Function enabled	Description
Fault location, isolation and service restoration (FLISR)		No	Not applicable to project
Voltage optimization		No	Anticipated for ISGD: DMS will be used to control distribution capacitors and to provide voltage readings to DVVC.
Feeder peak load management		No	Not applicable to project
Microgrids		No	Not applicable to project
Other functions		No	Not applicable to project

Appendix 3: Instrumentation for Home Data Collection

A3.1 Requirements

During the ISGD design phase, the team needed to identify a method for monitoring the electricity usage in the project homes. This includes 38 homes (16 control homes and 22 homes with modifications). These homes are located on four blocks in the University Hills housing area of UCI. This monitoring system has to help the team measure the electricity savings stemming from energy efficiency upgrades. It also has to measure the impacts of the ISGD field experiments. The data acquisition system needs to monitor up to 21 individual circuits in each home (watts, amps, voltage, and watt-hours) as well as loads plugged into the wall (watts, watt-hours), ambient temperatures on each floor, and temperature in the air conditioning duct system. Data should also be recorded at down to one-minute intervals. The monitoring system also needs a method to communicate data back to SCE's back office where it is stored, validated, and made available to users. After researching several systems, the team selected a package assembled by TrendPoint for implementation in the homes. In addition to this system, the team installed two additional Smart Connect® meters in each home to avoid disturbing the existing billing meter.

A3.2 Design Overview

The TrendPoint monitoring system is composed of a data collection and communications cabinet installed in the garage as well as sensors located throughout each home. In addition to the monitoring equipment, a HAN supports communications between the project's Smart Connect meter and the smart appliances, thermostat, in-home display, EVSE, and RESU.

A3.3 Data Collection Cabinet

The TrendPoint data collection cabinet houses a number of monitoring and communications components, which are depicted in **Figure 70**. These components include:

- TrendPoint Enersure circuit monitoring board (with its potential transformer)
- Schneider ION meter(s) and Babel Buster (converts metered readings to Simple Network Management Protocol (SNMP)/Ethernet)
- Packet Power wireless gateway (receive signals from wireless plug load monitors and temperature sensors)
- GE 4G radio with externally mounted antennae
- Current transformer shorting blocks, Ethernet switch, and power supplies

Figure 70: Home Data Collection Cabinet Arrangement

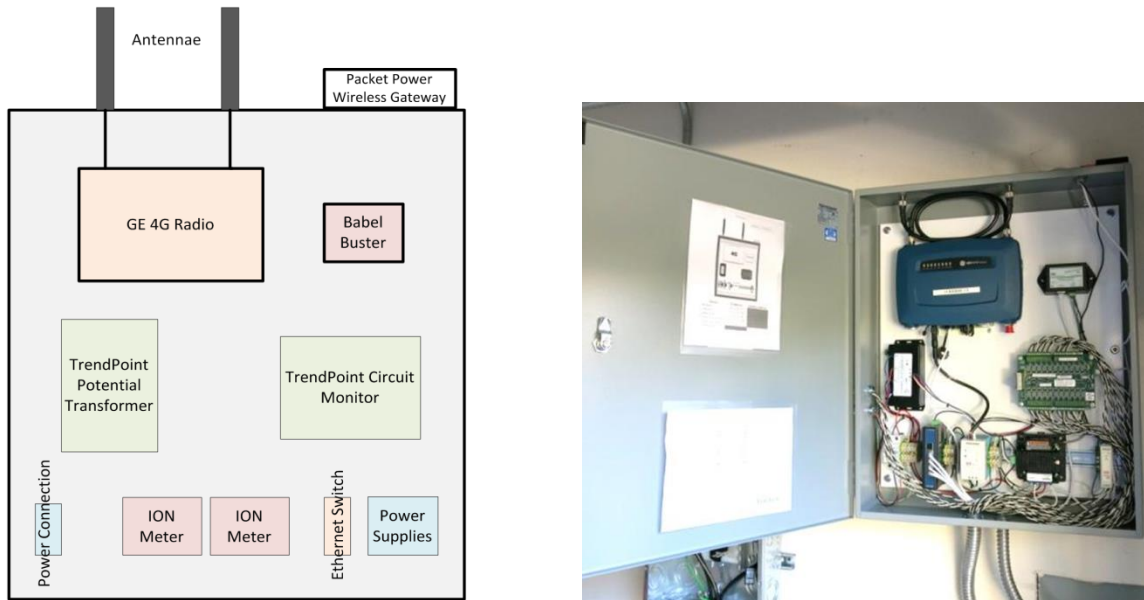

Due to the limited modifications in the control homes, these homes only received a data collection cabinet with a wireless gateway, 4G radio, and required power supplies. **Figure 71** depicts how these components are connected. All data collected in the cabinet is converted to Ethernet, which is pooled in an Ethernet switch and connected to the 4G radio for transmission to the TrendPoint server located in the SCE back office in Alhambra. This path uses the public cell system to the public carrier back office where the data is placed on a leased circuit going directly to SCE’s Alhambra facility. All data is converted to SNMP for transmission to the back office. The project also uses this 4G link to communicate directly with the RESU.

Figure 71: Home Data Collection Cabinet Block Diagram

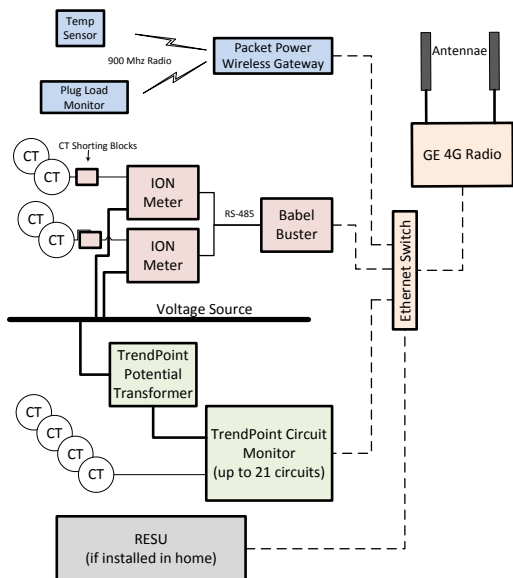

A3.4 TrendPoint Enersure System

The TrendPoint Enersure system is composed of a stack of circuit boards located in the home data collection cabinet that is connected to current transformers installed in the home electrical panel and subpanel. This system is capable of monitoring up to 21 separate 120 VAC circuits (ranging from 20 to 200 amps). There is also a potential transformer installed in the data collection cabinet that converts the 120 VAC signals to low voltage for use by the TrendPoint measurement boards. The CTs used for each circuit have internal resistors in them so low voltage signals are delivered to the TrendPoint boards and they do not require shorting blocks for safety. The Enersure system is capable of measuring amps, watts, watt-hours, volts, and power factor for each home circuit. Proper installation of the CTs and voltage selector jumpers is necessary to correctly measure power; this system is not capable of measuring reverse power. Data is sent to the 4G radio through Ethernet using the SNMP protocol.

A3.5 Schneider ION Metering System

The team installed up to two Schneider ION meters at each home. These meters allow measurement of two-way power flow and provide more detail than is possible with the TrendPoint Enersure system. The CES Block homes have one ION meter that measures the total home load. The ZNE Block and RESU Block homes have two ION meters to measure the total home load and RESU operations. The Control Block homes did not receive ION meters. The ION metering system is composed of the ION meter, CTs with shorting blocks, and the Babel Buster module that converted the ION meter's RS-485/Modbus connection to Ethernet/SNMP. The Babel Buster polls the ION meters and stores the results in a buffer. When the Babel Buster is polled by the TrendPoint back office server, it returns the latest value in its buffer. This system is capable of measuring a full range of two-way electrical values including amps, volts, watts, VARs, power factor, watt-hours, VAR-hours, harmonics, and frequency.

A3.6 Packet Power Wireless Sensor System

A Packet Power wireless sensor system is installed in each project home. This system is composed of a wireless gateway located on the exterior of the data collection cabinet, plug load monitors (PLMs) and temperature sensors. The wireless gateway is connected by Ethernet cable to the 4G radio through an Ethernet switch. The wireless sensors communicate with the wireless gateway through a 900 MHz radio network and are located throughout the home. The wireless sensors report to the wireless gateway to store the latest reading on a regular basis. The wireless gateway is then polled by the TrendPoint back office server and the latest value in the gateway buffer is retrieved. The PLMs report watt-hours, watts, frequency, amps, volt-amps, power factor, and volts. The temperature sensors only report temperature.

A3.7 General Electric 4G Radio Gateway

Each home data collection cabinet contains a 4G radio that communicates data from the local Ethernet network and makes a connection to the public carrier back office through the public 3/4G cell network. This radio gateway contains a 4G radio and has inputs for Ethernet, RS-232, and Wi-Fi. The radio also contains software that provides a connection to SCE's centralized cybersecurity system. Once the communications makes its way to the public carrier back office, it passes through a lease-line link to SCE's project back office servers in Alhambra.

A3.8 Back Office Systems

SCE houses a number of servers at its back office facility in Alhambra, California. These servers include:

- RESU SQL database (directly accessed for data)
- TrendPoint Smart Grid Management Console (data transferred to Oracle server)
- DEM for the CES (data transferred to Oracle server)
- BESS local server (data transferred to Oracle server)
- NMS for project smart meters (data transferred to Oracle server)
- Oracle (stores validated data from TrendPoint, DEM, BESS, and NMS servers)

All data is consolidated in SCE's back office, checked for errors, and transferred to an Oracle database for use by the ISGD team. Data from the RESU server is accessed directly. These servers are routinely backed-up and maintained by SCE's Information Technology department.

A3.9 Lessons Learned

Over the course of design, installation, commissioning, and operation of the data acquisition system, the team learned a number of lessons. The following is a listing of the major lessons and a description of what the project team learned.

A3.9.1 Local Data Storage Would Improve Data Retention

Wireless communications for retrieving data from the project homes has been unreliable, leading to lost data. This challenge has manifested itself in two ways: retrieving data from the wireless plug load monitors and temperature sensors within the project homes, and retrieving the data from the homes through the 4G radio system.

Since the plug load monitors and temperature sensors needed to be installed in existing homes on a retrofit basis, the team chose to retrieve the sensor data on a wireless basis. Unfortunately, some of the locations in the homes have poor connections to the wireless gateway in the garage. This has led to lost data from these sensors. Although some temperature data was lost, enough was recovered to determine the temperature trends in the homes for analysis. Temporary loss of communications with the plug load monitors led to some minor losses of kWh data. However, the plug load monitors contain a running counter for kWh, which allows the team to calculate usage data after restoring communications. A better design would have used local data storage at each sensor so data lost due to communications problems could be recovered later when the communications channel was working better. The instrumentation manufacturer has been to the sites and made suggestions on how SCE might improve data recovery through relocating the wireless gateway.

The team has encountered a similar problem retrieving data from the customer homes. All home data is retrieved through the 4G radio system. The cell coverage at some of the homes is weak, causing loss of communications at times. Because of how the home data collection package was designed, there is no local storage of data. This leads to the loss of data when the 4G cell communications fails. A better system design would have been to require some local storage so data lost during communications dropouts could be recovered later when the communications channel was working better. Changes have been made to the configuration of these radios to reduce the duration of the dropouts. With these changes, sufficient data is recovered to allow the required analyses to be performed.

A3.9.2 Retrofitting Current Transformers into the Customers' Electrical Panels Was Difficult Due to Space Constraints

The team is monitoring the circuits in each home using small clamp-on CTs. These CTs are placed in the customer's electrical panel and the leads routed back to the TrendPoint Enersure circuit monitor boards. Because of space constraints, these CTs are hard to fit in the panel and routing of sensor wires is difficult. This leads to a very crowded panel and misidentification of some of the leads as well as installation of the CTs in a reversed direction. Since the TrendPoint measurement board only measures power flow in one direction, any CT installed backwards or misidentified as to which leg of the panel it was connected to causes zero values for power and energy. Because of this, each panel needs to be verified and CTs or potential jumpers corrected to ensure proper recording of the data. This is very time consuming. A measuring system with either smaller CTs or the ability to switch potential settings or CT orientation remotely would have made installation easier. A system that would have measured power in either direction would also have made installation easier and obviated the need for the installation of the Schneider ION meters to observe two-way power flow.

A3.9.3 Installing Instrumentation in Existing Homes Is Difficult

Retrofitting instrumentation into homes is difficult and takes significant amounts of time. Once instrumentation is installed, it may take several more visits to the home to work out all of the bugs. This is difficult since it requires appointments with the homeowners to gain access. This slows the progress of correcting installation problems and makes it difficult to fix problems as they occur during the monitoring period.

A3.9.4 Understand How Instruments Can Fail and Use This to Help Validate Data

Understanding how the various communications paths can fail (and how this affects the data), can provide insights for identifying bad data or failed sensors. For example, a reading of zero might be caused by zero current flow, or it could be caused by a wireless sensor not reporting as expected. With an understanding of the failure mechanisms for each measurement system, data can be validated more easily.

Appendix 4: Project Home Floor Plans

Plan 751

- Two Story Hillside Home
- Approximately 1,900 Square Feet
- Three Bedrooms
- Two and a Half Bathrooms
- Great Room/Dining Room with Wood-Burning Fireplace
- Kitchen with Breakfast Nook
- Attached Two-Car Garage

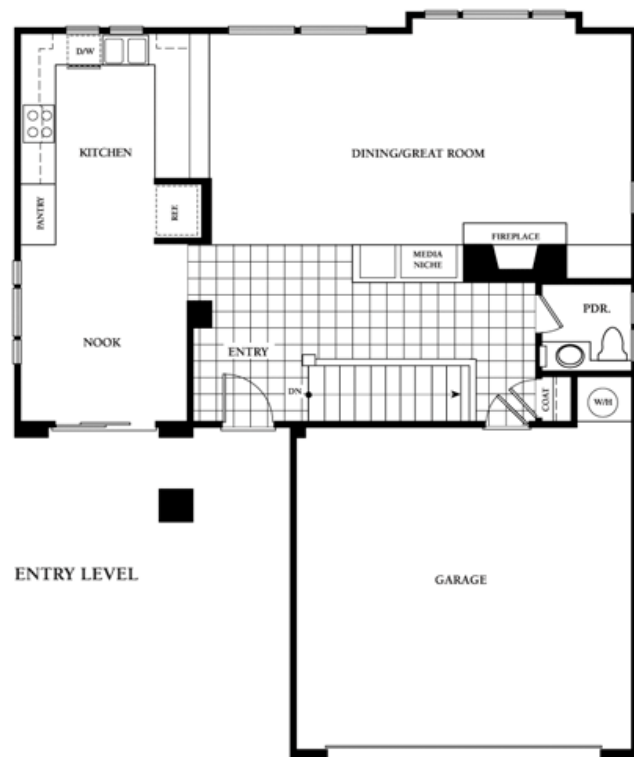

LOWER LEVEL

Plan 752

- Two Story Hillside Home
- Approximately 2,200 Square Feet
- Three Bedrooms plus Den
- Three Bathrooms
- Great Room/Dining Room with Wood-Burning Fireplace
- Kitchen with Breakfast Nook
- Inside Laundry Room with Sink
- Attached Two-Car Garage



Plan 753

- Two Story Hillside Home
- Approximately 2,500 Square Feet
- Five Bedrooms
- Three and a Half Bathrooms
- Family Room with Wood-Burning Fireplace
- Dining Area and Kitchen with Breakfast Nook
- Inside Laundry Room with Sink
- Attached Two-Car Garage



Plan 754

- Three Story Hillside Home
- Approximately 2,900 Square Feet
- Four Bedrooms plus Loft
- Three and a Half Bathrooms
- Wood-Burning Fireplace
- Dining Area and Kitchen with Island and Breakfast Nook
- Inside Laundry Room with Sink
- Attached Two-Car Garage

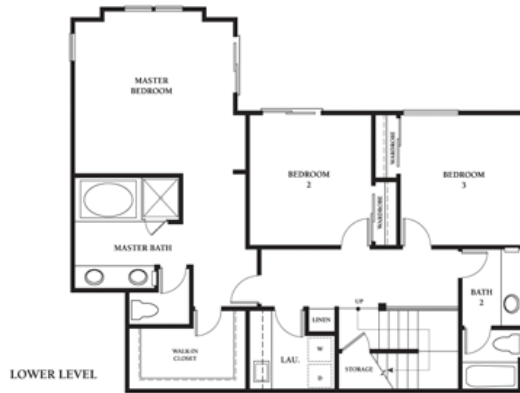

Appendix 5: ZNE Flyer Sample

ISGD PROJECT

The Path to Zero Net Energy

Implement these energy efficiency measures (EEMs) with photovoltaics and see how close your house can get to generating as much energy as it consumes!



SOUTHERN CALIFORNIA EDISON
An EDISON INTERNATIONAL Company



ZNE 3
Irvine, California

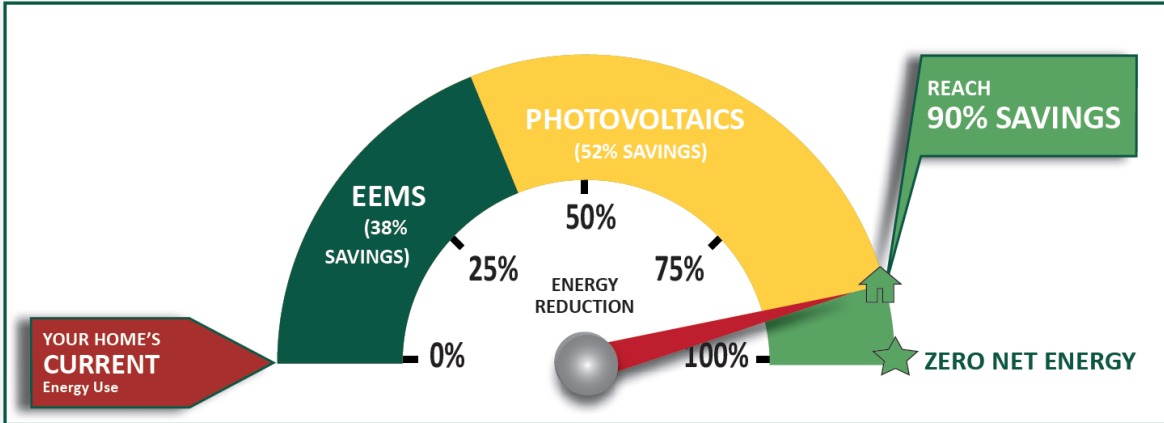

ENERGY EFFICIENCY MEASURES

CUSTOM	EEM 1 — LED lighting <i>Hard wired and stand up lamps will be replaced with the top of the line LED bulbs reducing energy consumption while maintaining excellent light quality.</i>
	EEM 2 — Heat pump <i>The furnace and AC (if the house has cooling) will be replaced with a 19 SEER/9 HSPF heat pump with electric resistance backup heat.</i>
	EEM 3 — 96% domestic hot water heater <i>The existing hot water heater will be replaced with a 96% efficient condensing gas water heater along with improved insulation.</i>
	EEM 4 — Solar hot water heater <i>Solar panels will be installed to provide domestic hot water heating.</i>
	EEM 5 — Plug load timers <i>Smart strips and timers will be installed to turn equipment off when you are away reducing energy consumed in low-power modes while you are not using it.</i>
	EEM 6 — Low flow showers <i>Your shower head will be changed from a 2.5 to 1.5 gallon per minute fixture to conserve water and decrease the amount of water you will need to heat.</i>
	EEM 7 — Duct sealing <i>Ducts will be sealed to increase the efficiency of your heating and cooling systems while also increasing the comfort in your home.</i>
	EEM 8 — Add R30 to the attic <i>Insulation will be added to the attic to reduce air leakage and infiltration, saving energy costs related to heating and cooling.</i>
STANDARD	EEM 9 — ENERGY STAR® appliances <i>Full-time use appliances will be replaced with ENERGY STAR appliances reducing energy consumption and offering significant savings.</i>
	EEM 10 — Photovoltaic array <i>Photovoltaics will be installed.</i>



ZNE 3
Irvine, California

YOUR HOME'S PERCENT SAVINGS
(compared to your current energy consumption)

90%
PER YEAR

Annual Energy Consumption/Generation Comparison

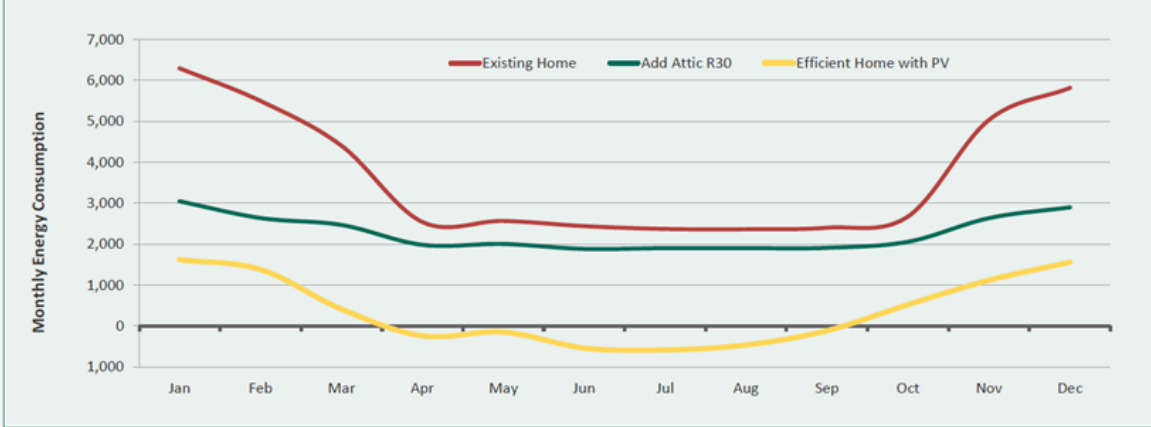

ELECTRIC — Monthly Energy Savings by Measure

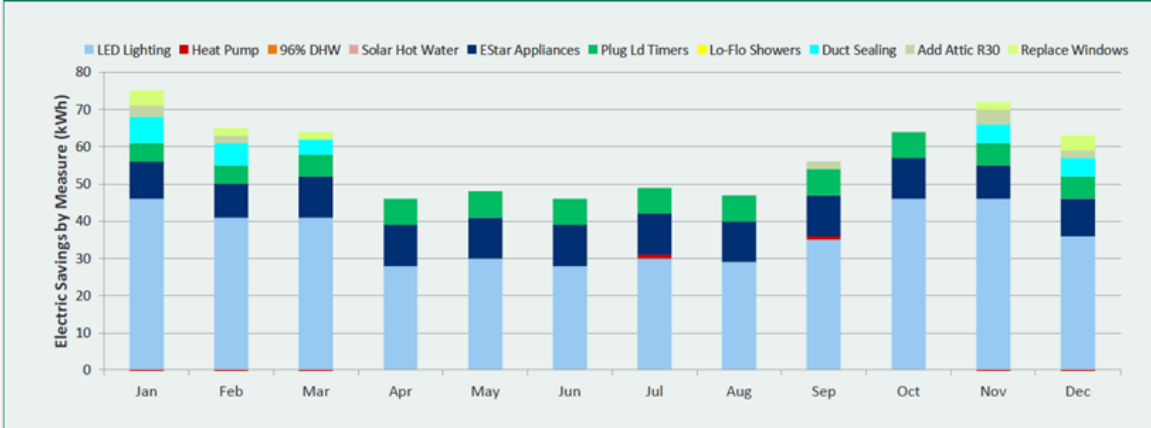

GAS — Monthly Energy Savings by Measure

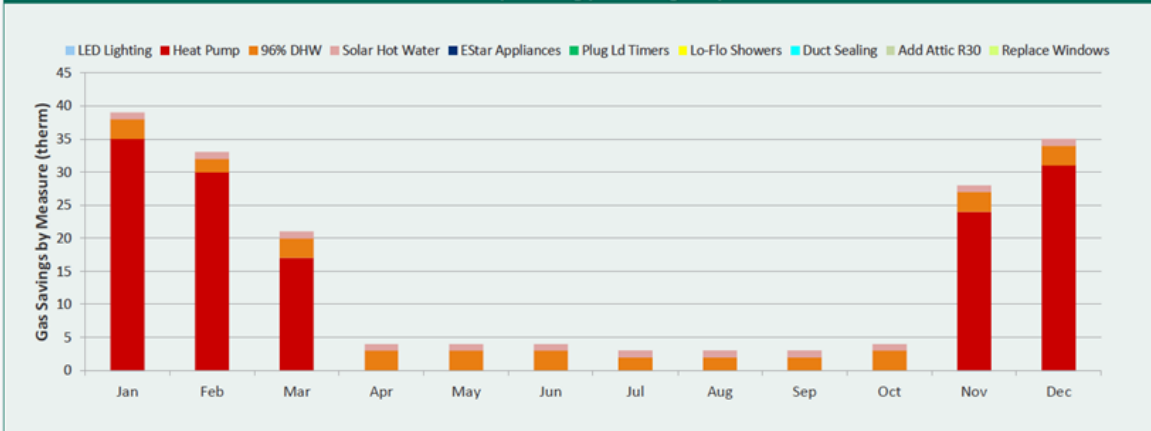

Appendix 6: Data Storage Requirements

A6.1 Introduction

This section contains findings and discussion related to the amount of storage required for operation of the ISGD systems.

The amount of storage required for systems like those used in ISGD varies greatly, depending on the number and frequency of readings or other parameters being collected and recorded, how many devices are deployed, what internal representation formats are used to persist the readings, and how many copies are made of that data. Furthermore, some data may need to be retained for several years, while some might be kept only for a few hours. Therefore, it is not a simple answer, but a simple example of a single measurement at one minute frequency could take over 100 megabytes (MB) per year. This equates to approximately 400 TB per year for SCE’s 4 million meters. Therefore, large systems with multiple devices—and multiple data points per device—can quickly get into terabyte (1,000 GB) and even petabyte (1,000 TB) scales.

A6.2 Schema

Each system has a schema, which consists of a set of files and tables used to store configuration data, including which devices are in use, where they are located, and what functions are enabled. The systems also have tables to store measurement readings taken by those devices, as well as status, configuration, and command parameters that can be recorded.

The largest amount of storage required for these types of systems will be in the data that is recorded on an ongoing basis. Configuration and reference data may be quite extensive and complex, but there will only be a few records per device. Recordings of measurements may occur at frequencies from every hour to sub-second, so this is the area on which to focus.

Through analysis of the various interfaces and internal structures on ISGD, it is clear there are many ways to store time-series data (values over time). All schemas used to record readings will need to have timestamps and values somewhere in the table structure. They will also require references to what each value means—namely, which device recorded the readings, and what do the readings mean? These attributes are called “location” and “reading type” in the discussion below. The main differences in schemas relates to where these references are located. In general, attributes can be distinguished using any of the structural elements of the storage platform, namely database instances, table names, column names, or values.

Reading Types in Columns

This type of schema stores one row per timestamp per device or internal component, along with all of the readings taken at that time, one value per reading type, with each reading type in a different column. **Table 43** provides an example.

Table 43: Readings Types in Columns Example

DEVICE_ID	TIMESTAMP	POWER_W	ACC_ENERGY_KWH	VOLTAGE_V
123	2014/11/07 14:37	23.6	28764.2467	124.3

Storing multiple values with a single timestamp does save space, since timestamps and device references are reused. However, this schema may not be as flexible as the alternative below, since the reading types are in the structure and therefore must also be in the associated code.

Reading Types in Values

This schema pattern stores one row per individual reading value, so the structure must contain references to the device taking the readings as well as the reading type that describes what the value means. It is possible to combine these and use an internally generated unique number (surrogate key) to identify the type, but the example below uses simple names for flexibility. **Table 44** provides an example.

Table 44: Reading Types in Values Example

DEVICE_ID	TIMESTAMP	READING_TYPE	VALUE
123	2014/11/07 14:37	POWER_W	23.6
123	2014/11/07 14:37	ACC_ENERGY_KWH	28764.2467
123	2014/11/07 14:37	VOLTAGE_V	124.3

One aspect about this arrangement is that all of the values must use the same data type, typically a decimal number. However, a system could have a few structures very similar to this, one for each value type, to allow for parameters that require a different data type, such as alpha-numeric character strings.

Regarding references to physical devices and installed locations, it is best to relate readings to the physical device that took the reading, and then relate physical devices to locations with effective dates. This way, it is possible to replace the device at a location and retain the ability to retrieve all readings at that location regardless of which device took those readings. For example, one device location association record might relate device D1 with location L1 from 1/1/2014 through 10/1/2014, and another record could link device D2 with location L1 after 10/1/2014. An important aspect of this is that the location does not change when the device changes, only the associated device per the effective dates.

A6.3 Time-Series Data Storage Sizes

The amount of storage required for a time-series type of system can be roughly estimated using the size of each record, number of devices, reading types per device, and frequency of readings. This section describes typical attribute storage sizes, and the following section provides a method to compute storage requirements.

Timestamp

There are two common internal storage formats for timestamps: one with a time zone, and one without a time zone. Inclusion of time zone is required for a system that is to be configured across multiple time zones, as well as for accurate reporting on days when the time zone offset changes due to daylight savings time.

- Decimal days / fractional seconds / no time zone (8 bytes)
- Timestamp with time zone (13 bytes)

References

The amount of storage required for the references to a specific device and reading type can vary greatly across systems, depending on how the references are modeled in the schema. This list provides a few examples for comparison purposes. For example, a system might store unique device and reading type identification keys along with the timestamps and values, or it could store a character string that uniquely describes the measurement point.

- Unique key(s) (4-8 bytes)
- Character field(s) for descriptive names (50-250 bytes)

The minimal representation would keep key references to other structures containing more descriptive names. An example of these references from the schema examples is "POWER_W measured by Device 123." **Figure 72** shows

one possibility, such that the descriptive character string names and attributes about the devices and reading types are kept separately so they don't have to be stored with each reading. The "id" fields can be short, 4-byte integers, whereas the attributes such as device manufacturer can be hundreds of bytes.

Figure 72: Reference Model Example

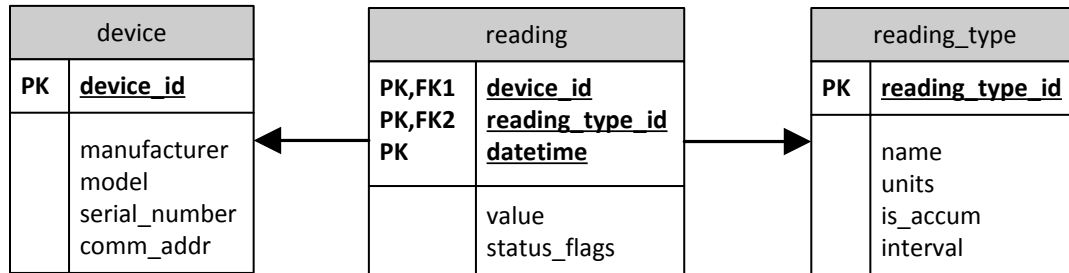

There are many ways to model this relationship. Another way is to have an intermediate table between reading values and devices and reading types called a *reading channel*, for example, that uses a single key to link back to the additional device and reading type information, as in **Figure 73**.

Figure 73: Reference Model Example Using an Intermediate Table

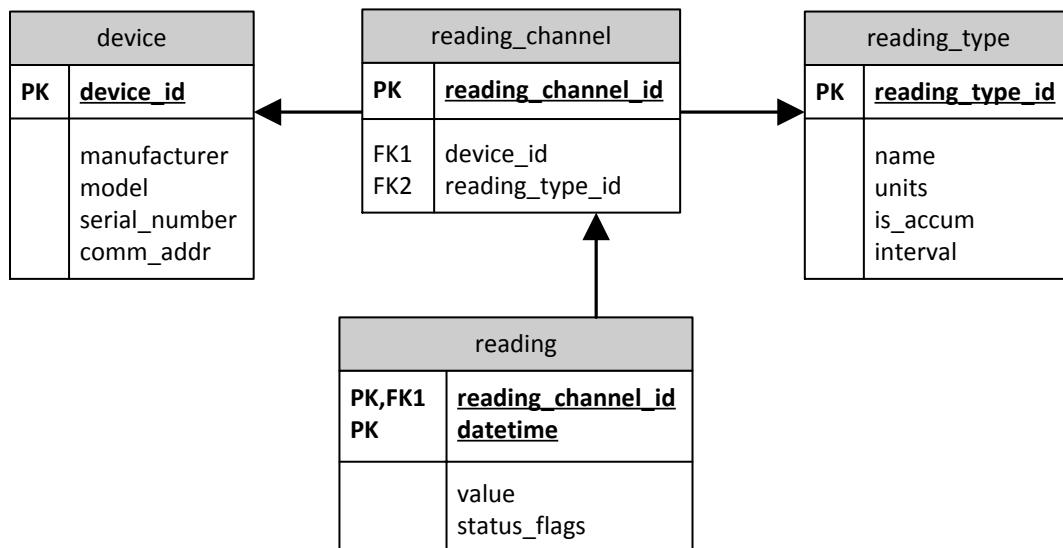

Value

- Typical size for a precise, decimal number is 8 bytes

Status

A few bytes can be useful to denote various qualities, such as whether the data is raw, estimated, calculated, valid, or invalid (whatever status qualities are desired can be defined).

- Reading value quality status (2 bytes)

A6.4 Storage Estimation

The minimum amount of storage per reading (without adding multiple types to the structure) is around 20 bytes. A large size would be 200 bytes or more. The general formula for estimating the storage requirements of a system is shown below.

$$\text{Number of points across all devices} * \text{Size per point} * \text{Frequency of readings} = \text{Storage estimate}$$

For example, a million points (e.g. 10 reading types at each of 100,000 locations) at five minute intervals would give 288 million readings per day, times 365 days is 105,120,000,000 readings per year, and then multiplied by a “typical” size of 120 bytes per reading is 12,614,400,000,000 bytes per year, or 12.6 TB/year. Also, storage will be required for indexes, which are used to speed up retrieval queries, adding up to around half of the size of the data itself.

An example from the ISGD project is the meter data storage database, which is recording 5-minute data for 394 points, and hourly data for another 122 points, and is using around 22 MB per day of primary storage, including indexes. Dividing 22 MB by the 116,400 readings per day shows that it is using around 189 bytes per reading. This number could then be used to estimate storage for a different number of devices, readings, or frequencies.

It will be necessary to store each reading multiple times. A backup copy will be needed, in case the primary storage fails. This could be done using disk arrays and mirroring, database backups, or both. Additionally, any new system that will provide functionality using the readings as input will usually require a separate copy, since that application code will require a specific schema structure for processing that is tailored to the needs of that application.

A6.5 Storage Reduction

Some systems have methods for minimizing storage requirements. A typical feature of “time-series” data historians is that they will only store readings that differ from a function that uses historical point values to determine future ones, such as simply following the slope of a line. Depending on the sophistication of this process, and the complexity of the readings, it may be possible to save a large percentage of this estimated storage requirement.

Another strategy is to selectively collect and/or store “interesting” time periods with greater frequency. For example, one second or even faster samples could be saved locally in the device for some period of time, but be discarded unless requested within some time frame, for example if there is an event of some type in the area.

A common scenario is that the most accurate representation of the system is needed for only a short time, and by the fewest functions and people. As the measurements age, more people might want them, but they might only need a summary of the data—maybe a representative sample at full resolution along with aggregate totals at a longer interval resolution.

Appendix 7: Deep Grid Situational Awareness Adaptive Filter and ANN Algorithm Design

A7.1 Adaptive Filter

In designing filters, it is assumed that the statistical characteristics of the input signal (including the correlation matrix and cross-correlation) are known and that the filter is optimum when the input signal's characteristics matched the information on which the filter is based. Adaptive filters automatically adjust their coefficients based upon the input signal. There are two kinds of processes that occur in an adaptive filter. An adaptive or training process that is responsible for automatically adjusting the filter coefficients and a filtering or operating process that uses the filter coefficients from the adaptive process to produce an output signal are both included in the adaptive filter.

An adaptive filter can be described as shown in Equation (1), which shows the update equation which that is the basis of adaptive filtering. The problem becomes writing an algorithm to compute the change in the filter's unit sample response, $\Delta \mathbf{w}_n$, that occurs between time-steps n and $n+1$ based upon the problem at hand (w is the filter's unit sample response).

$$\mathbf{w}_{n+1} = \mathbf{w}_n + \Delta \mathbf{w}_n \quad (1)$$

A7.1.1 FIR Adaptive Filter (Based on Wiener Filter)

One method of designing adaptive filters is to use Wiener method. A Wiener filter is used to produce an estimate of a desired or target random process by linear time-invariant filtering of an observed noisy process, assuming known stationary signal and noise spectra, and additive noise. The Wiener filter minimizes the mean square error between the estimated random process and the desired process by matrix multiplication of the noisy signal \mathbf{w}_n by the autocorrelation matrix, $\mathbf{R}(n)$, to produce the clean signal $\mathbf{p}(n)$ as in Equation (2). Using the same procedure as previously discussed we have:

$$\mathbf{R}(n)\mathbf{w}_n = \mathbf{p}(n) \quad (2)$$

For wide-sense stationary processes Equation (2) is reduces to Wiener-Hopf equations shown in Equation (3). In a more general case, \mathbf{w}_n is a function of time. To solve this problem a well-known optimization approach called the steepest descent algorithm is used.

The steepest descent adaptive filter

The goal is to find a \mathbf{w}_n vector w_n that minimizes the function in Equation (3) at time n . One way is to use the method of steepest descent which is an iterative procedure to find the optimum of a non-linear function. If \mathbf{w}_n is the estimate of the vector that minimizes ξ_n at time n , at time $n+1$ a new estimate is made by adding a correction to \mathbf{w}_n . The correction involves taking a step of size μ in the direction of maximum descent sown that is present on the quadratic surface. This direction is given by the gradient vector. This will result in Equation (4).

$$\xi_n = E\{|e(n)|^2\} \quad (3)$$

$$\mathbf{w}_{n+1} = \mathbf{w}_n - \mu \nabla \xi(n) \quad (4)$$

Further manipulation of Equation 4 will result in:

$$\mathbf{w}_{n+1} = \mathbf{w}_n + \mu(\mathbf{p} - \mathbf{R}\mathbf{w}_n) \quad (5)$$

To make sure that the algorithm converges and is stable, the step size cannot take any arbitrary value and has the following constraint:

$$0 < \mu < \frac{2}{\lambda_{max}} \quad (6)$$

Where λ_{max} is the maximum eigenvalue of the autocorrelation matrix R. In this algorithm it is necessary to know $E\{e(n)\mathbf{u}^*(n)\}$, which means knowing the autocorrelation matrix of $\mathbf{u}(n)$ and the cross-correlation between the desired output and $\mathbf{u}(n)$. Since in most cases these ensemble averages are not known, they must be estimated from the data, which is done in the Least Mean Square (LMS) algorithm.

LMS algorithm

In this algorithm $E\{e(n)\mathbf{u}^*(n)\}$ is estimated as the sample mean as follows:

$$\hat{E}\{e(n)\mathbf{u}^*(n)\} = \frac{1}{L} \sum_{l=0}^{L-1} e(n-l)\mathbf{u}^*(n-l) \quad (7)$$

If only a one-point sample is used, i.e., $L=1$, we have:

$$\hat{E}\{e(n)\mathbf{u}^*(n)\} = e(n)\mathbf{u}^*(n) \quad (8)$$

And thus:

$$\mathbf{w}_{n+1} = \mathbf{w}_n + \mu e(n)\mathbf{u}^*(n) \quad (9)$$

which is known as the LMS algorithm. The stability of the algorithm depends upon the step size and for un-stationary processes it is difficult mathematically to find an expression to guarantee stability. To solve this issue, a normalized step size is typically usually used as shown in Equation (10).

$$\mu(n) = \frac{\beta}{\|\mathbf{u}(n)\|^2} \quad (10)$$

A7.1.2 Adaptive Recursive Filter

Recursive filters (i.e., filters that determine the next term of a sequence using one or more of the preceding terms), have an advantage over non-recursive filters in providing better performance. If the filter output is given by Equation (11), the problem becomes finding Θ that will minimize the mean square error. The steepest descent method is used to find optimum \mathbf{a} and \mathbf{b} , and if the ensemble averages are not known, the LMS method is used to further solve the problem.

$$y(n) = \mathbf{a}^T \mathbf{y}(n-1) + \mathbf{b}^T \mathbf{x}(n) = \Theta^T \mathbf{z}(n) \quad (11)$$

$$\Theta = \begin{bmatrix} \mathbf{a} \\ \mathbf{b} \end{bmatrix} \quad (12)$$

$$\mathbf{z}(n) = \begin{bmatrix} \mathbf{y}(n-1) \\ \mathbf{x}(n) \end{bmatrix} \quad (13)$$

This method basically uses previous algorithm results to recursively find the filter coefficients that minimize the mean square value of the error for predicting the next result.

A7.1.3 Recursive Least Squares (RLS)

So far the method has been described for finding the minimum of the mean-square error as shown in Equation (3). The challenge with application of the method as described above is that the statistical characteristics of the input and the desired output must be known or estimated. This can cause very slow convergence or not small enough

mean-square errors. One approach for dealing with this problem is to use a method that does not include the expectations of known characteristics and that can be directly computed from the data. One method is using a least squares error approach as shown in Equation (14). One must pay attention to the difference between minimizing the least square errors and the mean square error.

$$\epsilon(n) = \sum_{i=0}^n |e(i)|^2 \quad (14)$$

The derivation of the optimum filter coefficients in this case is the same as that described above for the previous filter but instead minimizing Equation (14). For an exponentially weighted RLS with λ being the exponential weight, the procedure can be summarized as shown in Equations 15-19.

$$\mathbf{z}(n) = \mathbf{P}(n-1)\mathbf{u}^*(n) \quad (15)$$

$$\mathbf{g}(n) = \frac{1}{\lambda + \mathbf{u}^T(n)\mathbf{z}(n)} \mathbf{z}(n) \quad (16)$$

$$\alpha(n) = d(n) - \mathbf{w}_{n-1}^T \mathbf{u}(n) \quad (17)$$

$$\mathbf{w}_n = \mathbf{w}_{n-1} + \alpha(n)\mathbf{g}(n) \quad (18)$$

$$\mathbf{P}(n) = \frac{1}{\lambda} [\mathbf{P}(n-1) - \mathbf{g}(n)\mathbf{z}^H(n)] \quad (19)$$

To achieve this task, an adaptive filter using RLS appears to be the best choice for the current algorithm development for detecting the dispatch of DER in distribution circuits. An adaptive filter is a filter that self-adjusts its transfer function according to an optimization algorithm driven by an error signal. The adaptive filter uses feedback in the form of an error signal to refine its transfer function to match the changing parameters. MATLAB's DSP system toolbox is used for development and testing of the algorithm. This toolbox provides several techniques for the design of adaptive filters: for example, LMS-based, RLS-based, affine projection, fast transversal, frequency-domain, and lattice-based. The system toolbox also includes algorithms for the analysis of these filters, including tracking of coefficients, learning curves, and convergence.

A necessary step that is required to verify that the RLS-based adaptive filter is indeed the correct choice for our purposes would be to finish designing the filter with actual parameters of the input data (synchrophasor data). Determining whether addition of the battery discharges the statistical characteristics of the signal or not and if it does affect the signal then determining how much it affects the signal, can be used to simplify the filter. If the battery affects the frequency even by a very small magnitude, then a frequency-domain filter might be more suitable, for example.

A7.1.4 Initial Application to Phasor Data

Phasor data associated with a demand response event for the Devers substation were provided to UCI. The filter was used for these data to see the event. Since the mentioned substation is on the transmission level, the best metric to evaluate the change in demand was determined to be the difference in phase angles at various buses. **Figure 74** shows the real power measured at Devers II substation. At time t=3 minutes, the first demand response signal is sent and some air-conditioning units are turned off and two minutes later another signal is sent and more units are turned off or down. At time t=10 minutes, the system goes back to business as usual operation and the demand response event is over. **Figure 75** shows the frequency.

Figure 74: Real Power (MW)

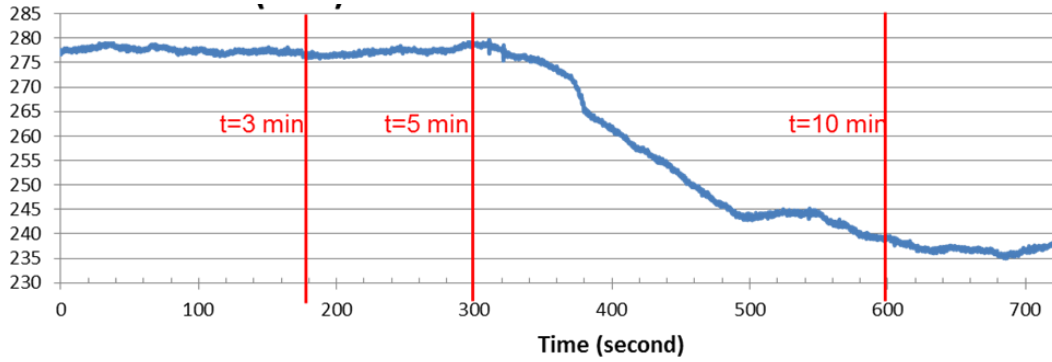
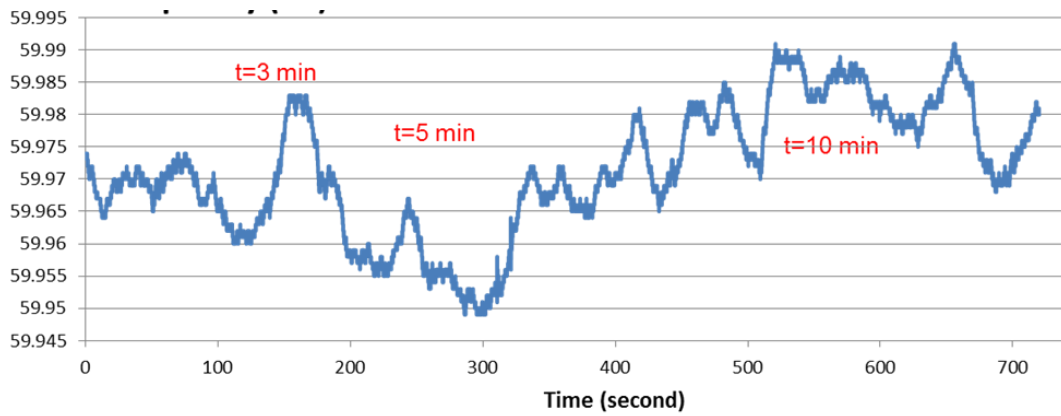
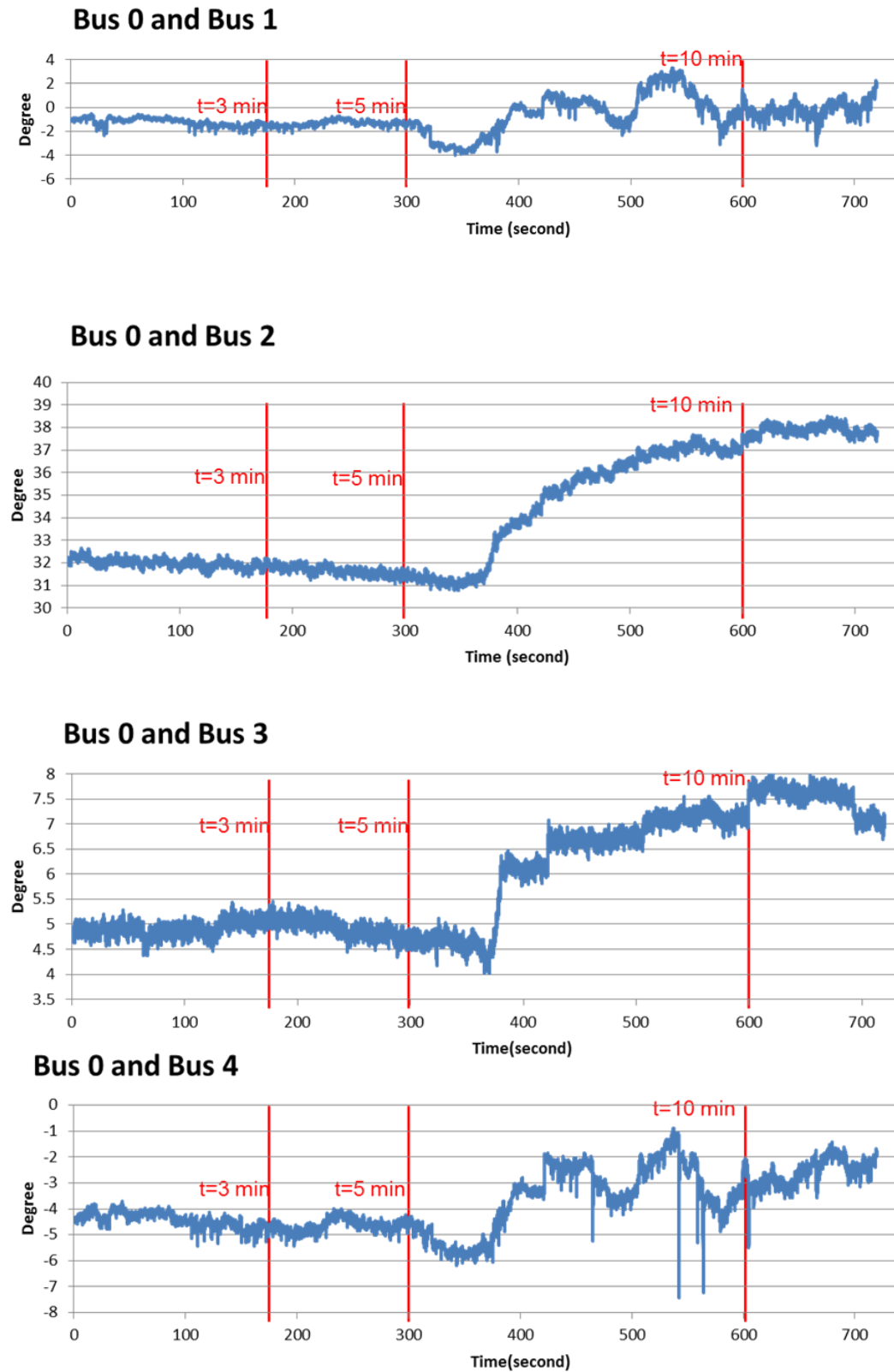

Figure 75: Frequency (Hertz)



In **Figure 76** the phase angle difference between a bus at the Devers substation and buses at other substations are shown. It can be seen that with this amount of data (~700 seconds of data) to design the parameters of the filter, the filter is not capable of removing all the noise, but the change in the angle difference can be observed nonetheless and the change in the load can be detected.

Figure 76: Phase Angle Differences between Bus 0 in Devers Substation and Adjacent Substations



It must be mentioned that in the event studied, the change in the demand is significant enough that it can be detected by only passing the data through a filter and reducing the noise. As such, a change of this magnitude can be observed without the need for a forecasting scheme.

A7.2 Artificial Neural Network Application

Artificial neural networks have been used for short-term electricity demand forecast. Phasor data were collected from the MacArthur Substation including the voltage magnitude and angle and current magnitude and angle. From these data the real power associated with the Rommel and Arnold circuits were calculated. The initial set of data to which the ANN algorithm was applied includes 30 samples per second for one hour starting at 22:16:58 GMT (2:16 PM local time) on 12/05/2013. The results are shown in **Figure 77** and **Figure 78** for the Arnold and Rommel circuits respectively.

Figure 77: Arnold Circuit Real Power for One Hour Starting at 2:16:58 on 12/5/13

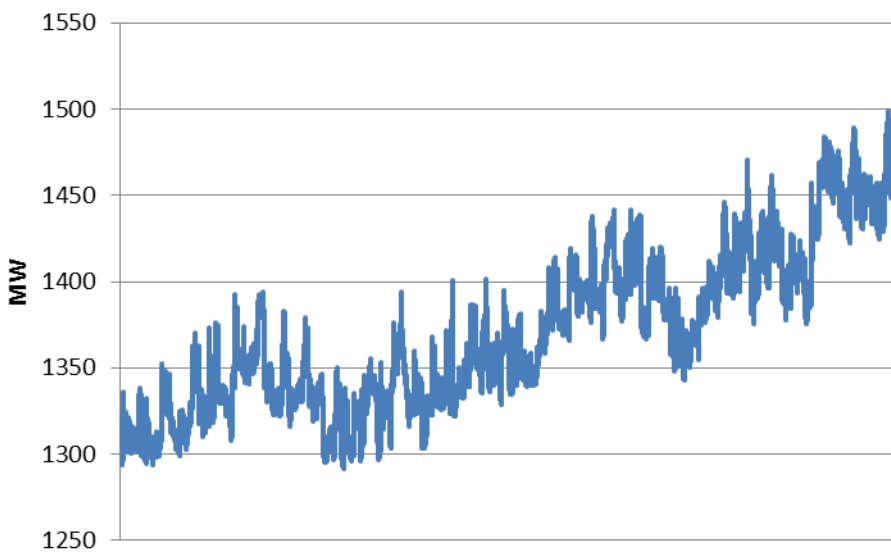
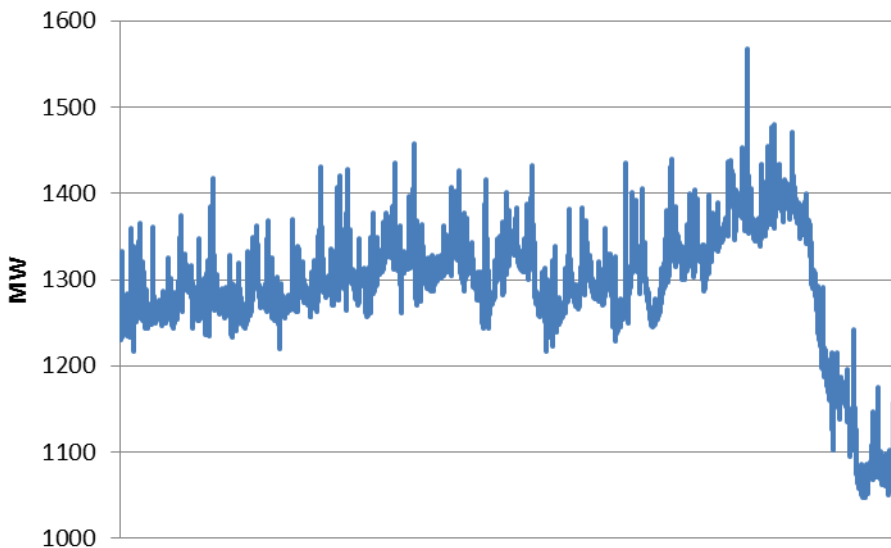

Figure 78: Rommel Circuit Real Power for One Hour Starting at 2:16:58 on 12/5/13



MATLAB has an ANN toolbox that includes various tools, one of which is the dynamic time series tool which is used here. The real power associated with the Arnold and Rommel circuits are put into appropriate format and imported into the Neural Network Time Series Tool in order to train the algorithm using a Levenberg-Marquardt back-propagation. Because data for only one hour is used in this case, an algorithm has been chosen that forecasts the next time step value based on previous values. With a larger data set, this can be changed to include both the previous values and also time of day. The algorithm can be trained to recognize both the time of day and season. **Figure 79** shows the summary window after the training has been completed using the one hour of Arnold circuit data.

Figure 79: Neural Network Training Summary

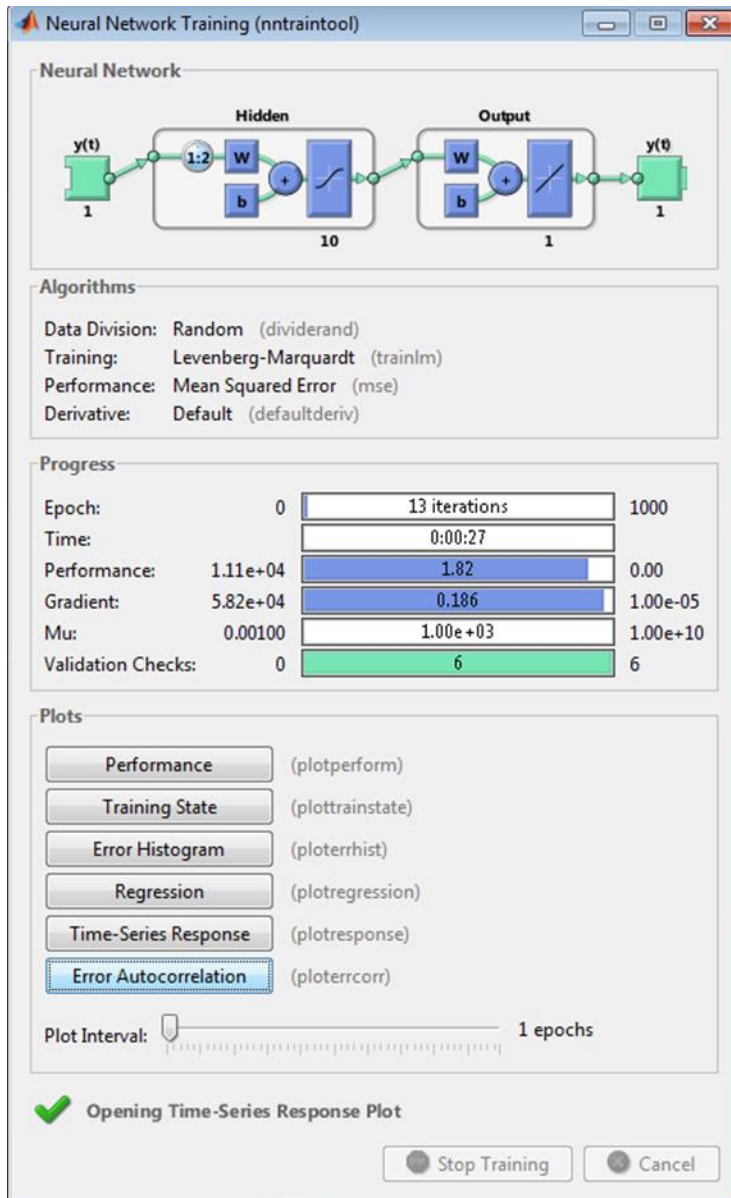
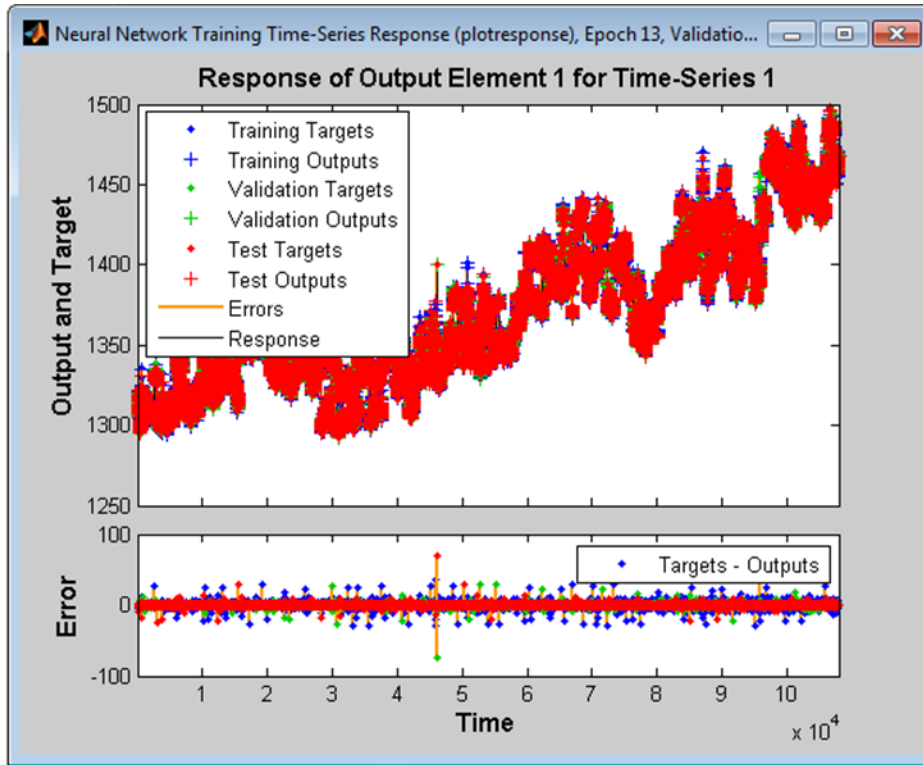
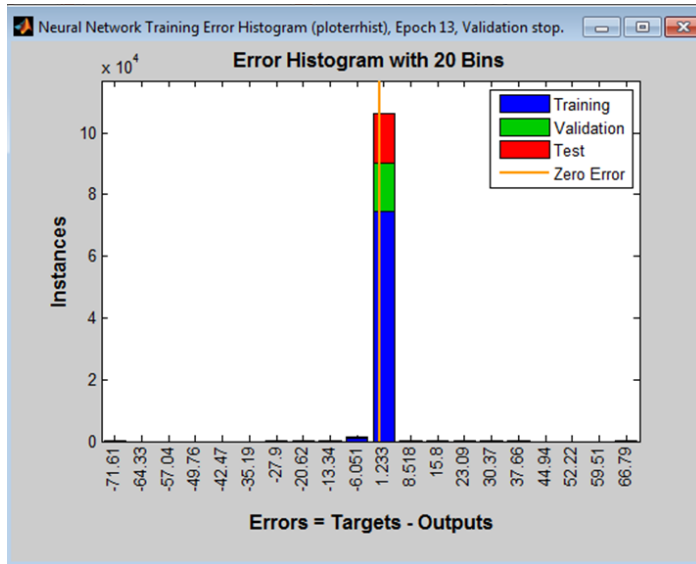

Figure 80: Neural Network Training Results for Arnold Circuit



In **Figure 80** the results for the Arnold circuit are shown with the number of delays $d=2$ and the error histogram is shown in **Figure 81**. As can be seen in **Figure 80**, the errors can be high with $d=2$ and only 1 hour of data to train the algorithm. With more data, especially data that includes the complete diurnal behavior of the circuit, the same procedure with different delays and parameters should be repeated, with hopefully better results. Also, the effects of initial conditions on the training and forecast should be studied. The relationships between behavior and time of day and season and the effects that feedback would have upon performance will also be added to the approach when more data becomes available.

Figure 81: Error Histogram for Arnold Circuit



A7.3 Data Management and Analysis

The PMUs installed at the MacArthur substation record 30 samples per second. These data include but are not limited to the timestamp (in UTC), both voltage and current magnitudes and angles associated with 12 kV Rommel circuit and 12 kV Arnold circuit. Each file includes data associated with one hour and includes 108,000 rows.

APEP provided an FTP server in order to make the transfer of data between SCE and APEP both fast and efficient.

A script in MATLAB was developed which is capable of connecting to the FTP server and downloading any newly uploaded files. This script also saves the files in MATLAB directory and unzips the folders and saves the unzipped file in one folder. This folder will include all the data collected at the MacArthur substation starting January 20, 2014. All these steps will be done automatically by simply running the developed MATLAB script.

Another MATLAB code was also developed which reads all the data from various files between two dates determined by the user and saves the data associated with the timeframe between those two dates in one matrix. The MATLAB workspace including that matrix is then saved in order to avoid uploading the data into MATLAB repeatedly.

The real power data associated with the Arnold circuit starting at 4:00 pm on February 9, 2014 for one week are shown in **Figure 82**.

Figure 82: Arnold Circuit Real Power Starting at 4 PM (2/9/14)

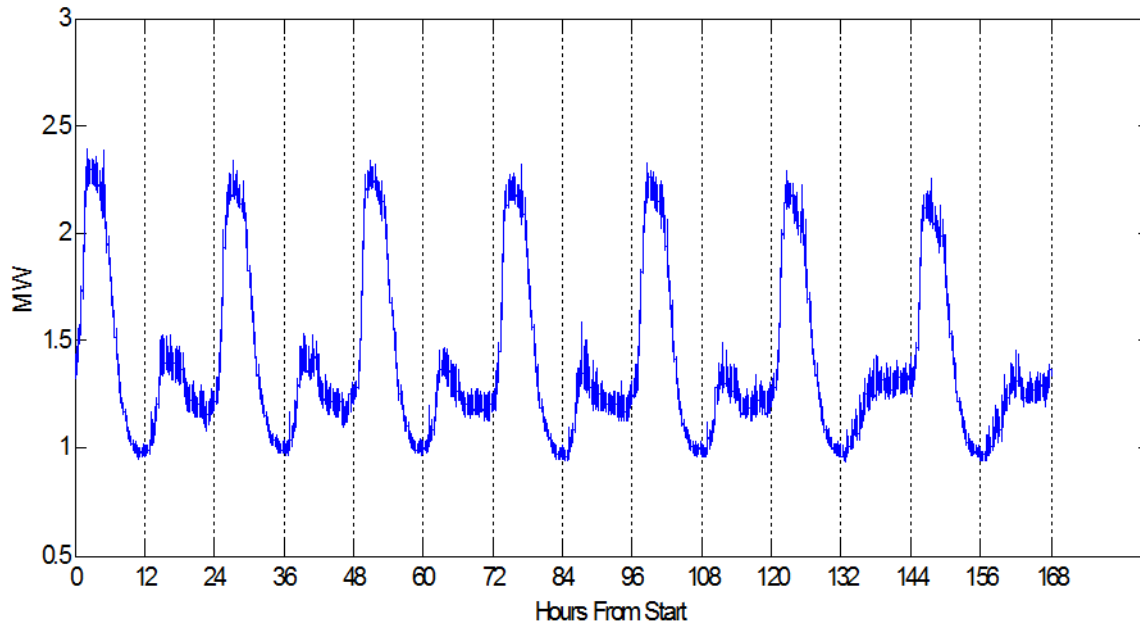

It must be emphasized that an efficient method for handling the data is crucial, especially for this task, because the data are being recorded at a rate of 30 samples per second and manual management of such a large set of data can be extremely time-consuming.

A7.4 Integration Method

This section describes how the adaptive filter, data management, and ANN algorithm are integrated to accomplish the overall purpose of detecting DER dispatch in a distribution circuit. The adaptive filter is capable of removing the noise from the signal and its coefficients automatically change based upon the input signal as described above. The ANN algorithm is capable of forecasting the signal for the next time-step. Three methods were explored for integrating the developed filters and algorithm into a method/model to fulfill the objective of this task. The first method is shown in **Figure 83**. In this figure, it is assumed that the algorithm starts with business as usual operations and without the battery. The signal first passes through the adaptive filter and the noise from the signal is eliminated. Then the signal enters the ANN which has been trained for normal (business as usual) operations. The output of the ANN is the forecasted data for the next time-step, which is compared to the actual data collected later (after it too has passes through the adaptive filter). The forecasted and actual data are compared to determine whether the battery has been dispatched or not. If not, the same exact process is repeated for the following time-step. If the battery has indeed been dispatched (charge or discharge), for the next time step the normal operations ANN will be replaced with another ANN algorithm that has been trained for operations involving the DER (in this case, the battery). At the end of this step if the battery is still being dispatched the process will be repeated with the ANN for DER operation. This will continue until the battery is not dispatched anymore. At this point, the duration of the battery operation and the MWh are recorded and for the next time-step the algorithm will reset and the process shown in **Figure 83** will be repeated from the beginning.

Figure 83: Overall Solution Method I

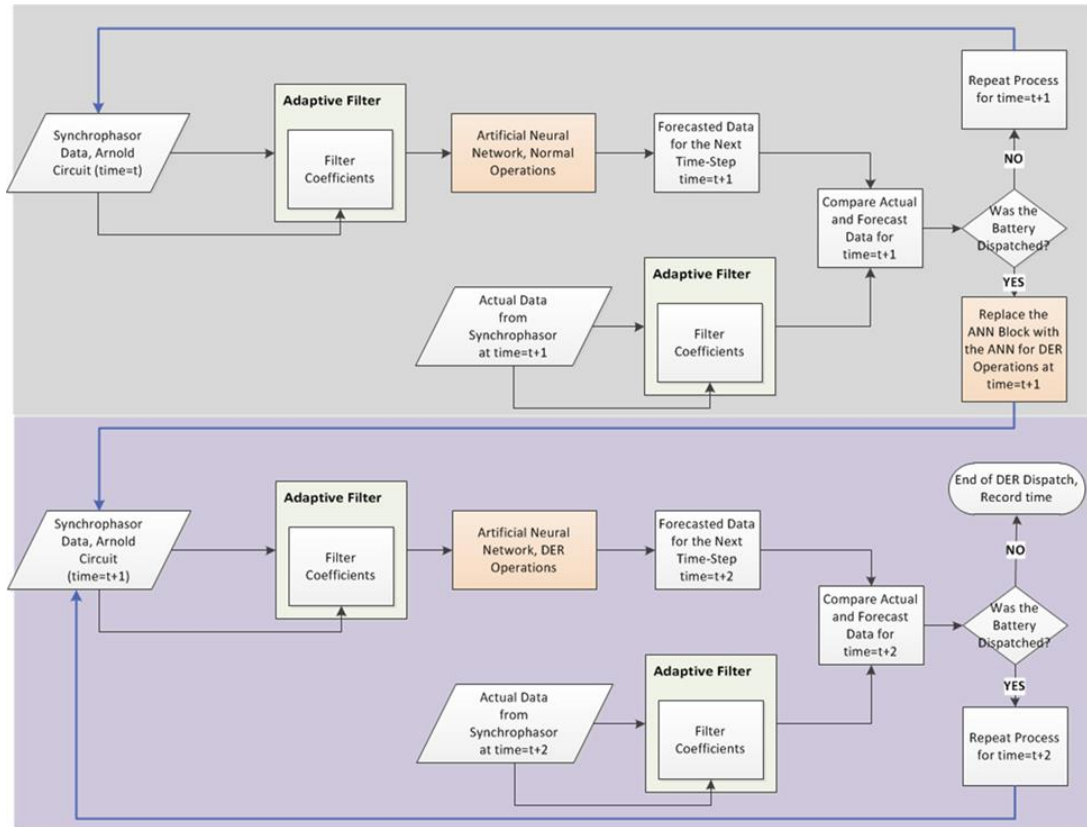

In the next method, which is a simpler approach to the integrated model, the signal from the other 12 kV circuit connected to the MacArthur substation (Rommel circuit) is used as a base signal for comparison because this circuit exhibits behavior similar to Arnold, but without the DER (battery). For this method to work it must be assumed that the behavior of Rommel is very similar to the Arnold circuit except for the 2 MW battery storage. The data for the two circuits are monitored, filtered, and compared at each time step (see **Figure 84**). When the Arnold circuit signal diverges significantly from the base signal (here the Rommel circuit), it can be concluded that the battery is being dispatched. This method is much simpler to implement compared to method I and it is also faster and can be used as a preliminary approach. Whether the Rommel circuit can be used as the base signal for comparison will be studied further in the project. This approach is shown in **Figure 84**.

Figure 84: Overall Solution Method II

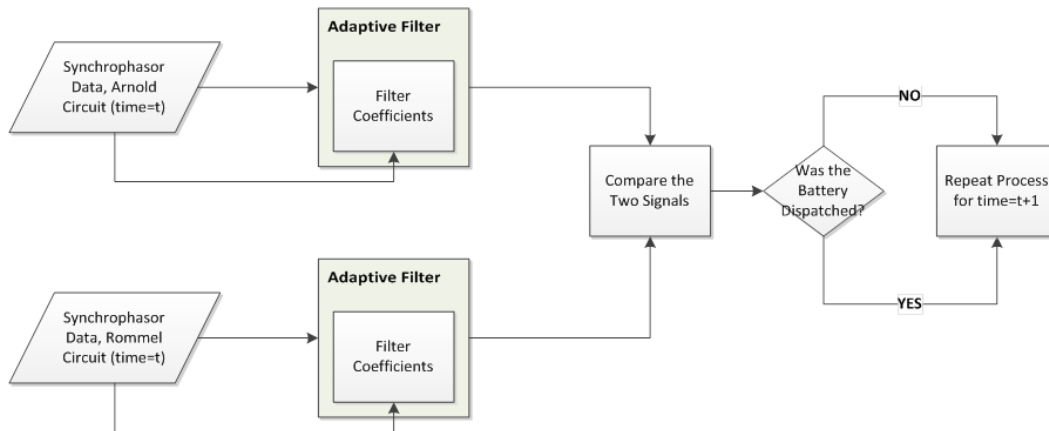

A third method includes a combination of method I and method II. In this method, the signals from the Arnold and Rommel circuits are passed through adaptive filters (the coefficients of these two filters are different and calculated based upon the data collected from each of the respective circuits), and then the difference between the two signals is calculated. The difference between the two signals at the next time-step is forecasted by an ANN trained using the signal difference. This forecasted signal is then compared to the actual signal measured by synchrophasors at the next time-step. Comparing the forecasted and actual signal, one can conclude whether the battery is being dispatched. If not, the exact same process will be repeated for the next time step. If the battery is being used, the ANN will be replaced by one trained for operations with DER until the battery cannot be detected anymore and the process will be reset. This method is shown in Figure 13.

These three methods will be compared to one another later when the tests including the battery charging and discharging are accomplished.

Figure 85: Overall Solution Method III

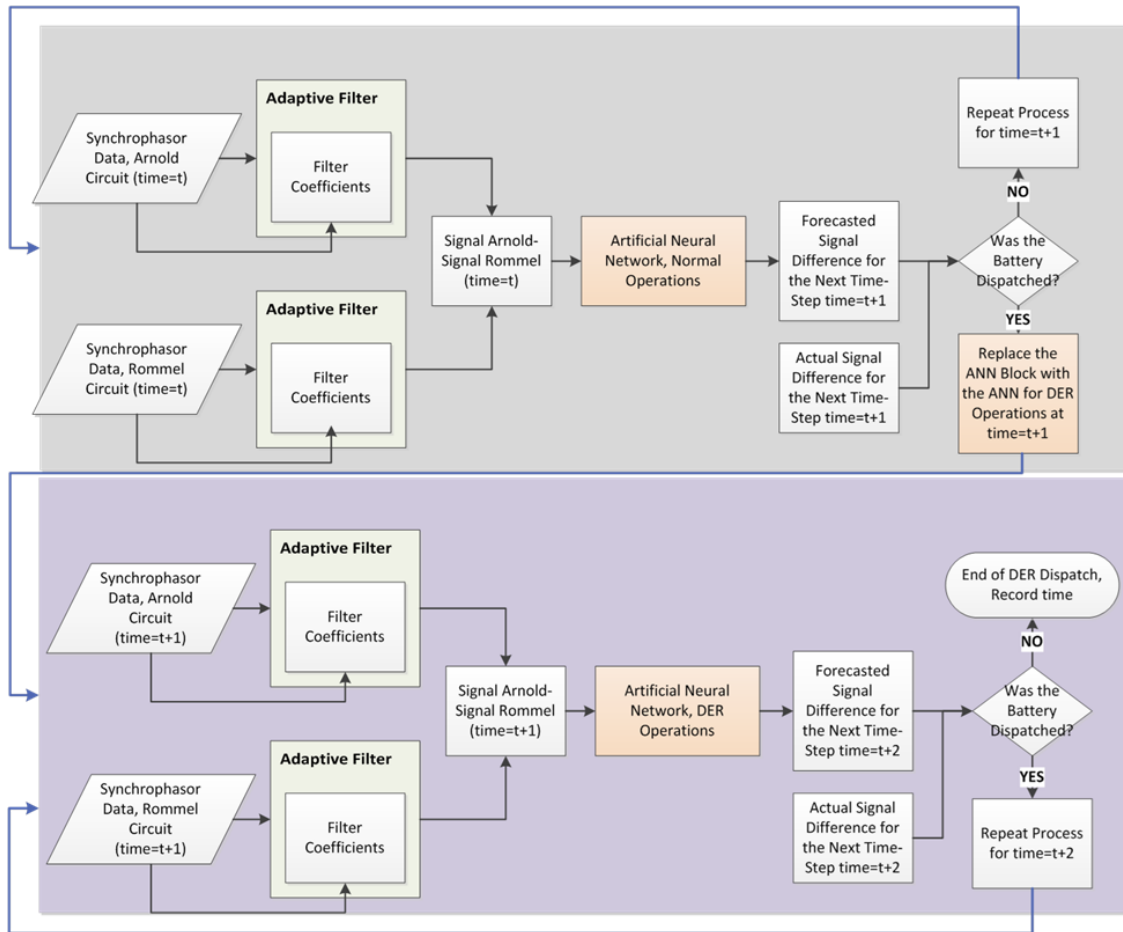

A7.5 References

1. US National Energy Technology Lab, Smart Grid Primer. 2006
2. FERC, <http://www.ferc.gov/industries/electric/indus-act/smart-grid.asp>.
3. Bhatt, N.B. Role of synchrophasor technology in the development of a smarter transmission grid. in Power and Energy Society General Meeting, 2011 IEEE. 2011.
4. Moxley, R. and D. Woodward, Improving Power System Operating Capacity through Wide-area Synchronous Phase Angle Measurement, in International Energy Transmission & Distribution Conference (7th : 2003 : Adelaide, S.Aust.)2003, Waldron Smith Management: Port Melbourne, Vic. p. [2299]-[2312].
5. Schulz, R.P., L.S. VanSlyck, and S.H. Horowitz. Applications of fast phasor measurements on utility systems. in Power Industry Computer Application Conference, 1989. PICA '89, Conference Papers. 1989.
6. <http://certs.lbl.gov/certs-eipp>.
7. <https://www.naspi.org/>.
8. <http://energy.gov/oe/technology-development/smart-grid/recovery-act-smart-grid-investment-grants>.
9. Novosel, D., K. Vu, V. Centeno, S. Skok, and M. Begovic, Benefits of Synchronized-Measurement Technology for Power-Grid Applications, in Proceedings of the 40th Annual Hawaii International Conference on System Sciences2007, IEEE Computer Society. p. 118.
10. North American Electric Reliability Corporation (NERC), Real-Time Application of Synchrophasors for Improving Reliability. 2010
11. Initiative, N.A.S., Actual and potential phasor data applications. <https://www.naspi.org/>,

12. Sykes, J., K. Koellner, W. Premerlani, B. Kasztenny, and M. Adamiak. Synchrophasors: A primer and practical applications. in Power Systems Conference: Advanced Metering, Protection, Control, Communication, and Distributed Resources, 2007. PSC 2007. 2007.
13. Madani, V., K. Martin, and D. Novosel, Synchrophasor standards and guides, PSTT and IEEE PSRC, Editor 2011: NASPI General Meeting.
14. Schweitzer, E.O. and D.E. Whitehead. Real-world synchrophasor solutions. in Protective Relay Engineers, 2009 62nd Annual Conference for. 2009.
15. Premerlani, W., B. Kasztenny, and M. Adamiak, Development and Implementation of a Synchrophasor Estimator Capable of Measurements Under Dynamic Conditions. Power Delivery, IEEE Transactions on, 2008. 23(1): p. 109-123.10.1109/tpwrd.2007.910982